

Fact Sheet for NPDES Permit WA0029181

West Point Wastewater Treatment Plant (WWTP) and Combined Sewer Overflow (CSO) System

December 19, 2014

Purpose of this fact sheet

This fact sheet explains and documents the decisions the Department of Ecology (Ecology) made in drafting the proposed National Pollutant Discharge Elimination System (NPDES) permit for King County's West Point WWTP, CSO treatment plants, and associated CSO outfalls.

This fact sheet complies with Section 173-220-060 of the Washington Administrative Code (WAC), which requires Ecology to prepare a draft permit and accompanying fact sheet for public evaluation before issuing an NPDES permit.

Ecology makes the draft permit and fact sheet available for public review and comment at least thirty (30) days before issuing the final permit. Copies of the fact sheet and draft permit for King County's West Point WWTP and CSO system, NPDES permit WA0029181, were available for public review and comment from October 30, 2014 until November 29, 2014. For more details on preparing and filing comments about these documents, please see *Appendix A - Public Involvement Information*.

King County (County) reviewed the draft permit and fact sheet for factual accuracy. Based on this review, Ecology provided additional clarification and corrected any errors or omissions regarding the facility's location, history, or wastewater discharges prior to publishing this draft fact sheet for public notice. Significant comments from King County and Ecology's responses are listed in *Appendix I – Response to Comments*.

After the public comment period closes, Ecology will summarize substantive comments and provide responses to them. Ecology will include the summary and responses to comments in this fact sheet as *Appendix I - Response to Comments*, and publish it when issuing the final NPDES permit. Ecology will not revise the rest of the fact sheet, but the full document will become part of the legal history contained in the facility's permit file.

Summary

The proposed permit provides coverage for King County's West Point WWTP, four CSO treatment facilities (Alki, Carkeek, Elliott West, and Henderson/MLK), and 38 CSO outfalls.

The West Point WWTP treats domestic, commercial, and industrial wastewater and CSO stormwater from the greater Seattle area using a high rate oxygenated activated sludge biological treatment process with chlorine disinfection before discharging the treated effluent to central Puget Sound. For West Point WWTP, the proposed permit contains the same effluent limits for CBOD₅, total suspended solids, fecal coliform, pH, and total residual chlorine as the permit issued in 2009.

This permit proposes a few changes for the four CSO treatment plants. For all four facilities, compliance with settleable solids standards will be assessed annually instead of on an annual and per-event basis as in the previous permit. This is consistent with the legal basis in regulation (WAC 173-245). For the Alki and Carkeek CSO treatment facilities the proposed permit includes the same limits and monitoring requirements as the previous permit. For Elliott West and Henderson/MLK facilities, the following changes are being proposed:

Elliott West CSO treatment plant - Due to a change in mixing dilution, the limits for total residual chlorine increased slightly from a maximum daily average of 104 to 109 µg/L. Fecal coliform limits became more stringent as they changed from a monthly limit of 154 (with non-discharge days calculated in the monthly geometric mean as '1') to a guidance-based monthly limit of 400 counts/100 mL. Also, the proposed permit includes additional monitoring for dissolved oxygen, copper and cyanide, and requires a study to evaluate options for reducing copper and settleable solids concentrations.

Henderson/MLK CSO treatment plant – For this facility effluent limits remain the same. Copper monitoring is required for each event and PCB monitoring is required using EPA method 1668 with a method detection limit of 0.0001 µg/L.

Table of Contents

I. Introduction.....	7
II. Background Information	8
A. <i>Facility description.....</i>	<i>10</i>
History	10
Background	10
Collection system status	13
Treatment processes	16
Solid wastes/Residual solids	19
Discharge outfalls.....	20
B. <i>Description of the receiving water</i>	<i>26</i>
C. <i>Wastewater influent characterization.....</i>	<i>29</i>
D. <i>Wastewater effluent characterization.....</i>	<i>30</i>
E. <i>Sediment characterization.....</i>	<i>36</i>
F. <i>Summary of compliance with previous permit issued</i>	<i>46</i>
G. <i>State environmental policy act (SEPA) compliance</i>	<i>50</i>
III. Proposed Permit Limits	51
A. <i>Design criteria.....</i>	<i>51</i>
B. <i>Technology-based effluent limits.....</i>	<i>53</i>
C. <i>Surface water quality-based effluent limits</i>	<i>56</i>
Numerical criteria for the protection of aquatic life and recreation	56
Numerical criteria for the protection of human health	56
Narrative criteria	57
Antidegradation.....	57
Combined Sewer Overflows	58
Mixing zones	58
D. <i>Designated uses and surface water quality criteria</i>	<i>66</i>
Puget Sound Discharges:.....	66
Duwamish River Discharge (Henderson/MLK):.....	67
E. <i>Water quality and sediment impairments</i>	<i>68</i>
F. <i>Evaluation of surface water quality-based effluent limits for numeric criteria</i>	<i>69</i>
Estuarine Mixing Zones (West Point WWTP, Alki, Carkeek, and Elliott West).....	69
Freshwater Mixing Zone (Henderson/MLK)	70
Dilution Factors.....	70
G. <i>Human health</i>	<i>79</i>
H. <i>Sediment quality</i>	<i>79</i>
I. <i>Whole effluent toxicity</i>	<i>80</i>
J. <i>Groundwater quality limits.....</i>	<i>81</i>
K. <i>Comparison of effluent limits with the previous permit</i>	<i>81</i>
IV. Monitoring Requirements.....	83
A. <i>Wastewater monitoring</i>	<i>83</i>
B. <i>Lab accreditation.....</i>	<i>83</i>
V. Other Permit Conditions.....	84
A. <i>Reporting and record keeping</i>	<i>84</i>
B. <i>Prevention of facility overloading</i>	<i>84</i>
C. <i>Operation and maintenance</i>	<i>85</i>

D. Pretreatment	85
Duty to enforce discharge prohibitions	85
E. Solid wastes	86
F. Spill plan.....	86
G. Combined sewer overflows.....	86
CSO Reduction Plan/Long-Term Control Plan and CSO Reduction Plan Amendments.....	87
Nine Minimum Controls	87
CSO Monitoring	88
Annual CSO Report	88
Post-Construction Monitoring Program	88
H. Outfall evaluation.....	88
I. Elliott West CSO treatment plant – copper reduction assessment	88
J. Elliott West CSO treatment plant – settleable solids removal assessment.....	89
K. General conditions	89
VI. Permit Issuance Procedures.....	89
A. Permit modifications	89
B. Proposed permit issuance.....	89
VII. References for Text and Appendices.....	89
Appendix A — Public Involvement Information.....	92
Appendix B — Your Right to Appeal	93
Appendix C — Glossary	94
Appendix D — Receiving Water Data	101
Appendix E — Facility Data	102
Appendix F — Technical Calculations	127
Appendix G — Significant Industrial Users.....	163
Appendix H — Process Flow Diagrams.....	164
Appendix I — Response to Comments	168

List of Tables

Table 1. General Facility Information	8
Table 2. Summary of West Point WWTP’s Flow, BOD, and TSS Projections	11
Table 3. Future CSO Projects	15
Table 4. Combined Sewer Overflow Outfalls (38).....	24
Table 5. West Point Ambient Background Data ¹	26
Table 6. Alki Ambient Background Data ¹	27
Table 7. Carkeek Ambient Background Data ¹	27
Table 8. Elliott West Ambient Background Data	28
Table 9. Henderson/MLK Ambient Background Data ¹	29
Table 10. Influent Characterization - West Point WWTP	29
Table 11. Influent Characterization - Alki	29
Table 12. Influent Characterization - Carkeek.....	30
Table 13. Influent Characterization - Elliott West.....	30
Table 14. Influent Characterization - Henderson/MLK.....	30
Table 15. Effluent Characterization – West Point WWTP.....	31
Table 16. Effluent Characterization – Alki CSO TP	32
Table 17. Effluent Characterization – Carkeek CSO TP	33
Table 18. Effluent Characterization – Elliott West CSO TP	34
Table 19. Effluent Characterization – Henderson/MLK CSO TP	35
Table 20. West Point WWTP – Sediment Test Results.....	36
Table 21. Elliott West CSO treatment plant outfall – sediment remediation activity ⁷	39
Table 22. Henderson/MLK CSO treatment plant outfall – sediment remediation activity	40
Table 23. Untreated CSO outfalls – sediment remediation activity	42
Table 24. Sediment testing priorities for CSO outfalls & sampling results from 2011 & 2013....	43
Table 25. CSO outfalls scheduled to be controlled during this permit term.....	45
Table 26. Alki CSO Treatment Plant – Permit Violations.....	46
Table 27. Carkeek CSO Treatment Plant – Permit Violations	47
Table 28. Elliott West CSO Treatment Plant – Permit Violations and Permit Triggers	48
Table 29. Henderson/MLK CSO Treatment Plant – Permit Violations and Permit Triggers	50
Table 30. West Point WWTP Design Criteria	51
Table 31. Alki CSO Treatment Plant – Design Criteria	52
Table 32. Carkeek CSO Treatment Plant – Design Criteria	53
Table 33. EWCSO Treatment Plant – Design Criteria	53
Table 34. Henderson/MLK CSO Treatment Plant – Design Criteria	53
Table 35. Technology-based Limits (West Point WWTP).....	54
Table 36. Technology-based Mass Limits	54
Table 37. Technology & Guidance-based Limits for CSO Treatment Plants	55
Table 38. Metal Translators Used in Reasonable Potential Analyses	57
Table 39. West Point WWTP - Critical Conditions Used to Model the Discharge.....	60

Table 40. CSO discharge flows used in dilution calculations	60
Table 41. Alki CSO TP: Critical Conditions Used to Model the Discharge.	61
Table 42. Carkeek CSO TP: Critical Conditions Used to Model the Discharge.	61
Table 43. Elliott West CSO TP: Critical Conditions Used to Model the Discharge.	61
Table 44. Henderson/MLK CSO TP: Critical Conditions Used to Model the Discharge.	62
Table 45. Marine Aquatic Life Uses and Criteria - West Point WWTP, Alki, and Carkeek	67
Table 46. Marine Aquatic Life Uses and Associated Criteria - Elliott West.....	67
Table 47. Recreational Uses - West Point WWTP, Alki, Carkeek, and Elliott West.....	67
Table 48. Receiving Water Criteria Comparison for Henderson/MLK.....	68
Table 49. Comparison of Dilution Factors	71
Table 50. Comparison of Previous and Proposed Effluent Limits - West Point WWTP	81
Table 51. Comparison of Previous and Proposed Effluent Limits - Alki CSO TP	81
Table 52. Comparison of Previous and Proposed Effluent Limits - Carkeek CSO TP	82
Table 53. Comparison of Previous and Proposed Effluent Limits - Elliott West CSO TP	82
Table 54. Comparison of Previous and Proposed Effluent Limits – Henderson/MLK TP	82
Table 55. Lab Accredited Parameters	84

List of Figures

Figure 1. Facility Location.....	9
Figure 2. West Point WWTP outfall location.....	21
Figure 3. Alki CSO treatment plant outfall location.....	22
Figure 4. Carkeek CSO treatment plant outfall location.....	22
Figure 5. Elliott West CSO treatment plant outfall location.....	23
Figure 6. Henderson/MLK CSO treatment plant outfall location.....	24
Figure 7. Sediment sampling locations for West Pt WWTP outfall.....	37
Figure 8. Fecal Coliform data for Elliott West CSO TP.....	49
Figure 9. Residual chlorine data for Elliott West CSO TP.....	49
Figure 10. West Point’s WWTP’s Mixing Zone	64
Figure 11. Alki’s Mixing Zone	64
Figure 12. Carkeek’s Mixing Zone Zone.....	65
Figure 13. Elliott West Mixing Zone	65
Figure 14. Henderson/MLK Mixing Zones	66

I. Introduction

The Federal Clean Water Act (FCWA, 1972, and later amendments in 1977, 1981, and 1987) established water quality goals for the navigable (surface) waters of the United States. One mechanism for achieving the goals of the Clean Water Act is the National Pollutant Discharge Elimination System (NPDES), administered by the federal Environmental Protection Agency (EPA). The EPA authorized the state of Washington to manage the NPDES permit program in our state. Our state legislature accepted the delegation and assigned the power and duty for conducting NPDES permitting and enforcement to Ecology. The Legislature defined Ecology's authority and obligations for the wastewater discharge permit program in 90.48 RCW (Revised Code of Washington).

The following regulations apply to domestic wastewater NPDES permits:

- Procedures Ecology follows for issuing NPDES permits (chapter 173-220 WAC)
- Technical criteria for discharges from municipal wastewater treatment facilities (chapter 173-221 WAC)
- Water quality criteria for surface waters (chapter 173-201A WAC)
- Water quality criteria for groundwaters (chapter 173-200 WAC)
- Whole effluent toxicity testing and limits (chapter 173-205 WAC)
- Sediment management standards (chapter 173-204 WAC)
- Submission of plans and reports for construction of wastewater facilities (chapter 173-240 WAC)

The following additional regulations apply to communities operating collection systems with Combined Sewer Overflows (CSOs):

- Submission of plans and reports for construction and operation of CSO reduction facilities (chapter 173-245 WAC)
- US EPA CSO control policy (59 FR 18688)

These rules require any treatment facility owner/operator to obtain an NPDES permit before discharging wastewater to state waters. They also help define the basis for limits on each discharge and for requirements imposed by the permit.

Under the NPDES permit program and in response to a complete and accepted permit application, Ecology must prepare a draft permit and accompanying fact sheet, and make them available for public review before final issuance. Ecology must also publish an announcement (public notice) telling people where they can read the draft permit, and where to send their comments, during a period of thirty days (WAC 173-220-050, see *Appendix A-Public Involvement Information* for more detail about the public notice and comment procedures). After the public comment period ends, Ecology may make changes to the draft NPDES permit in response to comments. Ecology will summarize the responses to comments and any changes to the permit in *Appendix I*.

II. Background Information

Table 1. General Facility Information

Facility Information	
Applicant	King County Wastewater Treatment Division (WTD), Department of Natural Resources and Parks (DNRP)
Facility Names and Addresses	West Point Wastewater Treatment Plant (WWTP): 1400 Discovery Park Blvd, Seattle, WA 98199 Alki Storage and CSO Treatment Plant: 3380 Beach Drive SW, Seattle, WA 98116-2616 Carkeek Storage and CSO Treatment Plant: 1201 NW Carkeek Park Road, Seattle, WA 98177-4640 Denny/Elliott West Storage and CSO Treatment Plant: 545 Elliott Avenue West, Seattle, WA 98119 Henderson/MLK Storage and CSO Treatment Plant: 9829 42 nd Avenue South, Seattle, WA 98118
Responsible Official	Christie True Director, King County DNRP 201 S. Jackson Street, Seattle, WA 98104
Type of Treatment	West Point WWTP: Secondary (High-rate oxygenated activated sludge) Alki, Carkeek, Denny/Elliott West, and Henderson/MLK CSO Treatment Plants: Primary with Disinfection
Facility Location (NAD83/WGS84 reference datum)	West Point WWTP: Puget Sound Lat: 47.661465°, Long: -122.430693° Alki CSO Treatment Plant: Puget Sound Lat: 47.574605°, Long: -122.417348° Carkeek CSO Treatment Plant: Puget Sound Lat: 47.710869°, Long: -122.370723° Elliott West CSO Storage & Treatment Facility: Elliott Bay Lat: 47.624603°, Long: -122.366339° Henderson/MLK CSO Storage & Treatment Facility: Duwamish River Lat: 47.514003°, Long: -122.280776°
Discharge Waterbody Name and Location (NAD83/WGS84 reference datum)	West Point WWTP: Puget Sound Lat: 47.661111°, Long: -122.446389° Alki CSO Treatment Plant: Puget Sound Lat: 47.57025°, Long: -122.4225° Carkeek CSO Treatment Plant: Puget Sound Lat: 47.71264°, Long: -122.38789° Elliott West CSO Storage & Treatment Facility: Elliott Bay Lat: 47.61755°, Long: -122.36186° Henderson/MLK CSO Storage & Treatment Facility: Duwamish River Lat: 47.51194°, Long: -122.29736°

Permit Status	
Issuance Date of Previous Permit	June 22, 2009
Application for Permit Renewal Submittal Date	June 27, 2013
Date of Ecology Acceptance of Application	September 13, 2013

Inspection Status	
Date of Last Sampling Inspection	December 17-18, 2007
Date of Last Non-sampling Inspection Date	June 2, 2014

West Point Wastewater Treatment Plant and Combined Sewer Overflow System



Figure 1. Facility Location

A. Facility description

History

Metro (Municipality of Metropolitan Seattle) constructed the West Point Wastewater Treatment Plant (WWTP) in 1965 as a primary treatment plant. In 1972, the amended Federal Water Pollution Control Act (PL 92-500) established the National Pollutant Discharge Elimination System (NPDES) and pretreatment programs. Federal law provided that all sewage treatment plants were to meet secondary treatment requirements by July 1, 1977. During the period 1976-1977, Metro, the agency having ownership of the plant at the time, prepared a draft facility plan and Environmental Impact Statement (EIS) and submitted a request for federal funding through EPA Grant No C0530816-01 to meet secondary treatment requirements at West Point. In 1979, Metro applied to the USEPA for a Clean Water Act Section 301(h) Waiver from secondary treatment at West Point, Richmond Beach, and Carkeek. Metro also planned to apply for a waiver for the Alki treatment plant. Metro withdrew from the 301(h) waiver process on September 7, 1984, which resolved this process. On September 24, 1984, Ecology issued Metro an Administrative Order, Docket No. DE 84-577. The Order directed Metro to proceed with planning for secondary treatment at West Point and set a schedule for attaining secondary treatment no later than February 1, 1991. In November 1987, Ecology amended the Order by Consent Decree No. 87-2-05395-4 changing, among other things, the final compliance date to December 31, 1995. On January 1, 1994, King County assumed control of Metro's assets and obligations under the existing NPDES permits issued by the Ecology.

On December 8, 1995, Ecology certified that the West Point WWTP achieved the secondary treatment level.

Background

West Point WWTP

King County's Wastewater Treatment Division (WTD) owns and operates the West Point WWTP and associated regional facilities. Figure 1 shows the location of the West Point WWTP along with the four CSO treatment plants and 38 CSO outfalls that are also regulated by the proposed permit. The West Point WWTP is part of King County's regional system that collects and treats wastewater from homes, businesses, and industries surrounding the Lake Washington area. King County's other secondary wastewater treatment plants include South Plant (Renton), Brightwater (outside of Woodinville), Vashon, and Carnation.

King County provides wholesale wastewater treatment services to 17 cities, 16 local sewer utilities, and one Indian tribe. The county's WTD serves about 1.4 million people within a 420-square-mile service area, which includes most urban areas of King County and parts of south Snohomish County and northeast Pierce County. The local agencies own and operate independent collection systems, which include pipelines and pump stations to collect and convey wastewater flows in their service area to King County's regional system for treatment and disposal. The local agencies have long-term agreements with King County for this service. King County owns and operates the regional treatment plants, pipelines, pump stations, and other related facilities. The following is a list of the municipalities, sewer districts, and water districts that contribute wastewater to this facility: Bothell, Brier, Lake Forest Park, Redmond, Seattle, Woodway, Alderwood Water District, Highlands Sewer District, North Shore Utilities, NE Sammamish Sewer & Water District, Valley View,

Ronald Wastewater District, Sammamish Plateau Sewer & Water District, Skyway Water & Sewer District, and Olympic Water & Sewer District.

In addition to the domestic and commercial wastewater, nearly all of Seattle's industrial areas discharge to the West Point WWTP. 48 significant industrial users discharge industrial flows to the West Point system. Based on King County's permit application, West Point receives an estimated daily flow of 9.6 MGD from significant industrial sources.

Table 2 presents a summary of the flow, BOD, and TSS projections, as described in the County's NPDES permit application and waste load assessment analysis. The population projections take into account planned changes in apportionment of flows between the West Point, South Plant, and Brightwater WWTPs.

Table 2. Summary of West Point WWTP's Flow, BOD, and TSS Projections

Year	Res. Population + Employment	Percent Increase	Average Annual Flow (MGD)*	Influent BOD Loading (lb/day)	Influent TSS Loading (lb/day)
2014	1,251,888		95	140,000	157,900
2015	1,274,230	1.78%	96	142,500	160,400
2016	1,296,572	1.75%	97	145,000	162,800
2017	1,318,913	1.72%	98	147,500	165,300
2018	1,341,255	1.69%	99	150,000	167,800
2019	1,363,597	1.67%	100	152,500	169,800
<i>Design</i>	<i>1,251,888</i>		<i>215</i>	<i>254,000</i>	<i>274,000</i>

*Annual flow projections are based on average rainfall.

The West Point WWTP is located on the Puget Sound at the western tip of Discovery Park between Shilshole Bay and Elliott Bay. King County owns approximately 80 acres of land at the West Point site; twenty of these acres are considered subtidal. The current facilities occupy approximately 25 acres of land. The West Point WWTP serves mostly a combined sewer system area and therefore this NPDES permit contains additional permit requirements related specifically to combined sewer systems. Currently, the West Point WWTP provides secondary treatment for flows up to 300 MGD and provides primary treatment and disinfection for flows exceeding 300 MGD. The plant's hydraulic capacity is 440 MGD. The West Point WWTP is rated as a Class IV treatment plant, according to regulation.

In addition to the West Point WWTP, the proposed permit authorizes discharges from four CSO storage and treatment facilities (Alki, Carkeek, Elliott West, and Henderson/MLK) and 38 individual CSO outfalls.

Alki CSO Treatment Plant

Metro constructed the Alki treatment plant in 1958 as a primary treatment plant to serve the Alki Basin, an area of 4,095 acres. It is located in West Seattle at the intersection of Beach Drive and Benton Place on 2.8 acres. The service area is largely residential with a projected saturation population of 43,700. Commercial activity is concentrated along portions of California Avenue and SW Alaska Street. Metro overhauled the facility's mechanical and electrical systems in 1987 and added architectural enclosures. In 1998, the County remodeled the facility to operate as a near-fully automated CSO treatment plant, and added flow transfer components such as the West Seattle Pump Station and the West Seattle Tunnel. In 1999,

Ecology incorporated the Alki CSO treatment plant into the West Point WWTP NPDES Permit.

Hydraulic capacity at Alki CSO treatment plant is 45 to 65 MGD, depending on tide level. During dry-weather operation, the County sends all flows to the West Point WWTP for secondary treatment. During wet-weather operation, the Alki CSO treatment plant provides primary treatment, chlorine disinfection, and dechlorination to flows that exceed downstream collection system capacity. Downstream capacity is limited to 18.9 MGD of flow and 7.1 MG of storage in the Alki/West Seattle tunnel. To protect the Alki plant, the County discharges excess flows at the 63rd Avenue Pump Station outfall, a permitted CSO location.

According to the County's 2013 wasteload analysis report, the Alki basin is considered substantially built out. The county expects increased flows due to expected densification in the basin to be offset by a reduction in per capita water use due to conservation efforts. The County expects no net changes in base or average flows in the next 5 years.

The two pump stations upstream of the 63rd Pump Station (Murray & Barton) are undergoing construction upgrades. These projects will increase the storage upstream of the 63rd Pump Station, helping to reduce untreated combined sewer overflows. These projects will also tend to increase the volume treated at Alki. The County will review operational strategies at the 63rd PS, the inlet regulator gate, and the West Seattle Pump Station/Tunnel as these projects move forward.

Carkeek CSO Treatment Plant

Metro constructed the Carkeek treatment plant in 1962 as a primary treatment plant to serve the Carkeek Basin. It is located at 1201 NW Carkeek Park Road. In 1994, the County constructed a pumping station and converted the plant to a CSO treatment facility. The facility began operation as a CSO treatment facility on November 1, 1994, under its then-existing NPDES Carkeek permit. The current West Point permit contains permit limits for the Carkeek CSO treatment plant.

During dry-weather operation the facility operates as a pump station only and King County's West Section off-site crew services the facility three times a week. During wet-weather events, operators staff the plant during start up and shut down, as well as provide preventative maintenance and operational checks.

According to the County's 2013 wasteload analysis report, the Carkeek basin is considered substantially built out. The county expects increased flows due to expected densification in the basin to be offset by a reduction in per capita water use due to conservation efforts. The County expects no net changes in base or average flows in the next 5 years.

Elliot West CSO Treatment Facilities

Ecology modified the West Point NPDES Permit in 2005 to include the Elliott West CSO storage and treatment facility. The County constructed the Elliott West CSO treatment plant as part of the Denny Way/Lake Union CSO Control project. The Denny Way/Lake Union CSO Control project consists of several CSO facilities that store and treat CSOs from the County's Dexter and Denny Regulators, and the City of Seattle's CSOs around Lake Union. King County completed construction of the project in May 2005. The project consisted of four major elements: the East Portal, which captures flow from a number of sewer lines in the South Lake Union area; the 14-foot-diameter Mercer Street Storage and Treatment Tunnel; and the Elliott West CSO treatment facility located on Elliott Bay; and the transition and dechlorination facilities adjacent to the Denny Way regulator station. Two new CSO

outfalls were built in Elliott Bay—one outfall to replace the outfall structure at the Denny Way Regulator and another outfall for the Elliott West CSO treatment facility. The Mercer Tunnel provides storage for up to 7.2 MG and primary clarification for all flows entering the tunnel. The County designed the Elliott West treatment facility to provide final treatment (screening, disinfection, and dechlorination) to settled flows that exceed the capacity of the tunnel. After storm events, the tunnel and wet well are emptied by pumping these stored flows to West Point WWTP.

King County considers the Elliott West basin as already substantially developed. They expect to see continued significant redevelopment in the South Lake Union area over the next 5 years. Based on their 2013 wasteload analysis, the County estimates base flows and average wet weather flows will increase by about 5 to 7% over the next 5 years due to densification in the basin; these values are partially offset by a reduction in per capita water use due to water conservation efforts.

Henderson/MLK CSO Facilities

Ecology modified the West Point NPDES Permit in 2005 to include the Henderson/MLK CSO storage and treatment facility. The County implemented the Henderson/Norfolk CSO control project to control the Henderson and Martin Luther King (MLK) CSOs into Lake Washington and Norfolk CSOs into the Duwamish River. King County upgraded the Henderson/MLK Pump Station and constructed a large storage and treatment tunnel between Henderson Street and Norfolk Street in the Rainier Valley. The County designed the facilities to provide final treatment (screening, disinfection, and dechlorination) to settled flows that exceed the capacity of the storage and treatment tunnel, and to discharge treated flows through the Norfolk CSO outfall in the Duwamish Waterway. The County transfers base flows, settled solids, and stored flows from the tunnel to the South Plant at Renton or to the West Point WWTP, depending on capacity in the Elliot Bay Interceptor, for secondary treatment.

According to the County's 2013 wasteload analysis report, the Henderson/MLK basin is considered substantially built out. The county expects increased flows due to expected densification in the basin to be offset by a reduction in per capita water use due to conservation efforts. The City of Seattle is starting construction on their Henderson South CSO project that will increase conveyance and pumping capacity to the Henderson/MLK basin, resulting in increased volumes and peak flows. The City and the County signed an agreement on the South Henderson Projects in January 2014 to address any impacts of these new flows. Increased volumes are expected from the City's CSO basins 44, 45, 46, 47b/171, and 47c. Peak flow volume increases are expected from basins 46, 47b/171, and 47c. It is unknown at this time if flow changes are expected from basin 49 since that project is still under review. The County expects that the increased flows from the City will not result in violating the CSO control standard at the Henderson Pump station CSO outfall or the Henderson/MLK CSO storage and treatment facility. The County and City will monitor changes with flow monitoring and modeling.

Collection system status

The King County wastewater service area is divided into the East and West Sections. Wastewater from the East Section is conveyed to the South Treatment Plant; West Section wastewater flows to the West Point WWTP. The West Section service area includes areas north and west of Lake Washington and the City of Seattle. Developments within the north Lake Washington area were constructed with separate sanitary and storm sewers. Within the

City of Seattle, approximately 42,000 acres or 75 percent of the total area is constructed with combined sewers. Sanitary and combined flows from Seattle are merged prior to arriving at the West Point WWTP.

West Point WWTP receives wastewater from the west division collection system, a series of pump and regulator stations and related trunks and interceptors. Sewage flows by gravity via two influent tunnels (Ft. Lawton 144" Diameter and the Old Ft. Lawton Tunnel 84" Diameter) and enters the WWTP site at the influent control structure. The County's supervisory control and data acquisition (SCADA) computer systems automatically monitor and control the flow through the west division collection system. The control system minimizes surges, maximizes flow to the plant, and maximizes use of collection system storage to limit combined sewer overflows.

Combined Sewer Overflows

King County has 38 combined sewer overflow outfalls which discharge untreated sewage and stormwater during periods of heavy precipitation, within the city of Seattle. The collection system, as configured in 1983, discharged nearly 2.3 billion gallons per year of untreated sewage and stormwater from a total of 431 overflow events. Since 1988, the Metro/County has completed a number of projects to reduce the volume and frequency of CSOs. Based on data from 2006-2012, King County's average annual untreated CSO volume has been approximately 811 million gallons per year.

Between 1995 and 2005, King County constructed the Elliott West and Henderson/MLK projects, in addition to other CSO projects, to reduce CSO overflows. The County also implemented a real-time, web-based notification system that the public can use to assess when CSOs are discharging. The website can be found at:

<http://www.kingcounty.gov/environment/wastewater/CSO/RealTime/SeattleOverview.aspx>.

The County's *2008 CSO Reduction Plan Update* identified priority projects at locations near beach areas. Consequently, King County began construction on four CSO control projects near beach areas in late 2013. These projects include CSO storage tanks in South Magnolia, North Beach, and at the Murray pump station, and neighborhood green stormwater infrastructure in the Barton neighborhood of West Seattle.

In 2012, the King County Council adopted the *2012 CSO Long Term Control Plan Amendment*, and in 2013 the County entered a CSO consent decree with Ecology, EPA, and the DOJ. Both the LTCP and CD include nine CSO control projects to reduce CSOs to no more than one untreated event per year on average at each CSO location by 2030. Table 3 outlines future CSO control projects as presented in the County's *2012 CSO Long Term Control Plan Amendment* and 2013 consent decree.

Table 3. Future CSO Projects

Project Name	Project Description	Project Completion	Water Body
Hanford #1 (DSN 031)	0.34 MG storage and new conveyance	2019	Duwamish River
Brandon Street / South Michigan Street (DSN 041/039)	66 MG peak-flow CSO treatment facility and new conveyance	2022	Duwamish River
Chelan Avenue (DSN 036)	3.85 MG storage tank	2023	Duwamish River
3 rd Avenue W (DSN 008)	Joint City-County 7.23 MG storage tank or County-only 4.18 MG storage tank	2023	West Ship Canal
West Michigan Street / Terminal 115 (DSN 042/038)	0.32 MG storage pipe	2025	Duwamish River
University/Montlake (DSN 015)	Joint City-County 5.23 MG storage tank or County-only 2.94 MG storage tank	2028	Lake Union/ East Ship Canal
Montlake (DSN 014)	Joint City-County 7.87 MG storage tank or County-only 6.6 MG storage tank	2028	West Ship Canal
Hanford #2/ Lander Street/ King Street/ Kingdome (DSN 032/030/028/029)	151 MG peak-flow CSO treatment facility	2030	Duwamish River
11 th Avenue NW	Increased conveyance providing 3,200 feet of 84-inch diameter pipe	2030	West Ship Canal

Inflow and Infiltration

King County created a Regional Infiltration and Inflow (I/I) Control Program in 1999 as part of the Regional Wastewater Services Plan (RWSP) to explore the feasibility of regional I/I control. The purpose of the program is to reduce the amount of peak wet weather flow entering the County's wastewater conveyance system when it is cost-effective to do so. Reduction of I/I in the system may prevent sanitary sewer overflows and decrease the costs of conveying and treating extraneous flows.

In response to the RWSP I/I Control Program policies, County staff, working in a consensus-based approach with the local sewer agencies, conducted a comprehensive 6-year, \$41 million, I/I control study. The study began in 2000 and culminated with the County Executive's recommendation for a regional I/I control program. The following work was completed as part of this study:

- Levels of I/I for each local agency tributary to the regional system were defined through extensive flow monitoring and modeling program (2001-2002).
- 10 pilot projects were selected and constructed in 12 local agency jurisdictions to demonstrate the effectiveness of collection system rehabilitation projects and to test various technologies and gain cost information (2003-2004).
- Final draft model standards, procedures, policies, and guidelines were developed (October 2004) for use by local agencies to reduce I/I in their systems.
- A thorough benefit-cost analysis was conducted to determine the cost-effectiveness of I/I reduction (November 2005).
- A long-term regional I/I control plan was developed; approved by the King County Council in May 2006.

- King County worked with the local sewer agencies to conduct an I/I reduction feasibility analysis and selected three initial I/I reduction project areas (2007-2009).
- The Skyway Water and Sewer District I/I reduction project (2010-2014).

The County is currently analyzing the effectiveness of the Skyway Initial I/I Reduction Project (“Demonstration Project”). The project set out to rehabilitate close to 350 side sewers on private property, aiming to reduce flows by at least 60%, or about 1 MGD, in a Skyway Water and Sewer District basin. This reduction prediction was based conservatively on the reduction achieved in a similar, adjacent pilot project completed in 2003/4, in which I/I peak flow was reduced by 88.5%. For the Skyway Project, a 60% flow reduction would eliminate the need for the downstream 0.27 MG Bryn Mawr Storage Project. Project results fell short of the goal, with peak flows reduced by only 19% in the project basin. There are many complex reasons for this lower than expected flow reduction, most of which are contributed to basin-specific characteristics and conditions encountered during construction. One unique challenge was the discovery of a previously unrecognized flow diversion that sent flows from an adjacent basin into the project basin, diluting flow reduction results when flow monitoring was conducted. Other challenges include the effects of sump pumps and foundation drains, groundwater entering unrehabilitated side sewers downslope in the basin, and a higher than anticipated number of sewers being left out of the project for replacement due to field conditions. While the full reduction target was not met, it is still estimated that the sizing or timing of the storage project were beneficially affected by the Skyway project. Continued flow monitoring and modeling will determine the ultimate storage requirements, at which point the resulting benefit of the I/I reduction can be determined. For more information see the full report on the County’s I/I Program website.

Treatment processes

West Point WWTP

The West Point WWTP is a 215-million-gallon per day (maximum month design flow) high rate oxygen activated sludge secondary plant. Metro designed the plant to provide secondary treatment of flows up to 300 MGD. The liquid treatment process includes screening, grit removal, primary clarification, biological treatment using high rate oxygenated activated sludge, secondary clarification, chlorine disinfection, and dechlorination. The disinfected effluent discharges to Puget Sound through a multi-port diffuser located about 3,600 feet offshore at a depth of about 240 feet below mean lower low water. For flows above 300 MGD and up to 440 MGD, the treatment process consists of screening, de-gritting, primary sedimentation in clarifiers, disinfection with sodium hypochlorite in a chlorine contact channel, and dechlorination. As for solids treatment, the primary and waste activated solids are blended in a tank and co-thickened via gravity belt thickeners. The thickened sludge is anaerobically digested, and dewatered by centrifuges. The plant produces several products including biosolids used in agriculture and forestry, reclaimed water used for in-plant processes and irrigation, and methane that fuels the raw sewage pump engines and power generation system. A schematic of the treatment process is presented in Appendix H.

King County indicated in their permit application that 29 non-categorical significant industrial users (SIUs) and 19 categorical SIUs contribute to the collection system. These numbers are down from five years ago when King County reported 33 non-categorical SIUs and 31 categorical SIUs. See Appendix G for a listing of the significant users.

The West Point WWTP is rated as a Class IV plant. The West Section employs personnel in operations, maintenance, facilities, process control, laboratory analysis, administration, and off-site operations and maintenance. The section consists of approximately 156 FTEs with 10 to 15 vacancies at any given time. Operations staff consists of about 70 employees, where 21 employees have Group IV certifications, 21 have Group III certifications, 13 have Group II certifications, and 11 have Group I certifications.

Wet Weather Operation - The proposed permit authorizes CSO-related bypasses of the secondary treatment portion of the West Point WWTP when the instantaneous flows to the WWTP exceed 300 MGD as a result of precipitation. The wastewater that bypasses secondary treatment must receive floatables removal, primary clarification, and disinfection, and must at all times meet the effluent limits listed in S1. See Section III.A of this fact sheet for more information on wet weather authorization.

Alki CSO Treatment Plant

The Alki CSO treatment plant operates only when flows in the Alki service area exceed 18.9 MGD or when the storage in the tunnel has been filled. The County diverts the base flow to the West Seattle Pump Station, then directly to the West Point WWTP for secondary treatment. The County diverts wet weather flows in excess of 18.9 MGD or 7.1 million gallons of storage (West Seattle Tunnel) to the Alki CSO treatment plant for treatment. Treatment consists of disinfection using sodium hypochlorite, screening, and primary sedimentation followed by dechlorination with sodium bisulfite. Treated flows discharge to the Puget Sound through the existing outfall.

Flows in excess of the Alki CSO treatment plant capacity discharge through the 63rd Avenue pump station outfall, which is a permitted CSO located upstream of the treatment plant. King County is already meeting the Ecology standard of no more than one untreated overflow per year at this location.

Treatment plant solids and grit are conveyed to the Alki Trunk for transfer to the West Seattle Tunnel and further conveyance to West Point WWTP. Screenings are collected, stored on-site, and disposed of as solid waste.

Carkeek CSO Treatment Plant

During dry weather and normal flows, the facility operates as a pump station only, pumping wastewater to the West Point WWTP. The Carkeek CSO treatment plant operates only during storm events when the combined sanitary/stormwater flows exceed the Carkeek Pump Station capacity (9.2 MGD), or when the downstream interceptor is full. The plant stores excess flows, solids, and grit, and then automatically returns them to the pump station wet well when there is capacity available at the pump station, or at the end of the storm. The pump station then pumps flow to the West Point WWTP.

If flows exceed the storage capacity of the treatment tanks, treated flows discharge to Puget Sound through a 4,200-foot long outfall. After the storm event, or when there is capacity available at the pump station, any wastewater in the plant is pumped to the West Point WWTP.

The treatment process consists of bar screens, a grit chamber, primary sedimentation, disinfection with sodium hypochlorite, and dechlorination with sodium bisulfite. When pumping capacity is exceeded wastewater spills over the pump wet well weir into the vault where hypochlorite is added to control odors and provide disinfection. From the vault wastewater flows into the grit tank that is equipped with aerators; settled grit is pumped to the solids storage tanks. From the grit tanks, the wastewater flows into two primary sedimentation

tanks. Solids settled in the primary sedimentation tanks are also pumped to the solids storage tanks. When both sedimentation tanks are full, wastewater flows into the contact tank for dechlorination, and from there over a weir to the outfall in Puget Sound.

Elliott West CSO Storage and Treatment Facility

The Elliott West CSO storage and treatment facility and associated conveyance facilities work to reduce CSOs to south, east, and west Lake Union and to Elliott Bay at the Denny Way Regulator Station. King County operates the facility in five modes depending on the magnitude of the rain event. The operating modes are as follows¹:

Standby Mode (Dry Weather Operation) - Under dry weather conditions, the facility does not divert flow. Wastewater continues to flow through the Lake Union Tunnel and other conveyance facilities to the Elliott Bay Interceptor (EBI) to be treated at the West Point WWTP. The Mercer Tunnel is empty so that the storage capacity is maintained for storm events.

Tunnel Storage Mode - During storm conditions, when water levels rise to established levels in the Lake Union Tunnel Regulator, Central Trunk Diversion Structure, and/or Denny Way Diversion Structure, the County diverts flow from these structures to the Mercer Street Tunnel for storage. After the storm, or whenever the EBI has capacity, stored wastewater is pumped to West Point. Wastewater that previously discharged into Elliott Bay or Lake Union CSOs now is captured in the Mercer tunnel.

CSO Pumping and Treatment Mode - When tunnel storage and the EBI reach capacity, Elliott West treatment begins. Flow is pumped from the downstream end of the Mercer Tunnel into the floatable-control channel. The wastewater flows through mechanical screens to remove floatable materials, then into the effluent channel for injection with sodium hypochlorite for disinfection. Prior to discharge into Elliott Bay, the treated wastewater is treated with sodium bisulfite to neutralize residual chlorine. Throughout this pump and treatment mode, the County pumps solids from the base of tunnel to the EBI, reducing the discharge of solids to the Puget Sound.

Pumping and Treatment Extreme Event Mode – The County designed the CSO treatment plant with a capacity of 250 MGD, for the one-event-per-year storm. When flows exceed 250 MGD untreated wastewater discharges from the Denny Way Regulator Station via the extended Denny Way CSO outfall. Flows entering the Mercer Street Tunnel in excess of 250 MGD can overflow with no floatables control or disinfection. Meanwhile, 250 MGD of treated effluent continues to discharge through the Elliott West outfall.

Dewatering Mode (Tunnel Drawdown) - Following a CSO event, when capacity is available in the EBI, wastewater stored in the tunnel is pumped to the EBI and conveyed to the West Point WWTP for secondary treatment. Solids that settled in the tunnel during the event are also flushed to West Point WWTP.

Henderson/MLK CSO Treatment and Storage Facility

King County's East Section operates and maintains the Henderson/MLK CSO storage and treatment facility. The facility reduces CSO discharges to Lake Washington and the Duwamish River. The Henderson/MLK tunnel is 14'8" in diameter and 3100 feet long and holds 3.5 million gallons of combined wastewater. The different operating modes for the facility depend on the rain event magnitude as follows:

¹ King County and City of Seattle, *Denny Way/Lake Union CSO Control Facilities Plan*, July 1998.

Inlet Regulator Operation - The Henderson/MLK tunnel inlet regulator accepts flows from the Henderson pump station and the Empire Way Trunk. Under typical, non-storm-event flow conditions wastewater flows through the Henderson tunnel inlet regulator, to the Henderson Street Trunk on Martin Luther King Way, to the Henderson Diversion structure, and then on to South Plant for treatment. When the conveyance line reaches capacity, the MLK regulator gate closes, filling the regulator station until combined sewage flows over a weir into the Henderson/MLK tunnel.

Storage Mode - The tunnel stores combined sewage during peak flow events, and as long as the tunnel capacity is not exceeded, the combined sewage is returned to the collection system for additional treatment at a WWTP. Hypochlorite is injected automatically upon flow overtopping the tunnel's inlet weir. The hypochlorite feed rate is controlled automatically based on the quantity of combined sewage entering the tunnel. After a filling event, when the trunk line returns to a specified level, the modulating drain valve opens and slowly drains the tunnel. The tunnel is drained such that the stored flows can be diverted at the Henderson Diversion Structure to either South Plant or West Point. After draining, the County has the ability to flush settled solids from the tunnel into the Henderson Trunk to convey them to a WWTP for treatment.

Treated CSO - In the event that the tunnel reaches capacity and wastewater continues to flow into the tunnel, the combined sewage flows over the discharge weir and discharges by gravity through two bar screens, where it is dechlorinated, then flows to the Norfolk outfall (044) on the Duwamish River at river km 10.5. After the storm event, combined sewage remaining in the tunnel is drained into the Henderson Trunk and conveyed to a WWTP for treatment.

Solid wastes/Residual solids

West Point WWTP

The treatment facilities remove solids during the treatment of the wastewater at the headworks (grit, screenings, debris, rags), and at the primary and secondary clarifiers, in addition to incidental solids (rags and other debris) removed as part of the routine maintenance of the equipment. The plant generates approximately 3,500 tons of grit annually. Grit, rags, and screenings are drained and recycled or disposed of as solid waste. The County installed new influent screens with 3/8 inch openings in 2014. As a result of these new screens, the capture of screenings, rags, and debris is expected to increase.

Primary sludge and waste-activated sludge are blended together and thickened by gravity belt thickeners. The thickened sludge is then pumped to one-of-six anaerobic, mesophilic digesters. From the digesters, the digested sludge is withdrawn and dewatered by one-of-four centrifuges. Polymers are used in the gravity belt thickeners and centrifuges to aid sludge thickening/dewatering. The digestion process produces nutrient-rich, organic byproducts called biosolids.

According to the County's 2012 *Biosolids Quality Report*, biosolids contain water, sand, organic matter, microorganisms, trace metals, and other chemicals. The report states, "because of their moisture content, humus-like characteristics, essential nutrients for plants, and very low levels of pollutants, biosolids are beneficial and safe to use as a soil conditioner, fertilizer for forest trees and agricultural crops, and as an ingredient of composts for landscaping."

King County Wastewater Treatment Division began recycling biosolids on land in 1973. The program has grown to beneficially recycle more than 110,000 wet tons (or approximately 27,000 dry tons) annually in forestry, agriculture, soil reclamation and compost.

Biosolids are regulated under both state and federal regulations (WAC 173-308 and 40 CFR Part 503). King County routinely monitors its biosolids for physical, chemical, and microbial characteristics, to examine changes over time, and to determine appropriate application rates for biosolids at reuse sites. The County's West Point biosolids continue to meet quality standards for metals, pathogen reduction (Class B), and vector attraction reduction, which means it is safe for all land application projects.

The 2012 data report indicates that King County's biosolids quality is excellent when compared with all relevant criteria. Concentrations of regulated metals in biosolids were consistently below the most stringent state and federal standards for land application. While not required by federal or state biosolids regulations, King County analyzes its biosolids for 135 trace organic compounds listed on the EPA Priority Pollutant List (40 CFR 423, Appendix A) and the Hazardous Substances List (40 CFR 116.4 A & B). Less than 15 percent of these compounds were detected in biosolids during 2007. The County detected twenty priority pollutants at very low concentrations in the West Point biosolids. These compounds included polynuclear aromatic hydrocarbons (PAHs), phthalates, polychlorinated biphenyls (PCBs), and solvents.

CSO Treatment Plants

For the Alki and Carkeek CSO facilities, grit and primary sludge settle in the storage tanks. After the storm subsides, the storage tank contents, solids and liquids, are pumped to the West Point WWTP for treatment.

For the Elliott West and Henderson/MLK facilities, solids settle in the storage tunnels. Following each storm event, solids in the Mercer Tunnel are automatically flushed and pumped to the West Point WWTP and solids in the Henderson/MLK Tunnel are flushed and pumped to the South Plant or West Point WWTP for treatment.

Discharge outfalls

West Point WWTP Outfall

The plant discharges treated effluent to the Puget Sound via an eight-foot diameter, reinforced concrete pipe. The diffuser section consists of 600 feet of pipeline with 200 ports that run on the north and south sides of the pipe. The 4.5- to 5.75-inch diameter ports are located about one foot above the spring line. The diffuser terminates about 3,600 feet offshore at a depth of approximately 230 feet below mean lower low water.

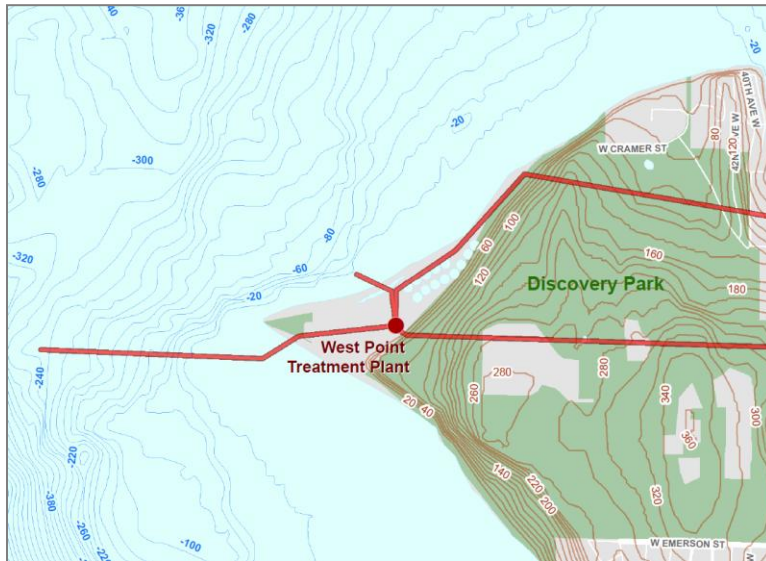

Figure 2. West Point WWTP outfall location

A 2004 outfall inspection revealed that all external components of the outfall appeared to be in good condition with no physical damage or lack of flow coming from the diffusers. The inspectors found minimal marine growth along the outfall alignment with slightly more located in the diffuser area.

King County inspected the West Point outfall and diffuser again on September 14, 2011, and provided Ecology with a report with video. The inspectors observed that the outfall line was completely buried from a rock pile at 196 feet of water to the shoreline. The inspectors found gaps in the pipeline around station 30 but they noted that no effluent appeared to be discharging from these gaps. Overall they found the outfall pipe in good condition with heavy sea anemone growth along the deeper sections. No remedial actions were recommended. The proposed permit requires another inspection during the permit term.

Alki CSO Treatment Plant Outfall

The Alki CSO treatment plant discharges primary treated and disinfected CSO effluent to the Puget Sound via a 42-inch diameter pipe, which extends approximately 2,000 feet offshore and terminates at a depth of approximately 143 feet below mean lower low water. The diffuser is fitted with eight 12 inch diameter risers/ports, with rubber check valves, spaced 20 feet apart in alternating directions. The two end ports discharge at an angle of 135° with respect to the other risers/ports. Engineers rated the outfall capacity at 45 MGD at mean higher high water and 65 MGD at mean lower low water. Flows in excess of these values discharge via the 63rd Avenue Pump Station outfall, a permitted CSO location.



Figure 3. Alki CSO treatment plant outfall location

Carkeek CSO Treatment Plant Outfall

The Carkeek CSO treatment plant discharges primary treated and disinfected CSO effluent to the Puget Sound via a 33-inch diameter 4,200-foot outfall, which extends approximately 2,200 feet offshore and terminates at a depth of 195 feet below mean lower low water. The outfall consists of a 50 foot diffuser with 13 ports.



Figure 4. Carkeek CSO treatment plant outfall location

Elliott West CSO Storage and Treatment Outfall

The Elliott West CSO treatment plant discharges primary treated and disinfected CSO effluent to Elliott Bay via a 96-inch diameter outfall, which extends 400 feet offshore and terminates at a depth of 60 feet below mean lower low water.

During large storm events when the Mercer tunnel and Elliott West facility capacities are exceeded, the Denny Regulator Station discharges untreated CSO water to Elliott Bay via the Denny CSO outfall. The 120-inch Denny CSO outfall extends 100 feet offshore and terminates at a depth of 20 feet below mean lower low water.



Figure 5. Elliott West CSO treatment plant outfall location

Henderson/MLK CSO Treatment and Storage Outfall

The Henderson/MLK CSO facility discharges primary treated and disinfected CSO effluent to the Duwamish River through the existing Norfolk outfall. The Norfolk outfall is located on the north bank of the Duwamish River at approximately river km 10.5. The 84-inch diameter outfall approaches the river bank at a 90-degree angle to the river flow and is flush with the bank. The outfall terminates with a flap gate that is assumed to be completely open during discharge events.²

Combined Sewer Overflow Outfalls

Table 4 lists King County's 38 combined sewer overflows outfalls (not including the CSO treatment plant outfalls), which have the potential to discharge untreated sewage and stormwater during precipitation events. Based on monitoring data in King County's *2012 Annual CSO Report* and King County's *2012 Long Term Control Plan Amendment*, 16 of the 38 CSO outfalls meet the controlled performance standard of "greatest reasonable reduction" as defined in chapter WAC 173-245-020(22). Table 4 provides project status for the uncontrolled outfalls as described in King County's *2012 Long Term Control Plan Amendment*.

² King County, Department of Natural Resources, Wastewater Treatment Division, *Henderson/M.L. King CSO Control Facilities Plan*, February 2002. Chapter 22, pg. 2.

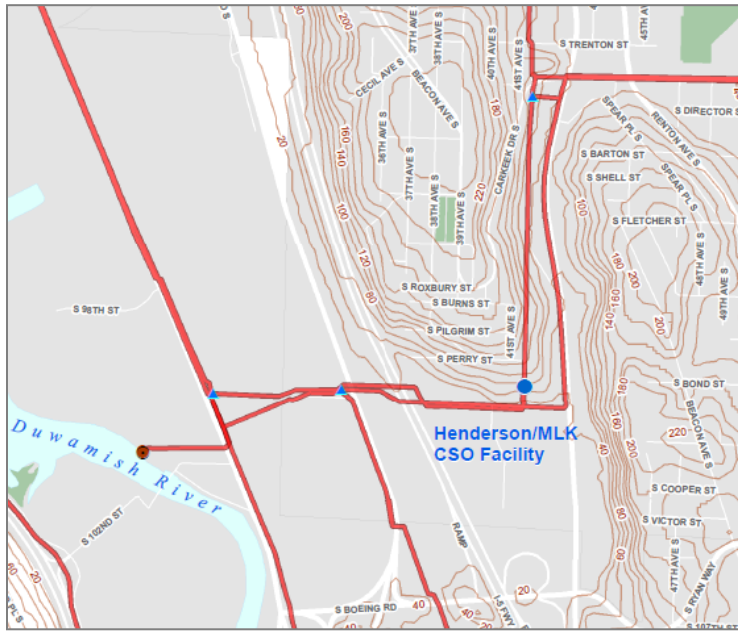

Figure 6. Henderson/MLK CSO treatment plant outfall location

Table 4. Combined Sewer Overflow Outfalls (38)

Outfall No.	Outfall Name	Receiving Water	Control Status	Project Status
003	Ballard Siphon Regulator	Lake Washington Ship Canal	Uncontrolled	Control project completed in December 2013.
004	11 th Avenue NW (East Ballard Overflow)	Lake Washington Ship Canal	Uncontrolled	Overflow reduction project underway.
006	Magnolia South Overflow	Elliott Bay/Puget Sound	Uncontrolled	Control project underway.
007	Canal Street Overflow	Lake Washington Ship Canal	Controlled	
008	3 rd Avenue West Overflow	Lake Washington Ship Canal	Uncontrolled	Control project in KC's Recommended CSO Control Plan.
009	Dexter Avenue Regulator	Lake Union	Uncontrolled	Control project completed. Full control being achieved by operational adjustments and upstream GSI.
011	E. Pine Street PS Emergency Overflow	Lake Washington	Controlled	
012	Belvoir PS Emergency Overflow	Lake Washington (Union Bay)	Controlled	
013	Martin Luther King Way Trunkline Overflow	Lake Washington	Controlled	
014	Montlake Overflow	Lake Washington Ship Canal	Uncontrolled	Control project in KC's Recommended CSO Control Plan.
015	University Regulator	Lake Wash Ship Canal (Portage Bay)	Uncontrolled	Overflow reduction project completed in 1994. Control project in KC's Recommended CSO Control Plan.
018	Matthews Park PS Emergency Overflow	Lake Washington	Controlled	
027a	Denny Way Regulator	Elliott Bay/Puget Sound	Uncontrolled	Control project completed. Full control being achieved by operational adjustment and facility mods.

Table 4. Combined Sewer Overflow Outfalls (38)

Outfall No.	Outfall Name	Receiving Water	Control Status	Project Status
028	King Street Regulator	Elliott Bay/Puget Sound	Uncontrolled	Control project in KC's Recommended CSO Control Plan.
029	Kingdome (Connecticut St Regulator)	Elliott Bay/Puget Sound	Uncontrolled	Installation of a storage pipeline in 1994. Partial separation in 1999. Control project in KC's Recommended CSO Control Plan.
030	Lander Street Regulator	Duwamish River – East Waterway	Uncontrolled	Control project in KC's Recommended CSO Control Plan.
031a,b,c	Hanford #1 Regulator	Duwamish River – East Waterway	Uncontrolled	Overflow reduction project completed in 1992. Final control project included in KC's Recommended CSO Control Plan.
032	Hanford #2 Regulator	Duwamish River – East Waterway	Uncontrolled	Control project in KC's Recommended CSO Control Plan.
033	Rainier Avenue PS Emergency Overflow	Lake Washington	Controlled	
034	E. Duwamish Siphon/Duwamish PS Emergency Overflow	Duwamish River	Controlled	
035	W. Duwamish Siphon/Duwamish PS Emergency Overflow	Duwamish River	Controlled	
036	Chelan Avenue Regulator	Duwamish River – West Waterway	Uncontrolled	Control project in KC's Recommended CSO Control Plan.
037	Harbor Avenue Regulator	Duwamish River – West Waterway	Uncontrolled	Control project completed. CSO site appears controlled – Modeling confirmation underway.
038	Terminal 115 Overflow	Duwamish River	Uncontrolled	Control project in KC's Recommended CSO Control Plan.
039	Michigan S. Regulator	Duwamish River	Uncontrolled	Control project in KC's Recommended CSO Control Plan.
040	8 th Avenue South Regulator (West Marginal Way PS Emergency Overflow)	Duwamish River	Controlled	
041	Brandon Street Regulator	Duwamish River	Uncontrolled	Overflow reduction project completed in 2003. Final control project included in KC's Recommended CSO Control Plan.
042	Michigan W. Regulator	Duwamish River	Uncontrolled	Control project in KC's Recommended CSO Control Plan.
043	East Marginal Way PS Emergency Overflow	Duwamish River	Controlled	
044a	Norfolk Street Regulator	Duwamish River	Controlled	
045	Henderson Street Pump Station Emergency Overflow	Lake Washington	Controlled	
048	North Beach PS Emergency Overflow	Puget Sound	Uncontrolled	Control project underway
049	30 th Avenue N.E. PS Emergency Overflow	L. Wash. Ship Canal (Union Bay)	Controlled	
053	53 rd St SW PS Emerg. Overflow	Puget Sound	Controlled	
054	63 rd St SW PS Emerg. Overflow	Puget Sound	Controlled	
055	S.W. Alaska Street Overflow	Puget Sound	Controlled	
056	Murray St PS Emerg. Overflow	Puget Sound	Uncontrolled	Control project underway
057	Barton St PS Emerg. Overflow	Puget Sound	Uncontrolled	Control project underway

B. Description of the receiving water

King County submitted ambient background data with their permit application in a report called *Receiving Water Characterization Study* (June 2013). This report presented results of a characterization study of ambient receiving water in central Puget Sound, Elliott Bay, and the Duwamish River.

West Point WWTP

The West Point WWTP outfall discharges to central Puget Sound. Other nearby point source outfalls include King County's South Plant outfall and Bainbridge Island's WWTP outfall. Significant nearby non-point sources of pollutants include stormwater runoff, industrial runoff, and maritime uses. Water quality impairments for this waterbody are discussed in Section III.E of this fact sheet.

Ecology used ambient data from sampling station KSBP01 in King County's receiving water study to assess compliance with water quality standards. This sampling station is located six miles north of the West Point outfall (47.743960°, -121.428169°).

Table 5. West Point Ambient Background Data¹

Parameter	Value
Temperature (highest annual 1-DADMax)	14.0° C (at 1.3 m below surface)
pH (Minimum / Maximum)	7.5 / 8.0 std units
Salinity (minimum)	26.1 pss
Dissolved Oxygen (10 th percentile)	6.1 mg/L
Total Ammonia (max)	0.085 mg/L as N (from LSNT01)
Fecal Coliform (max)	4 / 100 mL
TSS (max)	7 mg/L
Arsenic (90th percentile), Dissolved / Total ²	1.390 / 1.360 µg/L
Cadmium (90th percentile), Dissolved / Total	0.073 / 0.081 µg/L
Chromium (90th percentile), Dissolved / Total	0.148 / 0.159 µg/L
Copper (90th percentile), Dissolved / Total	0.363 / 0.410 µg/L
Lead (90th percentile), Dissolved / Total	0.005 / 0.044 µg/L
Mercury (90th percentile), Dissolved / Total	0.00020 / 0.00048 µg/L
Nickel (90th percentile), Dissolved / Total	0.424 / 0.437 µg/L
Silver (90th percentile), Dissolved / Total	0.027 / 0.028 µg/L
Zinc (90th percentile), Dissolved / Total	0.643 / 0.685 µg/L

¹ Data source: *King County Receiving Water Characterization Study - Final Report*, June 2013.

² Data reported in 2013 report shows 90th percentile of dissolved fraction as slightly larger than total concentration. This discrepancy is likely within the precision of the analytical method.

Alki CSO Treatment Plant

The Alki CSO treatment plant discharges to the Puget Sound. Another nearby point source outfall includes King County's South Plant outfall. Significant nearby non-point sources of pollutants include stormwater runoff.

Ecology used ambient data from sampling station LSNT01 in King County's receiving water study to assess compliance with water quality standards. This sampling station is located three miles south of the Alki outfall (47.533333°, -121.433333°).

Table 6. Alki Ambient Background Data¹

Parameter	Value
Temperature (highest annual 1-DADMax)	12.7° C (at 1.3 m below surface)
pH (Minimum / Maximum)	7.4 / 8.0 std units
Salinity (minimum)	27.7 pss
Alkalinity (10 th percentile)	97.5 mg/L CaCO ₃
Dissolved Oxygen (10 th percentile)	5.8 mg/L
Total Ammonia (max)	0.085 mg/L as N
Fecal Coliform (max)	1 / 100 mL
TSS (max)	7.5 mg/L
Antimony (90th percentile), Dissolved / Total	0.172 / 0.178 µg/L
Arsenic (90th percentile), Dissolved / Total	1.450 / 1.450 µg/L
Cadmium (90th percentile), Dissolved / Total	0.073 / 0.081 µg/L
Chromium (90th percentile), Dissolved / Total ²	0.150 / 0.145 µg/L
Copper (90th percentile), Dissolved / Total	0.354 / 0.428 µg/L
Lead (90th percentile), Dissolved / Total	0.006 / 0.045 µg/L
Mercury (90th percentile), Dissolved / Total	0.00020 / 0.00038 µg/L
Nickel (90th percentile), Dissolved / Total	0.427 / 0.476 µg/L
Silver (90th percentile), Dissolved / Total	0.026 / 0.029 µg/L
Zinc (90th percentile), Dissolved / Total ²	0.605 / 0.538 µg/L

¹ Data source: *King County Receiving Water Characterization Study - Final Report*, June 2013.

² Data reported in 2013 report shows 90th percentile of dissolved fraction as slightly larger than total concentration. This discrepancy is likely within the precision of the analytical method.

Carkeek CSO Treatment Plant

The Carkeek CSO treatment plant discharges to Puget Sound. Pipers Creek also discharges to Puget Sound and affects water quality in this area. Significant nearby non-point sources of pollutants include stormwater runoff.

Ecology used ambient data from sampling station KSBP01 in King County's receiving water study to assess compliance with water quality standards. This sampling station is located two miles northwest of the Carkeek outfall (47.743960°, -121.428169°).

Table 7. Carkeek Ambient Background Data¹

Parameter	Value
Temperature (highest annual 1-DADMax)	14.0° C (at 1.3 m below surface)
pH (Minimum / Maximum)	7.5 / 8.0 std units
Salinity (minimum)	26.1 pss
Dissolved Oxygen (10 th percentile)	6.1 mg/L
Total Ammonia (max)	0.085 mg/L as N
Fecal Coliform (max)	4 / 100 mL
TSS (max)	7 mg/L
Arsenic (90th percentile), Dissolved / Total ²	1.390 / 1.360 µg/L
Cadmium (90th percentile), Dissolved / Total	0.073 / 0.081 µg/L
Chromium (90th percentile), Dissolved / Total	0.148 / 0.159 µg/L
Copper (90th percentile), Dissolved / Total	0.363 / 0.410 µg/L
Lead (90th percentile), Dissolved / Total	0.005 / 0.044 µg/L
Mercury (90th percentile), Dissolved / Total	0.00020 / 0.00048 µg/L
Nickel (90th percentile), Dissolved / Total	0.424 / 0.437 µg/L
Silver (90th percentile), Dissolved / Total	0.027 / 0.028 µg/L
Zinc (90th percentile), Dissolved / Total	0.643 / 0.685 µg/L

¹ Data source: *King County Receiving Water Characterization Study - Final Report*, June 2013.

² Data reported in 2013 report shows 90th percentile of dissolved fraction as slightly larger than total concentration. This discrepancy is likely within the precision of the analytical method.

Elliott West CSO Treatment Plant

The Elliott West CSO treatment plant outfall discharges to Elliott Bay. Significant nearby non-point sources of pollutants include stormwater runoff and maritime uses.

Ecology used ambient data from sampling station LTED04 in King County's receiving water study to assess compliance with water quality standards. This sampling station is located one mile west of the Elliott West outfall (47.603642°, -121.356514°).

Table 8. Elliott West Ambient Background Data

Parameter	Value
Temperature (highest annual 1-DADMax)	13.4° C (at 1 m below surface)
pH (Minimum / Maximum)	7.4 / 8.0 std units
Salinity (minimum)	24.0 pss
Dissolved Oxygen (10 th percentile)	5.7 mg/L
Total Ammonia (max)	0.085 mg/L as N (from LSNT01)
Fecal Coliform (geometric mean)	2 / 100 mL
TSS (max)	8.1 mg/L
Arsenic (90th percentile), Dissolved / Total	1.388 / 1.407 µg/L
Cadmium (90th percentile), Dissolved / Total	0.072 / 0.079 µg/L
Chromium (90th percentile), Dissolved / Total	0.139 / 0.167 µg/L
Copper (90th percentile), Dissolved / Total	0.487 / 0.696 µg/L
Lead (90th percentile), Dissolved / Total	0.005 / 0.066 µg/L
Mercury (90th percentile), Dissolved / Total	0.00020 / 0.00039 µg/L
Nickel (90th percentile), Dissolved / Total	0.432 / 0.464 µg/L
Silver (90th percentile), Dissolved / Total	0.028 / 0.032 µg/L
Zinc (90th percentile), Dissolved / Total	0.995 / 0.903 µg/L

Data source: *King County Receiving Water Characterization Study - Final Report*, June 2013.

Henderson/MLK CSO Treatment Plant

The Henderson/MLK CSO treatment plant outfall discharges to the Duwamish waterway. This discharge shares an outfall with Seattle's Norfolk stormwater outfall. Another significant nearby source of pollutants is Boeing's industrial stormwater outfall.

Ecology used ambient data from sampling station LTXQ01 in King County's receiving water study to assess compliance with water quality standards. This sampling station is located approximately 600 feet downstream of the Henderson/MLK outfall (47.512269°, -121.29970°).

Table 9. Henderson/MLK Ambient Background Data ¹

Parameter	Value
Temperature (highest annual 1-DADMax)	18.7° C (at 1 m below surface)
pH (Minimum / Maximum)	6.8 / 7.3 std units
Salinity (minimum, ½ of DL)	1.0 pss
Dissolved Oxygen (10 th percentile)	7.5 mg/L
Fecal Coliform (max, minus outlier)	110 / 100 mL
TSS (90 th percentile)	20 mg/L
Arsenic (90th percentile), Dissolved / Total	0.555 / 0.796 µg/L
Cadmium (90th percentile), Dissolved / Total ²	0.020 / 0.018 µg/L
Chromium (90th percentile), Dissolved / Total	0.084 / 0.215 µg/L
Copper (90th percentile), Dissolved / Total	0.551 / 1.195 µg/L
Lead (90th percentile), Dissolved / Total	0.025 / 0.243 µg/L
Mercury (90th percentile), Dissolved / Total	0.00076 / 0.00175 µg/L
Nickel (90th percentile), Dissolved / Total ²	0.966 / 0.934 µg/L
Silver (90th percentile), Dissolved / Total	0.021 / 0.044 µg/L
Zinc (90th percentile), Dissolved / Total	1.135 / 1.810 µg/L

¹ Data source: *King County Receiving Water Characterization Study - Final Report*, June 2013.

² Data reported in 2013 report shows 90th percentile of dissolved fraction as slightly larger than total concentration. This discrepancy is likely within the precision of the analytical method.

C. Wastewater influent characterization

King County reports influent pollutant concentrations in discharge monitoring reports. The following tables summarize influent wastewater quality for each facility for the period between July 2009 and October 2013.

Table 10. Influent Characterization - West Point WWTP

Parameter	Units	# of Samples	Average Monthly Average	Maximum Monthly Average
BOD ₅	mg/L	≈260	193	270
	lbs/day	≈260	137,112	168,700
CBOD ₅	mg/L	≈1800	165	227
	lbs/day	≈1800	117,115	147,500
TSS	mg/L	≈1800	221	293
	lbs/day	≈1800	161,975	191,645

Table 11. Influent Characterization - Alki

Parameter	Units	# of Samples	Average	Maximum
Volume	MG	19	13.7	50.7
			Average Monthly Average	Maximum Monthly Average
BOD ₅	mg/L	≈20	36	93
TSS	mg/L	≈20	89	213

Table 12. Influent Characterization - Carkeek

Parameter	Units	# of Samples	Average	Maximum
Volume	MG	23	3.8	18.5
			Average Monthly Average	Maximum Monthly Average
BOD ₅	mg/L	≈25	147	658
TSS	mg/L	≈25	208	1,016

Table 13. Influent Characterization - Elliott West

Parameter	Units	# of Samples	Average	Maximum
Volume	MG	41	42.5	200
			Average Monthly Average	Maximum Monthly Average
BOD ₅	mg/L	≈41	77	391
TSS	mg/L	≈41	150	706

Table 14. Influent Characterization - Henderson/MLK

Parameter	Units	# of Samples	Average	Maximum
Volume	MG	11	4.7	20.8
			Average Monthly Average	Maximum Monthly Average
BOD ₅	mg/L	≈11	23	45
TSS	mg/L	≈11	55	104

D. Wastewater effluent characterization

King County reported the concentration of pollutants in the discharge in the permit application and in discharge monitoring reports. The following tables summarize effluent quality for each facility from 2009-2013. The priority pollutant data presented contains only detectable compounds and elements with existing water quality criteria. More data is available in Appendix E.

Table 15. Effluent Characterization – West Point WWTP

Parameter	Units	# of Samples	Maximum Average Monthly	Maximum Average Weekly
CBOD ₅	mg/L	≈200	14	27
	lbs/day	≈200	13,000	33,200
TSS	mg/L	≈200	21	45
	lbs/day	≈200	21,500	61,300
			Maximum Monthly Geometric Mean	Maximum Weekly Geometric Mean
Fecal Coliform	cfu/100 mL	≈200	16	45
			Minimum	Maximum
pH	Std Units	continuous	6.0	7.8
			Maximum Monthly Average	Maximum Daily Maximum
Chlorine, Total Residual	µg/L	continuous	139	340
Ammonia, as N	mg/L	≈60	29	32
	lbs/day	≈60	19,867	27,700
Total Kjeldahl Nitrogen, as N	mg/L	≈60	31	33
Nitrate + Nitrite, as N	mg/L	≈60	10	10
Phosphorus, total, as P	mg/L	≈60	3.4	3.4
Phosphate, ortho, as P	mg/L	≈60	4.0	4.9
Dissolved Oxygen	Mg/L	3	8.4	10.6
			Minimum	Maximum
1,4-Dichlorobenzene	ug/L	9	1.0	10.2
2,4-Dichlorophenol	ug/L	9	0.12	0.96
2,4-Dimethylphenol	ug/L	9	0.24	0.48
Antimony, Total	ug/L	15	0.30	0.63
Arsenic, Total	ug/L	15	0.27	2.28
Bis(2-Ethylhexyl)Phthalate	ug/L	9	0.41	10.20
Boron, Total	ug/L	8	110	200
Cadmium, Total	ug/L	15	0.05	0.18
Chloroform	ug/L	9	1.00	5.68
Chromium, Total	ug/L	15	0.20	1.34
Copper, Total	ug/L	15	0.40	16.30
Cyanide, weak acid diss.	mg/L	15	0.005	0.006
Diethyl Phthalate	ug/L	9	0.120	0.850
Di-N-Octyl Phthalate	ug/L	9	0.071	0.360
Iron, Total	ug/L	8	110	661
Lead, Total	ug/L	15	0.10	2.51
Magnesium, Total	ug/L	8	6,040	10,300
Manganese, Total	ug/L	8	8.7	71.1
Mercury, Total	ug/L	27	0.002	0.016
Methylene Chloride	ug/L	9	5.0	5.3
Molybdenum, Total	ug/L	8	3.0	7.4
Naphthalene	ug/L	9	0.14	0.76
Nickel, Total	ug/L	23	0.1	6.5
Phenolics, Total	mg/L	15	0.040	0.090
Potassium, Total	ug/L	8	5,770	11,700
Pyrene	ug/L	9	0.071	0.290
Selenium, Total	ug/L	15	0.50	1.30
Silver, Total	ug/L	15	0.04	0.15
Sodium, Total	ug/L	8	34,200	54,700
Strontium, Total	ug/L	8	107	277
Sulfur, Total	ug/L	8	6,370	9,840
Thallium, Total	ug/L	15	0.040	0.130
Titanium, Total	ug/L	8	4.0	31.9
Toluene	ug/L	9	1.0	1.1
Zinc, Total	ug/L	23	10.7	54.2
			Value	
Temperature – 95 th percentile 1-DADMAX	°C	continuous	21.0	

Table 16. Effluent Characterization – Alki CSO TP

Parameter	Units	# of Samples	Average	Maximum
Volume	MG	19	9.8	41.7
			Average Monthly Average	Maximum Monthly Average
BOD ₅	mg/L	≈16	23	40
TSS	mg/L	≈16	34	65
			Maximum Monthly Geometric Mean	Maximum
Fecal Coliform	cfu/100 mL	16	1	20,000
			Minimum	Maximum
pH	Std Units	continuous	5.8	8.4
Chlorine, Total Residual	µg/L	continuous	0	1708
Ammonia, as N	mg/L	1	2.18	2.18
Total Kjeldahl Nitrogen, as N	mg/L	1	6.3	6.3
Nitrate + Nitrite, as N	mg/L	1	0.8	0.8
Phosphorus, total, as P	mg/L	1	0.84	0.84
Phosphate, ortho, as P	mg/L	1	0.6	0.6
Dissolved Oxygen	mg/L	4	10.2	10.6
Hardness, calc	mg CaCO ₃ /L	1	35.6	35.6
Alkalinity, total	mg CaCO ₃ /L	1	40.2	40.2
Antimony, Total, ICP-MS	ug/L	7	0.48	0.7
Arsenic, Total, ICP-MS	ug/L	7	1.85	2.28
Benzyl Butyl Phthalate	ug/L	7	0.071	0.43
Bis(2-Ethylhexyl)Phthalate	ug/L	7	0.46	3.65
Cadmium, Total, ICP-MS	ug/L	7	0.052	0.13
Chloroform	ug/L	7	1.5	14
Chromium, Total, ICP-MS	ug/L	7	1.47	2.2
Copper, Total, ICP-MS	ug/L	7	8.93	12.3
Cyanide, weak acid diss.	ug/L	6	5.0	18.3
Diethyl Phthalate	ug/L	7	0.51	3.69
Lead, Total, ICP-MS	ug/L	7	2.55	4.7
Mercury, Total	ug/L	7	0.021	0.025
Nickel, Total, ICP-MS	ug/L	7	2.83	3.37
Silver, Total, ICP-MS	ug/L	7	0.04	0.1
Zinc, Total, ICP-MS	ug/L	7	32.1	42.9
			Value	
Temperature – 95 th percentile 1-DADMAX	°C	continuous	No temp data available, used value from West Pt WWTP effluent: 21.0	

Table 17. Effluent Characterization – Carkeek CSO TP

Parameter	Units	# of Samples	Average	Maximum
Volume	MG	23	3.2	17.4
			Average Monthly Average	Maximum Monthly Average
BOD ₅	mg/L	≈12	38	132
TSS	mg/L	≈12	46	132
			Minimum Monthly Geometric Mean	Maximum
Fecal Coliform	cfu/100 mL	11	0	80,000
			Minimum	Maximum
pH	Std Units	continuous	5.1	7.9
Chlorine, Total Residual	µg/L	continuous	8	1370
Ammonia, as N	mg/L	4	1.66	3.35
Total Kjeldahl Nitrogen, as N	mg/L	4	4.57	9.44
Nitrate + Nitrite, as N	mg/L	4	1.18	2.15
Phosphorus, total, as P	mg/L	4	0.67	1.18
Phosphate, ortho, as P	mg/L	4	0.51	0.90
Dissolved Oxygen	mg/L	3	8.6	10.1
Hardness, calc	mg CaCO ₃ /L	4	35	48
Alkalinity, total	mg CaCO ₃ /L	4	27.5	49.3
2,4-Dichlorophenol	ug/L	9	0.12	0.89
Antimony, Total	ug/L	10	0.47	1.03
Arsenic, Total	ug/L	10	1.83	4.84
Benzo(b)fluoranthene	ug/L	5	0.75	2.91
Benzo(k)fluoranthene	ug/L	5	0.75	0.81
Benzyl Butyl Phthalate	ug/L	9	0.14	4.46
Bis(2-Ethylhexyl)Phthalate	ug/L	9	0.41	3.65
Cadmium, Total	ug/L	10	0.05	0.2
Chloroform	ug/L	8	1.5	64.3
Chloromethane	ug/L	8	1	1
Chromium, Total	ug/L	10	0.91	5.68
Copper, Total	ug/L	10	9.83	27.7
Cyanide, weak acid diss.	ug/L	17	5.0	20.1
Di-N-Butyl Phthalate	ug/L	9	0.12	0.63
Diethyl Phthalate	ug/L	9	0.28	1.54
Lead, Total	ug/L	10	1.55	11.3
Mercury, Total	ug/L	10	0.05	0.051
Nickel, Total	ug/L	10	1.71	4.63
Silver, Total	ug/L	10	0.04	0.3
Toluene	ug/L	8	1	3.52
Zinc, Total	ug/L	10	34	85
			Value	
Temperature – 95 th percentile 1-DADMAX	°C	continuous	No temp data available, used value from West Pt WWTP effluent: 21.0	

Table 18. Effluent Characterization – Elliott West CSO TP

Parameter	Units	# of Samples	Average	Maximum
Volume	MG	27	20.1	97.4
			Average Monthly Average	Maximum Monthly Average
BOD ₅	mg/L	≈27	69	191
TSS	mg/L	≈27	144	708
			Maximum Monthly Geometric Mean	Maximum Weekly Geometric Mean
Fecal Coliform	cfu/100 mL	≈26	400,000	412,500
			Minimum	Maximum
pH	Std Units	continuous	5.5	8.5
Chlorine, Total Residual	µg/L	continuous	607	860
Ammonia, as N	mg/L	2	2.54	2.68
Total Kjeldahl Nitrogen, as N	mg/L	2	7.65	9.07
Nitrate + Nitrite, as N	mg/L	2	0.35	0.45
Phosphorus, total, as P	mg/L	2	1.04	1.14
Phosphate, ortho, as P	mg/L	2	0.04	0.64
Dissolved Oxygen	mg/L	2	0.1	5.2
Alkalinity, total	mg CaCO ₃ /L	2	32.7	38.6
Hardness, calc	mg CaCO ₃ /L	1	31.9	31.9
1,4-Dichlorobenzene	ug/L	8	1	8.16
2,4-Dichlorophenol	ug/L	9	0.24	1
Antimony, Total, ICP-MS	ug/L	20	0.3	1.71
Arsenic, Total, ICP-MS	ug/L	20	0.46	2.66
Benzo(b)fluoranthene	ug/L	8	0.75	2.93
Benzo(k)fluoranthene	ug/L	8	0.75	1.6
Benzyl Butyl Phthalate	ug/L	9	0.41	1.42
Bis(2-Ethylhexyl)Phthalate	ug/L	9	2.05	6.85
Bromodichloromethane	ug/L	8	1	2
Cadmium, Total, ICP-MS	ug/L	20	0.05	0.617
Chloroform	ug/L	8	5.41	35.8
Chloromethane	ug/L	8	1	1.3
Chromium, Total, ICP-MS	ug/L	20	0.23	7.33
Copper, Total, ICP-MS	ug/L	20	23	86.7
Cyanide, weak acid diss.	ug/L	11	5.0	19.3
Diethyl Phthalate	ug/L	9	0.47	5.47
Dimethyl Phthalate	ug/L	9	0.179	0.4
Fluoranthene	ug/L	9	0.16	0.6
Lead, Total, ICP-MS	ug/L	20	0.39	26.8
Mercury, Total, CVAA	ug/L	9	0.05	0.088
Mercury, Total, CVAF	ug/L	1	0.0272	0.0272
Nickel, Total, ICP-MS	ug/L	20	0.1	6.34
Pentachlorophenol	ug/L	9	0.47	1.91
Pyrene	ug/L	9	0.18	0.6
Selenium, Total, ICP-MS	ug/L	20	0.5	0.61
Silver, Total, ICP-MS	ug/L	20	0.05	1.9
Thallium, Total, ICP-MS	ug/L	20	0.04	0.268
Toluene	ug/L	8	1	32.8
Zinc, Total, ICP-MS	ug/L	20	2.8	162
			Value	
Temperature – 95 th percentile 1-DADMAX	°C	continuous	No temp data available, used value from West Pt WWTP effluent: 21.0	

Table 19. Effluent Characterization – Henderson/MLK CSO TP

Parameter	Units	# of Samples	Average	Maximum
Volume	MG	11	2.3	16.6
			Minimum	Maximum
BOD ₅	mg/L	≈4	5	16
TSS	mg/L	≈4	31	45
Fecal Coliform	cfu/100 mL	≈4	1	302,667
pH	Std Units	≈4	6.7	7.0
Chlorine, Total Residual	µg/L	≈4	13	218
Ammonia, as N	mg/L	1	0.73	0.73
Total Kjeldahl Nitrogen, as N	mg/L	1	3.86	3.86
Nitrate + Nitrite, as N	mg/L	1	2.21	2.21
Phosphorus, total, as P	mg/L	1	0.54	0.54
Phosphate, ortho, as P	mg/L	1	0.27	0.27
Dissolved Oxygen, mg/L	mg/L	3	8.4	10.6
Hardness, calc	mg CaCO ₃ /L	1	48.3	48.3
Alkalinity, total	mg CaCO ₃ /L	1	33.5	33.5
2,4-Dichlorophenol	ug/L	3	0.24	2.54
Antimony, Total	ug/L	3	0.77	0.89
Arsenic, Total	ug/L	3	1.81	2.08
Bis(2-Ethylhexyl)Phthalate	ug/L	3	0.732	1.33
Bromodichloromethane	ug/L	3	1	1.5
Cadmium, Total	ug/L	3	0.05	0.073
Chloroform	ug/L	3	1	50.1
Chromium, Total	ug/L	3	1.56	2.4
Copper, Total	ug/L	3	10.1	12.3
Cyanide, weak acid diss.	ug/L	6	5.0	6.5
Di-N-Butyl Phthalate	ug/L	3	0.24	1.49
Diethyl Phthalate	ug/L	3	0.34	0.47
Dimethyl Phthalate	ug/L	3	0.11	0.2
Lead, Total	ug/L	3	3.02	4.23
Mercury, Total	ug/L	3	0.05	0.05
Nickel, Total	ug/L	3	1.92	3.31
Phenol	ug/L	3	1.9	6.72
Zinc, Total	ug/L	3	30.1	40.2
			Value	
Temperature - 7-DADMAX	°C	continuous	No temp data available, used value from West Pt WWTP effluent: 21.0	

Whole Effluent Toxicity Testing - West Point WWTP

King County conducted acute and chronic toxicity testing in January 2012, April 2012, July 2012, and October 2012. Acute toxicity tests were conducted with *Daphnia pulex* and fathead minnow. Chronic toxicity tests were conducted with Atlantic mysid and topsmelt. See Appendix E for toxicity test results.

For acute toxicity, the performance standard requires median survival in 100% effluent at levels equal to or greater than 80%, and no individual test result showing less than 65% survival in 100% effluent. All toxicity tests performed in 2012 met these performance standards.

For chronic toxicity, the performance standard requires that no chronic toxicity test demonstrates a statistically-significant difference in response between the control and a test concentration equal to the acute critical effluent concentration (ACEC). West Point had no chronic toxicity anywhere near the ACEC of 3.1% effluent in any recent test.

No WET limits are required. The proposed permit includes the same set of WET tests at the end of the next permit term to meet the application submission requirements.

E. Sediment characterization

West Point WWTP Outfall

Sediment testing in 1998³, 2000⁴, 2006⁵, and 2011⁶ occurred at 12 to 19 stations and included chemistry, bioassays, and benthic surveys as shown in Table 20. The results are compared to the Sediment Quality Standards (SQS) criteria for marine water. The sediment sampling stations for the 2011 sampling report are shown in Figure 7.

Table 20. West Point WWTP – Sediment Test Results

Year	Chemistry # of stations	Bioassays # of stations	Benthic Surveys*	SQS Hits	Stations
2011-July	1	8 –Larval echinoderm only	0	Bioassays	WP430S (no chemistry hits to support toxicity, and TIE conducted by King County indicates toxicity was likely due to sample turbidity and not chemically induced)
2011- April	8	8	0	Chemistry & Bioassays	WP230P: Total PCB WP420NW: Total PCB WP215N: Dimethyl Phthalate
2006	19	10	10	Bioassays	WP280W WP230P WP215N
2000	12	2	6	Bioassays	WP230P WP430N
1998	12	2	5	Chemistry & Bioassays	WP230P WP430N

* Unable to determine compliance with Sediment Management Standards for the benthic surveys due to lack of reference station.

³ King County 1998. *SEDQUAL* data WPNT98.

⁴ King County 2000. *SEDQUAL* data WPNT00.

⁵ King County 2006. *West Point Wastewater Treatment Plant 2006 Outfall Sediment Sampling Event Final Report*.

⁶ King County, letters to Ecology (Henley) dated July 12, 2011 and February 16, 2012. *EIM* data WPNT00

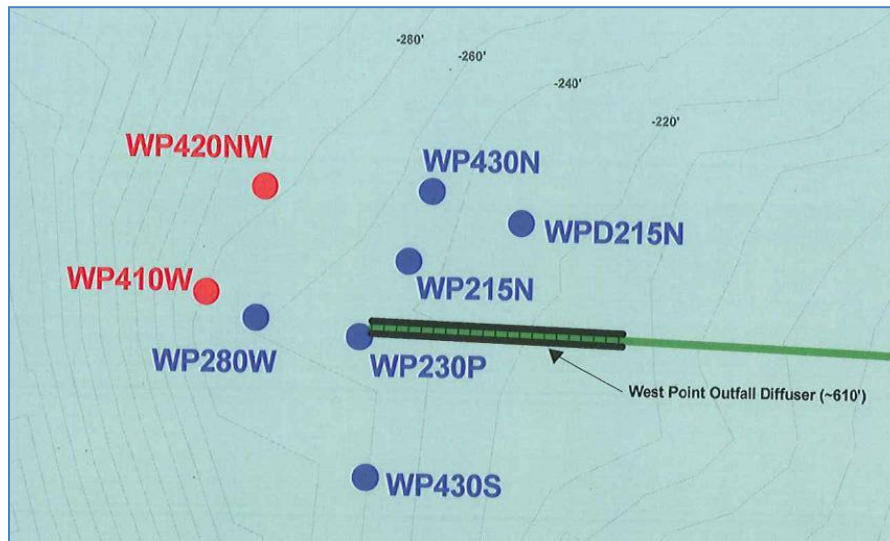

Figure 7. Sediment sampling locations for West Pt WWTP outfall

All detected concentrations have met the SQS chemical numeric standards (1988 Lowest Apparent Effects Threshold - LAET) except for one station in 1998 and 3 stations in April 2011. Due to low organic carbon content, chemical concentrations were compared to the 1988 LAET dry weight thresholds that are the basis for the organic carbon-normalized criteria in the Sediment Management Standards. Testing in April 2011 resulted in total PCB exceedances at stations WP230P and WP420NW, and a dimethyl phthalate exceedance at station WP215N. Although a few stations had elevated levels of Polycyclic Aromatic Hydrocarbons (PAH), all met the chemical criteria in 2006. In 2000, some samples had Method Detection Limits (MDL) above SQS for Hexachlorobutadiene, but it also was not detected in the influent or effluent. In 1998, there were 42 non-detects and 5 detected concentrations above SQS. The five detected exceedances all occurred at one station, WP230P, and included benzo(g,h,i)perylene, fluoranthene, indeno(c,d)pyrene, phenanthrene, and pyrene (all PAH compounds).

Bioassay test results have shown toxicity at several stations over the years. The following stations have failed one or more bioassay test: WP280W, WP230P, WP215N, and WP430N. Some of these stations coincide with elevated concentrations of PAH compounds. The sediments at Station WP280W failed all three bioassay tests in 2006, but no elevated chemicals were detected. The sediments at station WP230P failed bioassay tests in 1998, 2000, and 2006, but passed in 2011. In April 2011, Station WP430S showed a bioassay hit but again toxicity was not supported with elevated chemical concentrations, and a TIE (toxics identification evaluation) conducted by King County showed that the toxicity was likely a result of physical characteristics (i.e., sample turbidity) and not chemically induced.

In 1998 and 2000, benthic surveys showed benthic abundance and diversity were reduced at two stations (WP230P, WP430N) compared to the other sites near the outfall. These two stations also had bioassay toxicity. In 2006, no differences were evident between the stations. Ecology cannot compare benthic data to the SQS criteria because no reference station data was collected. Benthic surveys were not conducted in 2011.

In summary, King County has conducted sediment analyses near the West Point WWTP outfall five times in the past sixteen years (1998, 2000, 2006, April 2011, and July 2011). Many of the stations have consistently shown no indication of chemical or biological effects.

Except for one station in 1998 and three stations in 2011, all detected concentrations met the SQS chemical numeric standards. Bioassay test results have consistently shown apparent sediment toxicity at a few stations, but cause of toxicity is unclear based on chemistry results and on the TIE conducted by King County in 2011. Benthic surveys showed that in 1998 and 2000, benthic abundance and diversity were reduced at the two stations that also had bioassay toxicity (WP230P, WP430N), but this was not evident in 2006. Sediment monitoring will continue in the vicinity of the outfall with more focus on investigating the area which has shown some evidence of sediment impacts.

Alki CSO Treatment Plant Outfall

King County has sampled sediments near the Alki CSO treatment plant on several occasions, most recently in October 2001. The study evaluated sediments at six stations; five of the stations formed a transect perpendicular to the end of the outfall and the sixth station was located approximately 1,500 feet from the outfall. All detected chemical concentrations were less than their respective SQS criteria or LAET values. Data from this sampling event can be found in EIM under User Study ID ALKI01.⁷ No additional sediment monitoring is planned at this outfall because there were no SMS exceedances in the last round of sampling and source conditions have not changed

Carkeek CSO Treatment Plant Outfall

King County has sampled sediments near the Carkeek CSO treatment plant on several occasions, most recently in October 2000. The study evaluated sediments at six stations; five of the stations formed a transect perpendicular to the end of the outfall and the sixth station was located approximately 1,500 feet from the outfall in the direction of the prevailing current. All detected chemical concentrations were less than their respective SQS criteria or LAET values. Data from this sampling event can be found in EIM under User Study ID CARKEK00.⁷ No additional sediment monitoring is planned at this outfall because there were no SMS exceedances in the last round of sampling and source conditions have not changed.

Elliott West CSO Treatment Plant Outfall

King County has sampled sediments near the Elliott West CSO treatment plant and the Denny Way CSO extensively. The most recent sediment monitoring program has been in effect since 2001 as part of the Denny Way/Lake Union CSO Control Project long-term sediment monitoring program. The County collected samples from 16 locations near the two outfalls in 2001, 2003, 2004, 2006, 2007, 2008, and 2009⁷. Several chemicals exceeded either SQS and/or Clean-up Screening Level (CSL) chemical criteria at one or more locations. These include total PCBs, benzo(a)anthracene, benzo(a)pyrene, benzo(g,h,i)perylene, benzyl butyl phthalate, bis(2-ethylhexyl) phthalate, chrysene, dibenzo(a,h)anthracene, fluoroanthene, indeno(1,2,3-c,d)pyrene, and mercury. Sediment characterization is ongoing and an interim cleanup plan has been developed for this outfall and the Denny Way Regulator.⁸ Since sediment characterization is on-going and an interim cleanup plan has been developed as part of cleanup efforts, additional sediment monitoring requirements have not been imposed in this permit. Table 21 details King County's sediment remediation activity in the vicinity of the Elliott West CSO treatment plant outfall.

⁷ King County, *Comprehensive Sediment Quality Summary Report for CSO Discharge Locations*, 2009.

⁸ King County, *Post Construction Monitoring Plan for King County CSO Controls*, Sept 2012.

Table 21. Elliott West CSO treatment plant outfall – sediment remediation activity 7

1986	Metro began a trial program to identify and reduce toxicant inputs to the sewer system discharging through the Denny Way CSO.
1990	King County and the U.S. Army Corps of Engineers (Corps) sponsored the Denny Way CSO capping project to test the feasibility of capping contaminated sediments in Elliott Bay with clean dredged material from the Duwamish Waterway. A 3-foot layer of clean sand, dredged from the upper Duwamish Waterway during routine maintenance, was placed over a 3-acre area in water depths ranging from approximately -25 to -60 feet mean lower low water (MLLW). Monitoring results show that the cap was stable, was not eroding, and had successfully isolated the underlying contaminated sediments ⁹ . However, chemical concentrations on the cap surface layer (offshore of the Denny Way CSO) increased after cap construction, suggesting possible recontamination from the continued CSO discharges from Denny Way or potential redistribution of remaining contaminated sediments from the intertidal area and the inshore edge of the cap.
1997	King County characterized the nature and extent of surface and subsurface sediment contamination in the outfall area and in areas inshore and offshore of the existing sediment cap ¹⁰ . Follow-up sediment sampling conducted by King County in 2005 demonstrated that chemical concentrations in the offshore areas declined over time due to a combination of natural processes, including biodegradation of chemicals, accumulation and mixing of clean sediment, and reduction of contaminant sources ⁹ . Thus, monitored natural recovery is a prospective cleanup remedy for the offshore areas. Sediments sampled within inshore areas of the site contained concentrations of cadmium, copper, lead, mercury, silver, polycyclic aromatic hydrocarbons (PAHs), polychlorinated biphenyls (PCBs), bis(2-ethylhexyl)phthalate, and butyl benzyl phthalate that exceeded SQS chemical criteria. Contaminant concentrations above SQS chemical criteria were present to a depth of approximately 10 feet below the existing mudline. Unlike offshore areas of the site, natural recovery rates in the inshore sediment areas appeared to be progressing relatively slowly. In order to accelerate cleanup of the site and minimize the risk of future recontamination to other site areas, including the offshore cap, an interim sediment cleanup action plan for the site was developed by King County and Ecology in 2007 that included dredging to the maximum extent practicable to remove contaminated sediments and backfilling to restore the grade to close to pre-project conditions.
2002	The County constructed a new outfall to extend CSO discharge location further offshore.
2006	Primary treatment and disinfection began for most of the discharges from this CSO (Elliott West CSO).
2007-2008	Under an Ecology Agreed Order, the County completed an interim action to clean up contaminated sediments in two near-shore areas in the immediate vicinity of the former Denny Way CSO outfall. A combination of dredging, backfilling, and armoring was employed to remediate the near-shore areas. King County dredged approximately 13,700 cubic yards of contaminated sediments and associated side slopes. The dredged area was backfilled and armored with an average thickness of more than 8 feet of material. Approximately 11,886 cy of well-graded clean sand was armored with approximately 4,821 cy of sandy-gravel habitat mix and with large cobbles and boulders. An additional 1,540 cy of well-graded clean sand was placed in an approximate 6-inch-thick layer around the perimeter of the dredge prism to address any residuals that may have resulted from the dredging. Sediment monitoring continued until 2012 to satisfy the National Marine Fisheries Service Biological Opinion. ¹¹

Henderson/MLK CSO Treatment Plant Outfall

Table 22 summarizes sediment remediation activity for the Henderson/MLK outfall area. Sediment sampling in this part of the Duwamish River has been characterized by Windward¹² as part of the ongoing Lower Duwamish Waterway Superfund action. Sediment sampling off the Norfolk CSO/storm drain was conducted over three rounds from 1994

⁹ King County. 2005. *The Denny Way sediment cap – 2000 data – final monitoring report*.

¹⁰ King County. 1999. *Sediment remediation plan, Denny Way/Lake Union CSO Control Project*.

¹¹ King County 2008. *Denny Way CSO and Elliott West CSO Treatment Facility, Post-Construction Sediment Monitoring Sampling and Analysis Plan*.

¹² Windward Environmental LLC. 2008. *Lower Duwamish Waterway remedial investigation, remedial investigation report, draft final (internal)*.

through 1995 under the Elliott Bay/Duwamish Restoration Program¹³. Both surface and subsurface sampling was extensively conducted within several hundred feet of the outfall to determine the remediation boundaries. SMS exceedances included mercury, total PCBs, 1,4 dichlorobenzene, and bis(2-ethylhexyl)phthalate. The SQS was used to set the remediation boundaries. Data from this study may be found in EIM under User Study ID NRFK9495.⁷

The 1999 remediation project was monitored for a period of five years to evaluate possible recontamination of the backfill sediment as a result of continuing CSO discharges. The monitoring was completed in 2005. The site is now under evaluation as part of the early action sites in the Superfund area. More information on Norfolk CSO sediment remediation can be found on King County's website at:

<http://www.kingcounty.gov/environment/wastewater/SedimentManagement/Projects/Norfolk/Library.aspx>.

Ecology does not expect significant recontamination from the CSO discharges during this permit term for the following reasons:

- The Henderson/MLK CSO facility discharges infrequently, only 1-3 times each year,
- The basin that feeds the facility is largely residential with few industrial users, therefore toxic pollutant loads are expected to be smaller,
- The facility provides some settling therefore fewer solids are discharged,
- The facility often retains 'first flush' stormwater (when the tunnel fills but does not discharge) and sends these more contaminated flows to a wastewater treatment plant for additional treatment.

Since the site is under sediment evaluations as part of Superfund cleanup efforts, additional sediment monitoring at the Norfolk CSO outfall is not required in this permit. Additional sediment concerns from other contaminant sources will be addressed through Lower Duwamish Waterway sediment cleanup projects.

Table 22. Henderson/MLK CSO treatment plant outfall – sediment remediation activity⁷

1991	To implement the requirements of a 1991 Consent Decree defining the terms of a natural resources damage agreement, the Elliott Bay/Duwamish Restoration Program (EBDRP) was established. Program oversight is provided by the EBDRP Panel, which is composed of federal, state, and tribal natural resource trustees, the Municipality of Metropolitan Seattle (which subsequently became part of King County government and is now the King County Department of Natural Resources and Parks (KCDNRP), and the City of Seattle (City). The goals of the EBDRP include remediation of contaminated sediments associated with KCDNRP and City CSOs and storm drains, restoration of habitat in Elliott Bay and the Duwamish River, and control of potential sources of contaminants from the outfalls.
1992	A Sediment Remediation Technical Working Group (SRTWG) was established by the EBDRP Panel to address contaminated sediment issues. The SRTWG identified 24 potential sediment remediation sites associated with KCDNRP and City CSOs and storm drains. These sites were evaluated against several criteria, which included extent of contamination, degree of source control near sites, and public input, as reported in the Final Concept Document. Ultimately, the SRTWG selected three sites (the Duwamish Pump Station CSO and Diagonal Way CSO/storm drain, the Norfolk CSO, and the Seattle Waterfront) for further investigation.
1994	A plan to investigate the extent of contamination at the Norfolk CSO was prepared by KCDNRP (then Metro) on behalf of the EBDRP Panel. KCDNRP implemented field data collection activities between August 1994 and December 1995. The primary goals were to determine the extent of sediment contamination around the Norfolk CSO outfall, based on comparison to SMS criteria and to determine a preferred remedial alternative for the site.

¹³ King County. 1996. Norfolk CSO cleanup study report.

1999	Site remediation began in February 1999 and was completed in March 1999. Activities consisted of dredging approximately 2 acres of contaminated sediment and backfilling the dredged area to original grade with clean sediment. A dredging dept of 3-9 feet resulted in 5,190 cubic yards of sediment removal.
2003	Elevated PCB concentrations (greater than the SQS criterion or LAET) indicated that cap recontamination was occurring. In response, Boeing conducted a cleanup of river sediments at a stormwater outfall adjacent to the Norfolk CSO outfall using a specialized vacuum excavator; approximately 100 cubic yards of sediment were removed.
2004	King County completed post-remedial monitoring at the Norfolk outfall, and reported (<i>King County, June 2005</i>) sporadic SMS exceedances on the sediment cap without a consistent upward trend. The five-year monitoring period did not show surface recontamination from CSO discharges to levels approaching SQS chemical criteria.

Untreated CSO Outfalls

Sediment monitoring at CSO locations is a complex situation at many locations, some in different stages of cleanup under different authorities. Several CSOs discharge into Superfund cleanup sites so King County is coordinating with other agencies on source control and cleanup of larger areas. Cleanups done under CERCLA and MTCA may have short-term monitoring, but rely on other authorities, such as NPDES permits under the Clean Water Act to address long-term monitoring. This NPDES permit has a role in assuring discharges are in compliance with the Sediment Management Standards, but it is necessary to coordinate these efforts with cleanup investigations and actions under state and federal authorities.

The County's *1999 Sediment Management Plan*¹⁴ developed remedial strategies for correcting short- and long-term hazards associated with contaminated sediments near King County CSO sites. In 2011 and 2013 the County collected sediment data at several CSO outfall locations to update their Sediment Management Plan (SMP). King County is using this data to calibrate and validate a near-field sediment model that will be used to evaluate recontamination potential for CSOs following control and sediment remediation projects. An updated SMP is expected in 2015.

In 2009 King County provided Ecology with a *Comprehensive Sediment Quality Summary Report* that summarizes sediment data collected up until 2009 for all of King County's CSO outfalls. The County has conducted sediment monitoring at most CSO outfalls to assess CSO impacts and to determine if remediation is needed. King County's 2012 *Post Construction Monitoring Plan* also provides a brief summary of the sediment samples that have been collected near each CSO discharge location.

King County outlined their post construction monitoring program for sediments in their 2012 *Post Construction Monitoring Plan* (PCMP). Post construction sediment monitoring requires site characterization using modeling and/or sediment quality samples. King County, in consultation with Ecology, will determine what comprises an adequate site characterization on a site specific basis. Based on the site characterization, certain CSO discharge locations may exceed Sediment Management Standards (SMS). For these locations, King County will develop site-specific sediment clean-up plans. Clean-up plans will contain actions required to meet the SMS as well as a sampling program to ensure the outcome has been achieved and recontamination is not occurring.

¹⁴ King County, 1999.

For untreated CSOs discharging to the Puget Sound, sediment data show either no exceedances of SQS or a single exceedance of a phthalate compound, except for the Barton CSO site. For the Barton CSO outfall, the 2011 sediment monitoring results show multiple exceedances of SQS and CSL for several parameters (likely contributed to by other sources). For untreated CSOs discharging to Elliott Bay and the Duwamish River, sediment quality data show multiple exceedances of SQS, often including PAHs, total PCBs, phthalate compounds, and some metals. CSOs discharging into Lake Washington and the Ship Canal have multiple exceedances of the freshwater sediment guidelines for metals, total PCBs, PAHs, phthalate compounds, and other organic compounds.

Table 23 lists sediment remediation activities King County has undertaken to improve sediment quality near untreated CSO outfall locations.

Based on the County's 2009 *Sediment Quality Summary Report*, Ecology prioritized sampling at the County's 38 untreated CSO locations into categories of high, medium, or low (*Ecology memo, Podger, 2010*). Ecology based prioritization on discharge characteristics (volume and frequency, treatment), past sediment data results, and impact of other activities (cleanups pending or completed, construction pending, monitoring under other authorities). However the predominant metric used for ranking was average discharge flow from 2001-2007, in which discharges less than 1 million gallons (MG) average per year were rated low, 1-10 MG/year were rated as medium, and >10 MG/year were rated as high priority. Locations with primary treatment and with diffusers were also rated lower than untreated single-pipe discharges. CSOs ranked with high and medium priorities are listed in Table 24 along with sampling results from 2011 and 2013. The table also lists low priority CSOs that were tested in 2011/2013.

Table 23. Untreated CSO outfalls – sediment remediation activity

1999	King County developed a Sediment Management Plan that identified seven contaminated sediment sites near CSO discharges. ¹⁵ Four of those sites have cleanup actions planned or completed including Denny Way, Norfolk, Diagonal/Duwamish, and Hanford/Landers.
2000	King County, the Boeing Company, the City of Seattle (the City), and the Port (the Lower Duwamish Waterway Group or LDWG) completed a voluntary agreement to begin investigation of the LDW sediments, toward an ultimate waterway cleanup plan.
2003	The Diagonal/Duwamish cleanup included dredging and capping of seven acres of contaminated sediment along the Lower Duwamish River. Post-cleanup monitoring continued for five years. ¹⁶
2003-2006	The County and City, as operators of the local sanitary sewer and stormwater drainage systems, worked together to inspect more than 1,000 Lower Duwamish Waterway businesses to reduce pollutants discharged to the Lower Duwamish.
2003-present	The County worked in partnership with the Port on the Harbor Island Superfund project. The project will remediate sediments at the County's Lander St and Hanford St CSOs.
2004	The County participated in two early action sites—the Diagonal/Duwamish CSO/Storm Drain and Slip 4 CSO. King County removed 66,000 cubic yards of contaminated sediment at the Duwamish CSO outfall and Diagonal storm drain.
2005	King County placed a thin sand layer over four acres adjacent to the Duwamish CSO outfall and Diagonal storm drain cleanup site to control residuals from the dredging and to compare enhanced natural recovery to monitored natural recovery in that portion of the LDW.
2007-present	The County's Industrial Waste Program works with other agencies to conduct pollution source control inspections at Lower Duwamish Waterway businesses as part of the Urban Waters Initiative, an interagency coordination effort of Ecology. The initiative provides increased resources to speed up pollution reduction efforts to benefit the waters, sediments, and human and marine inhabitants of the Lower Duwamish Waterway.

¹⁵ King County 1999. *King County Department of Natural Resources Year 2000 CSO Plan Update Project, Sediment Management Plan*.

¹⁶ Ecology 2002. *Final Sediment Management Standards Cleanup Action Decision Duwamish/Diagonal CSO/SD*.

2008-2009	As part of the Duwamish East Waterway Superfund site, the County removed approximately 20,000 cubic yards of sediment in front of the Lander CSO.
2012	WTD partnered with the City, the Port, and Boeing under a consent agreement with EPA and Ecology to prepare a remedial investigation and feasibility study for the Lower Duwamish Waterway Superfund Site. The feasibility study described 11 cleanup alternatives. In 2012 EPA proposed a cleanup plan based on the 2010 <i>Lower Duwamish Waterway Draft Final Feasibility Study</i> .
2012	King County developed a sediment transport model to better assess impacts from CSO discharges.
present	Ecology leads the Source Control Work Group that includes EPA, Seattle Public Utilities (SPU), the King County Industrial Waste Program, the Port of Seattle, the Puget Sound Clean Air Agency, and the City of Tukwila. This group meets monthly to coordinate source control efforts and make it easier for businesses to identify and control pollutant sources. The group's first priority is to address the early action areas identified for sediment cleanup. The group is working on controlling sources of contaminants that may pose health or environmental problems if they accumulate in waterway sediments. More information is available on the group's website at: http://www.ldwg.org/ and at http://www.ecy.wa.gov/programs/tcp/sites_brochure/lower_duwamish/lower_duwamish_hp.html .
present	The County is in the process of updating its 1999 Sediment Management Plan in coordination with new requirements for characterization and Post- Construction Monitoring.
present	The Wastewater Division's Sediment Management Program is coordinating expanded source control to identify and control the sources of pollution that may pose health or environmental problems if they accumulate in Duwamish Waterway sediments or re-contaminate cleanup areas. The Industrial Waste Program, Water and Land Resources Division and KC Airport are some of the groups involved with the current expanded source control efforts in King County.

Table 24. Sediment testing priorities for CSO outfalls & sampling results from 2011 & 2013

CSO Outfall	2010 Comments from Ecology ¹	2011 & 2013 Sampling Results ²	Future Monitoring / Cleanup
High Priority			
028-King Street	15+ year old sediment data with multiple hits, not cleanup site.	<i>Not tested.</i>	Treatment plant constructed in 2026. Sediments to be sampled prior to construction.
029-Kingdome			
036 - Chelan	Harbor Island superfund site. Sediment impairment in 1996 samples but EPA signed a 'No Further Action' on the site. No additional monitoring planned.	2011: 5 of the 6 sites exceeded SQS for 2 to several chemicals, 1 site exceeded CSL for 1 chemical (many NDs exceeded criteria). 2013: 1 site had dimethyl phthalate SQS exceedance, many NDs exceed criteria. <i>HPAHs, PCBs, phthalates</i>	Storage tank constructed in 2023. Sediments to be sampled post-construction.
037 - Harbor Avenue		<i>Not tested.</i>	Area-wide cleanup in progress. To be sampled when complete or when CSO controlled.
041- Brandon Street	Large discharge with high metals concentrations, little sediment data available.	2011: 4 of the 6 sites exceeded SQS for 1 to several chemicals, 3 sites exceeded CSL for 1 to several chemicals. <i>HPAHs, LPAH, PCBs, phthalate</i>	Treatment plant constructed by 2022. Sediments to be sampled prior to construction or with area-wide clean-up effort.
015- University	Large discharge with no recent sediment data	2011: 5 of the 7 sites had SCO or CSL exceedances. 2013: 3 of the 5 sites had SCO or CSL exceedances. <i>Phthalates, mercury, lead, nickel, silver, PCBs</i>	Storage tank constructed in 2028. Sediments to be sampled post-construction or with area-wide clean-up effort.
014- Montlake	Medium discharges and 10-20 year old sediment data show elevated PAH and other chemicals. [Last sampled in 2001, single site (KC 2009)].	2011: 2 of the 7 sites had SCO exceedances, no sites had CSL exceedances. <i>Arsenic, lead</i>	Storage tank constructed in 2028. Sediments to be sampled post-construction or with area-wide effort.
008- 3 rd Ave West		2011: 6 of the 7 sites exceeded SQS levels for 3 to 5 chemicals, 6 sites exceeded CSL for 2-5 chemicals. <i>Phthalates, nickel, silver, PCBs, phenol, total PAHs, mercury</i>	Storage tank constructed in 2023. Sediments to be sampled post-construction or with area-wide effort.

CSO Outfall	2010 Comments from Ecology ¹	2011 & 2013 Sampling Results ²	Future Monitoring / Cleanup
009- Dexter Ave 003- Ballard		<i>Not tested.</i>	Area-wide cleanup projects expected. CSO projects completed but not yet deemed controlled. Sediments to be sampled after outfalls deemed controlled or area-wide cleanup projects completed.
013/045- MLK and Henderson PS	CSO controlled since 2005 but had medium discharges in the past. Sediment data from 2005 had high PAH, phthalates, zinc.	<i>Not tested.</i>	Sediments characterized during this permit term.
Medium Priority			
044- Norfolk	Sediment data with hits or increasing trends.	<i>Not tested.</i>	CSO treatment plant outfall. Area-wide clean-up and monitoring complete. See discussion for Henderson/MLK TP above.
038- Terminal 115		<i>Not tested.</i>	Storage pipe constructed by 2025. Sediments to be sampled prior to construction or with area-wide clean-up effort.
039- S Michigan		<i>Not tested.</i>	Treatment plant constructed by 2022. Sediments to be sampled prior to construction or with area-wide clean-up effort.
Low Priority (does not include all outfalls, only sites tested in 2011/2013 and those with proposed monitoring)			
048- North Beach		2011: No SMS exceedances at 6 sites. 2013: No SMS exceedances at 5 sites.	CSO project in progress. No further action.
006- South Magnolia		2011: No SMS exceedances at 6 sites. 2013: No SMS exceedances at 1 site.	CSO project in progress. No further action.
056- Murray Avenue		2011: Benzyl Butyl Phthalate exceeded SQS at 1 site, no exceedances at remaining 6 sites. 2013: 1 site had SQS and CSL exceedances, no exceedances at remaining 5 sites. <i>Phthalate, LPAHs, HPAHs</i>	CSO project in progress. Site evaluation and possible clean-up plan as required by PCMP.
057- Barton Street		2011: 6 of 6 sites exceeded several SQS and CSL criteria. <i>HPAHs, LPAHs, phthalates, dibenzofuran</i>	CSO project in progress. Site evaluation and possible clean-up plan as required by PCMP.
052- 53rd Avenue		2011: No SMS exceedances at 6 sites.	CSO controlled. No further action.
012/049- Belvoir & 30 th Ave NE PS		2013: 1 site tested; 2 SCO and no CSL exceedances. <i>Total DDEs, bis(2-ethylhexyl)phthalate</i>	CSO controlled. Sediments to be characterized during this permit term due to SMS exceedances.
011- E. Pine Street PS Emergency Overflow		<i>Not tested.</i>	CSOs controlled. Low volume discharges with no recent data. Sediments to be characterized during this permit term to confirm meet water quality standards, consistent with County's 2012
018 - Matthews Park PS Emergency Overflow		<i>Not tested.</i>	

CSO Outfall	2010 Comments from Ecology ¹	2011 & 2013 Sampling Results ²	Future Monitoring / Cleanup
033-Rainier Avenue PS Emergency Overflow		Not tested.	PCMP.

¹ Source: Ecology TCP memo on review of KC's 2009 Sediment Quality Report (Podger), 2010.

² Sampling performed according to Ecology-approved KC CSO Sediment Quality Characterization Final Sampling and Analysis Plan, August 2011.

King County must model and/or sample sediments in accordance with the approved 2012 *Post Construction Monitoring Plan* or any approved plan revisions. Post construction monitoring of sediments is required with the completion of CSO projects once the CSO has been deemed controlled. If an area-wide cleanup project is planned, sediment samples must be collected once the project is complete.

During this permit term, the CSOs listed in Table 25 are scheduled to be controlled. The proposed permit requires submittal of a Post-Construction Summary Report that summarizes post construction sediment data and any clean-up actions performed. Anticipated monitoring is also described in the table.

Table 25. CSO outfalls scheduled to be controlled during this permit term

CSO Outfall	Anticipated Sediment Monitoring / Cleanup
Dexter Avenue Regulator (DSN 009)	Area-wide clean-up anticipated.
Denny Way Regulator (DSN 027a)	Area-wide clean-up in progress.
Harbor Avenue Regulator (DSN 037)	Area-wide clean-up in progress.
Ballard Siphon Regulator (DSN 003)	Area-wide clean-up anticipated.
Barton (DSN 057)	Post Construction monitoring and clean-up plan required by PCMP.
Murray (DSN 056)	
South Magnolia (DSN 006)	No additional sediment monitoring; pre-project monitoring showed no SMS exceedances.
North Beach (DSN 048)	

Hanford #1 - Construction of the Hanford #1 CSO project will begin during this permit term and must be completed by December 31, 2019 according to the County's consent decree. Since the project does not include in-water work the County will not perform pre-project sediment monitoring according to their PCMP (King County, September 2012). An area-wide cleanup effort is in progress in the vicinity of the diagonal stormwater drain outfall through which the Hanford #1 CSO discharges. According to the PCMP, the County will assess sediment quality in the vicinity of the outfall following completion of the CSO control project or cleanup project. This assessment will be conducted by modeling, collecting sediment samples, and/or assessing recent sediment data. No pre-project monitoring is required with the proposed permit. A post-construction monitoring report will be required in the next permit term.

F. Summary of compliance with previous permit issued

Ecology assessed compliance based the facilities’ discharge monitoring reports (DMRs), annual CSO reports, and inspections.

West Point WWTP

The West Point WWTP consistently complied with the effluent limits and permit conditions throughout the duration of the permit term. The County reported no effluent limit violations for CBOD₅, TSS, pH, total residual chlorine, or fecal coliform for the period July 1, 2009 to October 2013.

Alki CSO Treatment Plant

For the Alki CSO treatment plant, the previous permit placed effluent limits on TSS, fecal coliform, settleable solids, pH, and chlorine. Table 26 summarizes the violations and permit triggers that occurred from July 2009 through September 2013.

Table 26. Alki CSO Treatment Plant – Permit Violations

Date	Parameter	Statistical Base	Units	Value	Limit
10/1/2009	Fecal Coliform	Geometric Mean	#/100ml	20000	400
11/1/2009	Chlorine, Total residual	Daily Maximum	µg/L	684	234
1/1/2010	Chlorine, Total residual	Daily Maximum	µg/L	1708	234
11/1/2010	Chlorine, Total residual	Daily Maximum	µg/L	513	234
12/1/2010	Chlorine, Total residual	Daily Maximum	µg/L	503	234
3/1/2011	pH, Daily Min	Minimum	Std Units	5.8	6.0-9.0
11/1/2011	Fecal Coliform	Geometric Mean	#/100ml	18150	400
1/1/2012	Fecal Coliform	Geometric Mean	#/100ml	2157	400
9/1/2013	pH, Daily Min	Minimum	Std Units	5.8	6.0-9.0

In 2009 and 2010 the facility struggled to meet chlorine limits, as shown in Table 26. The facility exceeded chlorine limits by a wide margin four times during this period. King County responded to these violations by correcting a PLC programming error and by increasing SBS dosing capacity.

The facility continues to experience occasional fecal coliform exceedances. During this compliance period the facility exceeded the fecal limit three times. In response to these permit violations the County increased chlorine residual levels. They also lowered the hypochlorite solution concentration from 4% to 2% to allow for finer control, minimizing the risk of overdosing. The County also improved sample collection procedures to minimize cross-contamination.

Twice during the compliance period effluent pH dropped below 6.0 due to sodium bisulfate feed rates and low-alkalinity stormwater. The County is currently improving the sodium bisulfate feed system to prevent these violations.

The County is in the process of upgrading three pump stations upstream of the 63rd Avenue PS (53rd, Murray, and Barton). These projects will increase the storage upstream of the 63rd Avenue Pump Station, helping to reduce untreated combined sewer overflows. It may also tend to increase the volume treated at Alki. The County will need to review operational strategies at 63rd Avenue PS, the inlet regulator gate, and the West Seattle PS/Tunnel as these projects move forward.

Annual Limits - Between 2009 and 2012 there were 27 filling events and 19 discharge events, and the Alki facility met all annual permit limits for settleable solids and TSS removal. During this time period, the CSO facility prevented 67 million gallons of combined sewage from discharging into the Puget Sound.

5-Year Limits - The long-term average (i.e. permit cycle length) effluent discharge volume and number of events is limited to 108 million gallons (MG) and 29 discharge events, respectively. During the current permit cycle the Alki CSO treatment plant met these limits with an average annual discharge volume of 52 MG and average of 5 discharge events per year.

Carkeek CSO Treatment Plant

For the Carkeek CSO treatment plant, the previous permit placed effluent limits on TSS, fecal coliform, settleable solids, pH, and chlorine. Table 27 summarizes the violations and permit triggers that occurred from July 2009 through September 2013.

Table 27. Carkeek CSO Treatment Plant – Permit Violations

Date	Parameter	Statistical Base	Units	Value	Limit
1/1/2010	Fecal Coliform	Geometric Mean	#/100ml	755	400
12/1/2010	Chlorine, Total residual	Maximum	µg/L	1370	490
12/1/2010	Fecal Coliform	Geometric Mean	#/100ml	752	400
11/1/2012	Chlorine, Total residual	Maximum	µg/L	723	490
12/1/2012	pH, Daily Min	Minimum	Std Units	5.1	6

From 2009 to 2013, the Carkeek CSO plant exceeded fecal coliform and chlorine limits each twice. In 2011 King County retrofitted their sampling procedures and installed new auto-samplers that are capable of notifying the SCADA system when the sampling system fails. In 2013 the County upgraded the hypochlorite feed pump system with a pump upgrade, line flushing improvements, and a new hypochlorite flow meter.

Annual Limits - Between 2009 and 2012 there were 50 filling events and 23 discharge events, and the Carkeek facility met all annual permit limits for settleable solids and TSS removal. During this time period, the CSO facility prevented 17 million gallons of combined sewage from discharging into the Puget Sound.

5-Year Limits - The long-term average (i.e. permit cycle length) effluent discharge volume and number of events is limited to 46 million gallons (MG) and 10 discharge events, respectively. During the current permit cycle the Carkeek CSO treatment plant met these limits averaging 6 discharge events per year with an average annual discharge volume of 19 MG.

Elliott West CSO Treatment Plant

For the Elliott West CSO treatment plant, the previous permit placed effluent limits on TSS, fecal coliform, settleable solids, pH, and chlorine.

Table 28 summarizes the violations and permit triggers that occurred from July 2009 through September 2013.

Table 28. Elliott West CSO Treatment Plant – Permit Violations and Permit Triggers

Date	Parameter	Statistical Base	Units	Value	Limit
10/1/09	Fecal Coliform	Geometric Mean	#/100ml	5889	400
10/1/09	Settleable Solids	Maximum	mL/L	6	1.9
11/1/09	Settleable Solids	Maximum	mL/L	10	1.9
2009	TSS, Annual % removal	Annual Ave	%	41.6	>50
2009	Settleable Solids	Annual Ave	mL/L	2.3	0.3
1/1/10	Settleable Solids	Maximum	mL/L	9	1.9
4/1/10	Settleable Solids	Maximum	mL/L	2	1.9
9/1/10	Fecal Coliform	Geometric Mean	#/100ml	5,099	400
9/1/10	Settleable Solids	Maximum	mL/L	2	1.9
11/1/10	Fecal Coliform	Geometric Mean	#/100ml	2,439	400
11/1/10	Settleable Solids	Maximum	mL/L	2.5	1.9
12/1/10	Chlorine, Total residual	Maximum	µg/L	158	104
2010	Settleable Solids	Annual Ave	mL/L	1.5	0.3
3/1/11	Fecal Coliform	Geometric Mean	#/100ml	553	400
4/1/11	pH, Daily Min	Minimum	Std Units	5.5	6
4/1/11	Settleable Solids	Maximum	mL/L	4.5	1.9
5/1/11	Fecal Coliform	Geometric Mean	#/100ml	400,000	400
12/1/11	Chlorine, Total residual	Maximum	µg/L	259	104
12/1/11	Fecal Coliform	Geometric Mean	#/100ml	17000	400
2011	Settleable Solids	Annual Ave	mL/L	0.8	0.3
1/1/12	Chlorine, Total residual	Maximum	µg/L	231	104
1/1/12	Settleable Solids	Average	mL/L	1	0.3
7/1/12	Settleable Solids	Maximum	mL/L	5.5	1.9
10/1/12	pH, Daily Min	Minimum	Std Units	5.7	6
11/1/12	pH, Daily Min	Minimum	Std Units	5.7	6
12/1/12	Chlorine, Total residual	Maximum	µg/L	407	104
12/1/12	pH, Daily Min	Minimum	Std Units	5.76	6
12/1/12	Settleable Solids	Maximum	mL/L	3.7	1.9
2012	Settleable Solids	Annual Ave	mL/L	1.2	0.3
1/1/13	pH, Daily Min	Minimum	Std Units	5.9	6
3/1/13	Chlorine, Total residual	Maximum	µg/L	435	104
3/1/13	pH, Daily Min	Minimum	Std Units	5.95	6
3/1/13	Settleable Solids	Maximum	mL/L	2	1.9
4/1/13	pH, Daily Min	Minimum	Std Units	5.93	6
9/1/13	Chlorine, Total residual	Maximum	µg/L	860	104
9/1/13	Fecal Coliform	Geometric Mean	#/100ml	700	400

Several contributory factors affected permit compliance, including equipment performance (auto samplers, sampling pumps, dewatering pumps, flap gate failure, drain gate failure), poor mixing of chemicals, and hydraulic gradient issues that were causing surcharging at the dechlorination and outfall transition structures. The County has hired consultant engineers and implemented many projects to address the performance concerns.

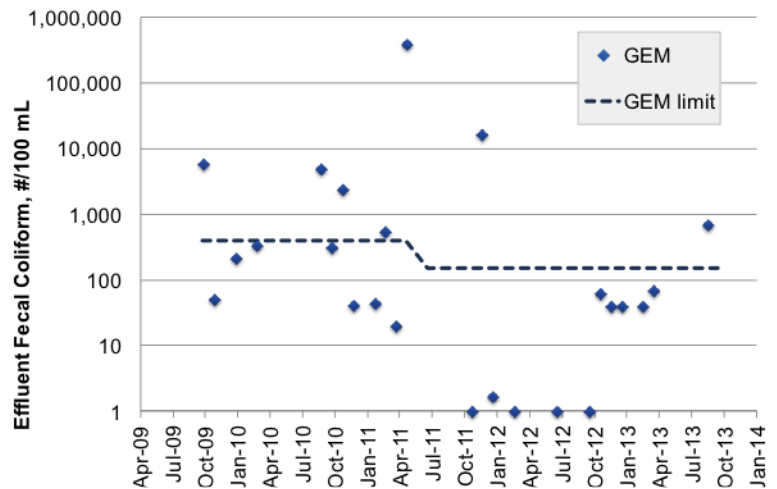

Figure 8. Fecal Coliform data for Elliott West CSO TP.

Fecal Coliform - As shown in Table 28 and Figure 8 the facility exceeded fecal coliform limits seven times between

October 2009 and October 2013. In 2011 the County rebuilt all three hypochlorite pumps, modified the hypo system plumbing, and started exercising the pumps on a regular schedule. In 2012 the County added new chemical flowmeters, increased chlorine contact time by moving the hypo injection point upstream, added an initial chlorine-demand analyzer, and converted the hypochlorite and bisulfite dosing control programs to compound loop controls. These improvements have resulted in somewhat lower fecal coliform levels and improved compliance, as can be seen in Figure 8.

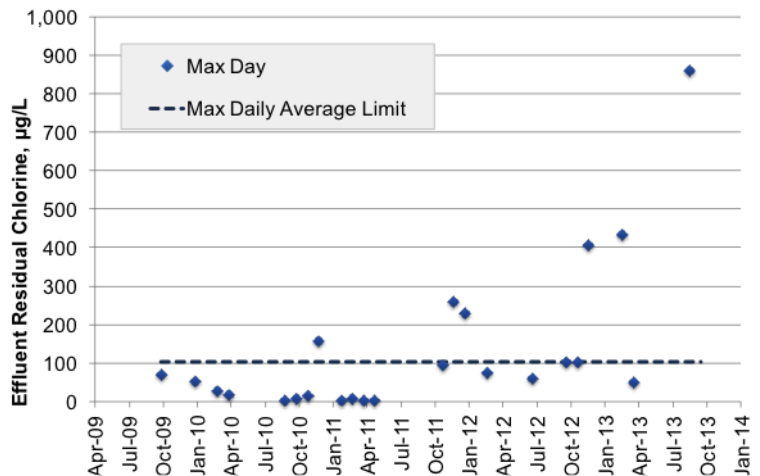

Figure 9. Residual chlorine data for Elliott West CSO TP.

Residual Chlorine - As shown in Table 28 and Figure 9 the facility exceeded chlorine limits six times between October 2009 and October 2013. To address this, in 2011 the County improved the sodium bisulfite system plumbing and initiated a standard procedure to manually flush the lines periodically to prevent freezing. The County also installed a pressure gauge to monitor for line constrictions. In 2012 the County converted the hypochlorite and bisulfite dosing controls as discussed above.

pH - Prior to 2011 pH fluctuated around 6.5. Since 2011, however, low pH has plagued this facility with the effluent frequently dropping below 6.0. These drops are likely a result of sodium bisulfate feed rates, but the situation is compounded by the lack of alkalinity in Seattle’s stormwater.

Settleable Solids - The facility also has difficulty meeting settleable solids limits. Table 28 shows 11 monthly exceedances and 4 annual exceedances. In 2013 the County repaired the discharge line drain gate through which marine water was entering the effluent line and sampling well. Automated tunnel flushing schedules implemented in 2013 will hopefully send more solids to West Point treatment plant after each CSO event. In addition, the County started turning on the tunnel's dewatering pumps sooner and leaving them on during a discharge event to enhance settled solids transfer to the West Point Treatment Plant. Also, the marine transition flap gate repair in December 2013 will keep marine water and solids out of the effluent tunnel and sampling well.

Additionally, the County installed a new effluent sample pump in 2010 and implemented procedures to make sure the pump is regularly inspected and tested. In February 2013 the County completed an effluent sampling improvement project and the County continues to provide annual sampling refresher training courses for operators.

The facility met the annual TSS removal requirement every year except 2009 in which the facility only achieved 42% removal.

Between 2009 and 2012 the Elliott West facility experienced 158 filling events and 45 discharge events. During this period, the CSO facility prevented 889 million gallons of combined sewage from discharging into Elliott Bay. However, the Elliott West CSO treatment plant continues its struggle to meet permit limits for fecal coliform, pH, chlorine, and settleable solids.

Henderson/MLK CSO Treatment Plant

For the Henderson/MLK CSO treatment plant, the previous permit placed effluent limits on TSS, fecal coliform, settleable solids, pH, and chlorine. Table 29 summarizes the violations and permit triggers that occurred from July 2009 through September 2013.

Table 29. Henderson/MLK CSO Treatment Plant – Permit Violations and Permit Triggers

Date	Parameter	Statistical Base	Units	Value	Limit	Violation
10/1/2010	Fecal Coliform	Geometric Mean	#/100ml	302,667	400	Numeric effluent violation
11/1/2012	Chlorine, Total residual	Maximum	µg/L	218	39	Numeric effluent violation

Annual Limits - Between 2009 and 2012 there were twelve filling events and four discharge events, and the Henderson/MLK facility met all annual permit limits for settleable solids and TSS removal. During this time period, the CSO facility prevented 24 million gallons of combined sewage from discharging into the Duwamish River.

G. State environmental policy act (SEPA) compliance

State law exempts the issuance, reissuance or modification of any wastewater discharge permit from the SEPA process as long as the permit contains conditions are no less stringent than federal and state rules and regulations (RCW 43.21C.0383). The exemption applies only to existing discharges, not to new discharges.

III. Proposed Permit Limits

Federal and state regulations require that effluent limits in an NPDES permit be either technology- or water quality-based.

- Technology-based limits are based upon the treatment methods available to treat specific pollutants. Technology-based limits are set by the EPA and published as a regulation, or Ecology develops the limit on a case-by-case basis (40 CFR 125.3, and chapter 173-220 WAC).
- Water quality-based limits are calculated so that the effluent will comply with the Surface Water Quality Standards (chapter 173-201A WAC), Ground Water Standards (chapter 173-200 WAC), Sediment Quality Standards (chapter 173-204 WAC), or the National Toxics Rule (40 CFR 131.36).
- Ecology must apply the most stringent of these limits to each parameter of concern. These limits are described below.

The limits in this permit reflect information received in the application and from supporting reports (engineering, hydrogeology, etc.). Ecology evaluated the permit application and determined the limits needed to comply with the rules adopted by the state of Washington. Ecology does not develop effluent limits for all reported pollutants. Some pollutants are not treatable at the concentrations reported, are not controllable at the source, are not listed in regulation, and do not have a reasonable potential to cause a water quality violation.

Ecology does not usually develop limits for pollutants not reported in the permit application but may be present in the discharge. The permit does not authorize discharge of the non-reported pollutants. During the five-year permit term, the facility's effluent discharge conditions may change from those conditions reported in the permit application. The facility must notify Ecology if significant changes occur in any constituent [40 CFR 122.42(a)]. Until Ecology modifies the permit to reflect additional discharge of pollutants, a permitted facility could be violating its permit.

A. Design criteria

Under WAC 173-220-150 (1)(g), flows and waste loadings must not exceed approved design criteria.

West Point WWTP

The design criteria for the West Point WWTP listed in Table 30 are taken from the 1991 Plans titled *West Point Treatment Plant Secondary Treatment Facilities, Liquids Stream*, prepared by CH₂M Hill, KCM, and others. Ecology erroneously put the wrong design criteria in the previous permit; the values were taken from the same document but for the 'saturation/future' loading levels instead of the actual 'design' levels. The proposed permit corrects this mistake by reducing the TSS and BOD₅ design loadings to those listed in Table 30.

Table 30. West Point WWTP Design Criteria

Parameter	Design Quantity
Monthly average flow (maximum month)	215 MGD
Average wet weather flow (non-storm)	133 MGD
Instantaneous peak flow (combined)	440 MGD
BOD ₅ influent loading (maximum month)	201,000 lbs/day
TSS influent loading (maximum month)	218,000 lbs/day

Permit Condition S10 authorizes CSO-related bypasses of the secondary treatment portion of the West Point WWTP when the instantaneous flows to the WWTP exceed 300 MGD as a result of precipitation. The wastewater that bypasses secondary treatment must receive solids and floatables removal, primary clarification, and disinfection. The final combined discharge must at all times meet the effluent limits listed in S1. EPA's 1994 CSO Control Policy allows for "CSO-related bypass" under certain conditions.

EPA's *CSO Guidance for Permit Writers* (EPA-832-B-95-08) states that a "CSO-related bypass" at the wastewater treatment plant can only occur if there is no feasible alternative and the no feasible alternatives analysis is part of the administrative record. The no feasible alternative requirement can be met if "the record shows that the secondary treatment system is properly operated and maintained, that the system has been designed to meet secondary limits for flows greater than the peak dry weather flow, plus an appropriate quantity of wet weather flow, and that it is either technically or financially infeasible to provide secondary treatment at the existing facilities for greater amounts of wet weather flow."

Ecology is confident the West Point WWTP is well operated and maintained based on monthly DMR and annual CSO reporting, frequent meetings, and inspections. As recommended by EPA's guidance, the West Point WWTP "meets secondary limits for flows greater than the peak dry weather flow plus an appropriate wet weather flow" (i.e., the facility provides secondary treatment to flows up to 300 MGD, which is greater than the maximum month wet weather flow of 215 MGD and meets secondary limits under all CSO conditions). When Metro designed the facility it was deemed infeasible to provide secondary treatment to peak wet weather flows from the combined system due to concerns that peak flows would wash out the secondary process.

King County submitted to Ecology a no feasibility alternatives analysis in 2009 (King County, 2009) per the CSO Control Policy requirements. As part of this permit development process Ecology reviewed this document again and concluded it still applies since there have been no major capacity changes at the facility. The document provides adequate justification to continue to authorize the CSO-related bypass for this permit cycle. Additionally, the collection system storage projects planned and in progress will likely result in fewer bypass events allowing the West Point facility to provide secondary treatment to more CSO flows than previously assessed in the 2009 analysis. Ecology will likely require an update to the no feasible alternatives analysis in the next permit which will be issued in 2019-2020.

Alki CSO Treatment Plant

Ecology obtained the design criteria the Alki facility, listed in Table 31, from the *Facilities Plan for Alki Transfer/CSO Project* prepared by HDR Engineering, Inc. and dated October 1992.

Table 31. Alki CSO Treatment Plant – Design Criteria

Parameter	Design
Peak storm water flow to treatment plant	65 MGD
TSS influent loading (average annual)	9,580 lbs/day

Carkeek CSO Treatment Plant

Ecology obtained the design criteria for the Carkeek Storage and CSO Treatment Plant, listed in Table 32, from the *Facility Plan for the Carkeek Transfer/CSO Facilities Project* prepared by Brown and Caldwell Consulting Engineers and dated December 1988.

Table 32. Carkeek CSO Treatment Plant – Design Criteria

Parameter	Design Quantity
Peak wet weather flow	20 MGD
TSS influent loading	5,100 lbs/day

EWCSO CSO Treatment Plant

Ecology obtained the design criteria for the EWCSO Satellite CSO Treatment Plant, listed in Table 33, from the *Denny Way/Lake Union CSO Control Facilities Plan*, dated July 1988.

Table 33. EWCSO Treatment Plant – Design Criteria

Parameter	Design
Tunnel Diameter	14' 8"
Tunnel Length	6,200'
Total Volume	7.2 MG

Henderson/MLK CSO Treatment Plant

Ecology obtained the design criteria for the Henderson/MLK CSO treatment plant, listed in Table 34, from the *Henderson/ML King CSO Control Facilities Plan* (approved March 5, 2002).

Table 34. Henderson/MLK CSO Treatment Plant – Design Criteria

Parameter	Design
Tunnel Diameter	14' 8"
Tunnel Length	3,100'
Total Volume	4 MG

B. Technology-based effluent limits

Federal and state regulations define technology-based effluent limits for municipal wastewater treatment plants. These effluent limits are given in 40 CFR Part 133 (federal) and in chapter 173-221 WAC (state). These regulations are performance standards that constitute all known, available, and reasonable methods of prevention, control, and treatment (AKART) for municipal wastewater.

The federal CSO Control Policy (59 FR 18688) also requires entities with Combined Sewer Overflows to implement “Nine Minimum Controls” as technology-based performance standards for CSO discharges. Nine Minimum Controls are discussed in more detail in Section V.G of this fact sheet.

West Point WWTP

The table below identifies technology-based limits for pH, fecal coliform, CBOD₅, and TSS, as listed in chapter 173-221 WAC for secondary wastewater treatment plants. Section III.F of this fact sheet describes the potential for water quality-based limits.

Table 35 Technology-based Limits (West Point WWTP)

Parameter	Average Monthly Limit	Average Weekly Limit
CBOD ₅	25 mg/L	40 mg/L
	In addition, the CBOD ₅ effluent concentration must not exceed: 15% of the average influent concentration from May-October, and 20% of the average influent concentration from November-April.	
TSS	30 mg/L	45 mg/L
	In addition, the TSS effluent concentration must not exceed: 15% of the average influent concentration from May-October, and 20% of the average influent concentration from November-April.	
Chlorine	0.5 mg/L	0.75 mg/L

Parameter	Monthly Geometric Mean Limit	Weekly Geometric Mean Limit
Fecal Coliform Bacteria	200 organisms/100 mL	400 organisms/100 mL

Parameter	Daily Minimum	Daily Maximum
pH	6.0 standard units	9.0 standard units

Ecology derived the technology-based monthly average limit for chlorine from standard operating practices. The Water Pollution Control Federation's *Chlorination of Wastewater* (1976) states that a properly designed and maintained wastewater treatment plant can achieve adequate disinfection if a 0.5 mg/L chlorine residual is maintained after fifteen minutes of contact time. See also Metcalf and Eddy, *Wastewater Engineering, Treatment, Disposal and Reuse*, Third Edition, 1991. A treatment plant that provides adequate chlorination contact time can meet the 0.5 mg/L chlorine limit on a monthly average basis. According to WAC 173-221-030(11)(b), the corresponding weekly average is 0.75 mg/L.

Technology-based mass limits are based on WAC 173-220-130(3)(b) and 173-221-030(11)(b). Ecology calculated the monthly and weekly average mass limits for CBOD₅ and Total Suspended Solids as follows:

$$\text{Mass Limit} = \text{CL} \times \text{DF} \times \text{CF}$$

where:

CL = Technology-based concentration limits listed in the above table

DF = Maximum Monthly Average Design flow (MGD)

CF = Conversion factor of 8.34

Table 36. Technology-based Mass Limits

Parameter	Concentration Limit (mg/L)	Mass Limit (lbs/day)
CBOD ₅ Monthly Average	25	44,800
CBOD ₅ Weekly Average	40	71,700
TSS Monthly Average	30	53,800
TSS Weekly Average	45	80,700

WAC 173-221-050 subsection (3) states that, “for domestic wastewater facilities which receive flows from combined sewer, Ecology shall decide on a case-by-case basis whether any attainable percent removal can be defined during wet weather.” The West Point WWTP receives a more dilute influent during wet weather due to a collection system that combines

both sanitary sewage and storm water. A dilute influent can make the 85% removal criteria for CBOD₅ and TSS difficult to achieve.

Calculations show that due to dilute influent at West Point during wet weather months, effluent TSS and CBOD₅ average monthly effluent concentrations would have to be 13% and 19% lower, on average, than their respective discharge limits (30/25 mg/L) 36 and 49 percent of the time, respectively, to meet the 85% removal requirement. Ecology calculated these values using average monthly influent concentrations over the past 5 years. According to the *EPA Permit Writer's Manual* (page 5-11), this criteria qualifies the West Point facility for less stringent percent removal requirements, consistent with 40 CFR 133.103(a). Ecology has assessed historical data and concluded that the West Point facility can consistently achieve 80% TSS and CBOD₅ removal during the wet weather months of November through April; the 85% removal requirement applies during the remaining months.

Federal CSO statute requires as one of the Nine Minimum Controls (9MC No. 4) that King County maximizes flows to the plant during the wet season in order to minimize CSO discharges. Ecology recognizes that increased flows and more dilute flows to the treatment plant over time may impact the achievable removal efficiency during wet weather conditions. In accordance with the EPA CSO guidance document, Ecology will re-evaluate wet season percent removal requirements each permit cycle based on recent plant performance data.

CSO Treatment Plants

The specific technology-based limits that apply to CSOs are the nine minimum controls. Also, CSO treatment plants must provide “primary treatment” which is defined in WAC 173-245-020(16) as “any process which removes at least 50% of the total suspended solids from the waste stream, and discharges less than 0.3 ml/L/hr of settleable solids.” Additionally, Ecology’s *Criteria for Sewage Works Design* clarifies that the 50% removal is to be assessed on an annual average basis.

Table 37. Technology & Guidance-based Limits for CSO Treatment Plants

Parameter	Limit
TSS ^a	50% removal, annual average
Settleable Solids ^a	0.3 ml/L/hr, annual average
Fecal Coliform Bacteria ^b	400 /100 mL

^a WAC 173-245-020(16)

^b Washington State Department of Ecology, *Criteria for Sewage Works Design*, December 1998, p C3-21.

Total Suspended Solids: The County’s four CSO treatment plants provide primary treatment which consists of sedimentation of solids and disinfection of the effluent prior to discharge. In order to comply with Washington State regulation, the limit for all CSO treatment plants is based on overall percent removal of total suspended solids of 50% or greater. The overall percent removal on an annual basis includes the removal achieved at the CSO treatment plant and that achieved at the West Point WWTP.

Settleable Solids: Ecology evaluates compliance of the CSO treatment plant effluent with the 0.3 ml/l/hr of settleable solids limit based on a yearly average due to the intermittent and highly variable operation of the CSOs. Ecology removed the settleable solids event maximum limit of 1.9 ml/l/hr because there is no basis in regulation for an event maximum settleable solids limit.

Fecal Coliform: Ecology's technical guidance document (*Criteria for Sewage Works Design*, C3-3.3.8) states that an appropriate performance criterion for end-of-the-pipe CSO treatment for fecal coliform is 400 cfu/100 mL. Ecology believes this criterion is appropriate and achievable for the Alki, Carkeek, and Henderson/MLK facilities based on data collected between September 2009 and September 2013. During this time, Alki met the fecal coliform criteria 13 of the 16 months in which discharges occurred, the Carkeek facility met the criteria 9 of the 11 months in which discharges occurred, and the Henderson/MLK facility met the criteria 3 of the 4 months in which discharges occurred. Additionally, King County has recently upgraded equipment and improved SOPs at these facilities to improve future performance.

For Elliott West, the technical guidance-based limit is applied as Ecology views this limit as more appropriate and protective of water quality than the previous final limit. For further discussion, refer to sub-section F below and Appendix F.

C. Surface water quality-based effluent limits

The Washington State surface water quality standards (chapter 173-201A WAC) are designed to protect existing water quality and preserve the beneficial uses of Washington's surface waters. Waste discharge permits must include conditions that ensure the discharge will meet the surface water quality standards (WAC 173-201A-510). Water quality-based effluent limits may be based on an individual waste load allocation or on a waste load allocation developed during a basin wide total maximum daily load study (TMDL).

Numerical criteria for the protection of aquatic life and recreation

Numerical water quality criteria are listed in the water quality standards for surface waters (chapter 173-201A WAC). They specify the maximum levels of pollutants allowed in receiving water to protect aquatic life and recreation in and on the water. Ecology uses numerical criteria along with chemical and physical data for the wastewater and receiving water to derive the effluent limits in the discharge permit. When surface water quality-based limits are more stringent or potentially more stringent than technology-based limits, the discharge must meet the water quality-based limits.

Federal regulation (40 CFR 122.45(c)) requires Ecology to express effluent limits for metals in the form of total recoverable. However, the 1992 revision of the Washington Water Quality Standards express metals criteria in the dissolved form. Ecology therefore uses metal translators to predict the dissolved to total recoverable fraction in the receiving water. For marine waters, these translators are provided in WAC 173-201A-240(3). However, Ecology's Permit Writer's Manual recommends using the fraction of dissolved to total recoverable measured in the receiving water during the critical condition if data is available. King County provided both the dissolved and total recoverable fractions of several metals in their *2013 Receiving Water Study* and Ecology chose to use these ratios where applicable, as summarized in Table 38.

Numerical criteria for the protection of human health

The U.S. EPA has published 91 numeric water quality criteria for the protection of human health that are applicable to dischargers in Washington State (EPA, 1992). These criteria are designed to protect humans from exposure to pollutants linked to cancer and other diseases, based on consuming fish and shellfish and drinking contaminated surface waters. The water quality standards also include radionuclide criteria to protect humans from the effects of radioactive substances.

Table 38. Metal Translators Used in Reasonable Potential Analyses

Metal	Ecology Translators ^a		Wt Point & Carkeek	Alki	Elliott West	Henderson / MLK ^b
	Acute	Chronic				
Arsenic	1.000	1.000	1.000	0.980	1.000	1.000
Cadmium	0.994	0.994	0.980	0.950	0.960	0.994
Chromium	0.993	0.993	0.960	0.993	0.993	0.993
Copper	0.830	0.830	0.790	0.920	0.790	0.830
Lead	0.951	0.951	0.951	0.951	0.951	0.951
Mercury	0.850	n/a	0.850	0.850	0.850	0.850
Nickel	0.990	0.990	1.000	0.950	0.970	0.990
Silver	0.850	n/a	0.850	0.850	0.850	0.850
Zinc	0.946	0.946	0.946	0.946	0.946	0.946

^a From WAC 173-201A-240(3)

^b Used Ecology's marine translators for all metals for this outfall because critical condition was not fully characterized with receiving water data (e.g., unclear how partitioning is affected by salinity fluctuations).

Narrative criteria

Narrative water quality criteria (e.g., WAC 173-201A-240(1); 2006) limit the toxic, radioactive, or other deleterious material concentrations that the facility may discharge to levels below those which have the potential to:

- Adversely affect designated water uses.
- Cause acute or chronic toxicity to biota.
- Impair aesthetic values.
- Adversely affect human health.

Narrative criteria protect the specific designated uses of all fresh waters (WAC 173-201A-200, 2006) and of all marine waters (WAC 173-201A-210, 2006) in the state of Washington.

Antidegradation

Description--The purpose of Washington's Antidegradation Policy (WAC 173-201A-300-330; 2006) is to:

- Restore and maintain the highest possible quality of the surface waters of Washington.
- Describe situations under which water quality may be lowered from its current condition.
- Apply to human activities that are likely to have an impact on the water quality of surface water.
- Ensure that all human activities likely to contribute to a lowering of water quality, at a minimum, apply all known, available, and reasonable methods of prevention, control, and treatment (AKART).
- Apply three tiers of protection (described below) for surface waters of the state.

Tier I ensures existing and designated uses are maintained and protected and applies to all waters and all sources of pollutions. Tier II ensures that waters of a higher quality than the criteria assigned are not degraded unless such lowering of water quality is necessary and in the overriding public interest. Tier II applies only to a specific list of polluting activities. Tier

III prevents the degradation of waters formally listed as "outstanding resource waters," and applies to all sources of pollution.

A facility must prepare a Tier II analysis when all three of the following conditions are met:

- The facility is planning a new or expanded action.
- Ecology regulates or authorizes the action.
- The action has the potential to cause measurable degradation to existing water quality at the edge of a chronic mixing zone.

Facility Specific Requirements--The facilities covered by this permit must meet Tier I requirements.

- Dischargers must maintain and protect existing and designated uses. Ecology must not allow any degradation that will interfere with, or become injurious to, existing or designated uses, except as provided for in chapter 173-201A WAC.

Ecology's analysis described in this section of the fact sheet demonstrates that the proposed permit conditions will protect existing and designated uses of the receiving water.

Combined Sewer Overflows

Chapter 173-245 WAC requires that "all CSO sites shall achieve and at least maintain the greatest reasonable reduction, and neither cause violations of applicable water quality standards, nor restrictions to the characteristic uses of the receiving water, nor accumulation of deposits which: (a) exceed sediment criteria or standards; or (b) have an adverse biological effect." The *greatest reasonable reduction* means control of each CSO outfall such that an average of no more than one untreated discharge may occur per year. Ecology includes specific conditions in the proposed permit to ensure that the Permittee continues to make progress towards meeting water quality goals for each CSO outfall in its system. Section V of this fact sheet contains more detailed information on these CSO requirements.

Mixing zones

A mixing zone is the defined area in the receiving water surrounding the discharge port(s), where wastewater mixes with receiving water. Within mixing zones the pollutant concentrations may exceed water quality numeric standards, so long as the discharge doesn't interfere with designated uses of the receiving water body (for example, recreation, water supply, and aquatic life and wildlife habitat, etc.) The pollutant concentrations outside of the mixing zones must meet water quality numeric standards.

State and federal rules allow mixing zones because the concentrations and effects of most pollutants diminish rapidly after discharge, due to dilution. Ecology defines mixing zone sizes to limit the amount of time any exposure to the end-of-pipe discharge could harm water quality, plants, or fish.

The state's water quality standards allow Ecology to authorize mixing zones for the facility's permitted wastewater discharges only if those discharges already receive all known, available, and reasonable methods of prevention, control, and treatment (AKART). Mixing zones typically require compliance with water quality criteria within a specified distance from the point of discharge and must not use more than 25% of the available width of the water body for dilution [WAC 173-201A-400 (7)(a)(ii-iii)].

Ecology uses modeling to estimate the amount of mixing within the mixing zone. Through modeling Ecology determines the potential for violating the water quality standards at the edge of the mixing zone and derives any necessary effluent limits. Steady-state models are the most frequently used tools for conducting mixing zone analyses. Ecology chooses values for each effluent and for receiving water variables that correspond to the time period when the most critical condition is likely to occur (see Ecology's *Permit Writer's Manual*). Each critical condition parameter, by itself, has a low probability of occurrence and the resulting dilution factor is conservative. The term "reasonable worst-case" applies to these values.

The mixing zone analysis produces a numerical value called a dilution factor (DF). A dilution factor represents the amount of mixing of effluent and receiving water that occurs at the boundary of the mixing zone. For example, a dilution factor of 10 means the effluent is 10% and the receiving water is 90% of the total volume of water at the boundary of the mixing zone. Ecology uses dilution factors with the water quality criteria to calculate reasonable potentials and effluent limits. Water quality standards include both aquatic life-based criteria and human health-based criteria. The former are applied at both the acute and chronic mixing zone boundaries; the latter are applied only at the chronic boundary. The concentration of pollutants at the boundaries of any of these mixing zones may not exceed the numerical criteria for that zone.

Most of the aquatic life *acute* criteria are based on the assumption that organisms are not exposed to that concentration for more than one hour and more often than one exposure in three years. Most of the aquatic life *chronic* criteria are based on the assumption that organisms are not exposed to that concentration for more than four consecutive days and more often than once in three years.

The two types of human health-based water quality criteria distinguish between those pollutants linked to non-cancer effects (non-carcinogenic) and those linked to cancer effects (carcinogenic). The human health-based water quality criteria incorporate several exposure and risk assumptions. These assumptions include:

- A 70-year lifetime of daily exposures.
- An ingestion rate for fish or shellfish measured in kg/day.
- An ingestion rate of two liters/day for drinking water.
- A one-in-one-million cancer risk for carcinogenic chemicals.

This permit authorizes acute mixing zones for each outfall, surrounded by chronic mixing zones around each point of discharge (WAC 173-201A-400). The water quality standards impose certain conditions before allowing dischargers a mixing zone:

1. *Ecology must specify both the allowed size and location in a permit.*

The proposed permit specifies the sizes and locations of the allowed mixing zones (as specified below).

2. *The facility must fully apply "all known, available, and reasonable methods of prevention, control and treatment" (AKART) to its discharges.*

Ecology has determined that the treatment provided meets the requirements of AKART.

3. *Ecology must consider critical discharge conditions.*

Surface water quality-based limits are derived for the waterbody's critical condition (the receiving water and waste discharge condition with the highest potential for adverse impact

on the aquatic biota, human health, and existing or designated waterbody uses). The critical discharge condition is often pollutant-specific or waterbody-specific.

Critical discharge conditions are those conditions that result in reduced dilution or increased effect of the pollutant. Factors affecting dilution include the depth of water, the density stratification in the water column, the currents, and the rate of discharge. Density stratification is determined by the salinity and temperature of the receiving water. Temperatures are warmer in the surface waters in summer. Therefore, density stratification is generally greatest during the summer months. Density stratification affects how far up in the water column a freshwater plume may rise. The rate of mixing is greatest when an effluent is rising. The effluent stops rising when the mixed effluent is the same density as the surrounding water. After the effluent stops rising, the rate of mixing is much more gradual. Water depth can affect dilution when a plume might rise to the surface when there is little or no stratification. Ecology uses the water depth at mean lower low water (MLLW) for marine waters. Ecology's *Permit Writer's Manual* describes additional guidance on criteria/design conditions for determining dilution factors. The manual can be obtained from Ecology's website at:

<http://www.ecy.wa.gov/biblio/92109.html>.

West Point WWTP

King County modeled the West Point WWTP discharge using the critical conditions listed in Table 39.

Table 39. West Point WWTP - Critical Conditions Used to Model the Discharge.

Critical Condition	Value
Water depth at MLLW	230 feet
Number of diffuser ports	200
Diffuser port diameter	4.5" - 5.75"
Acute Condition:	
Density profile with a difference of 0.1 sigma-t units between 246 feet and the surface (Dec)	
10 th or 90 th percentile current speeds	0.428-0.49 m/sec
Maximum daily effluent flow	404 MGD
Chronic and Human Health Conditions:	
Density profile with a difference of 1.5 sigma-t units between 246 feet and the surface (July)	
50th percentile current speeds for chronic and human health mixing zones	0.252-0.264 m/sec
Maximum ave monthly effluent flow for chronic and human health non-carcinogen	87 MGD
Annual average flow for human health carcinogen (design average annual flow)	142 MGD

Source: King County's 2013 Effluent Dilution Modeling Report for the West Point WWTP Outfall

CSO Treatment Plants

King County derived the chronic and acute dilution factors for the intermittent CSO discharges using effluent flow rates calculated according to guidance in Ecology's *Permit Writer's Manual, Appendix 6*. Table 40 summarizes the very conservative methodology King County used to assess treatment plant flows for these intermittent discharges.

Table 40. CSO discharge flows used in dilution calculations

Acute	Equivalent 24-hour Average Flow = total event volume divided by total event duration. King County used the event with the highest equivalent 24-hr flow for each assessment.
Chronic	Equivalent Monthly Average Flow = Total volume of all discharge events in a month divided by the total hours of discharge in that month. King County used the highest equivalent monthly average flow from the previous 3 years of operation for each assessment.

King County modeled the Alki, Carkeek, Elliott West, and Henderson/MLK CSO treatment plant discharges using the critical conditions listed in Table 41 through Table 44.

Table 41. Alki CSO TP: Critical Conditions Used to Model the Discharge

Critical Condition	Value
Water depth at MLLW	143 feet
Number of diffuser ports	8
Diffuser port diameter	12"
Acute Condition:	
Density profile with a difference of 0.7 sigma-t units between 147 feet and the surface	
10 th or 90 th percentile current speeds	0.05 m/sec
Maximum equivalent 24-hour flow	52 MGD
Chronic Condition:	
Density profile with a difference of 0.04 sigma-t units between 147 feet and the surface	
50th percentile current speeds	0.16 m/sec
Maximum equivalent monthly average effluent flow	33 MGD

Source: King County's 2013 Effluent Dilution Modeling Report for the Alki CSO TP Outfall

Table 42. Carkeek CSO TP: Critical Conditions Used to Model the Discharge

Critical Condition	Value
Water depth at MLLW	195 feet
Number of diffuser ports	13
Diffuser port diameter	5.5 - 10"
Acute Condition:	
Density profile with a difference of 0.25 sigma-t units between 195 feet and the surface	
10 th or 90 th percentile current speeds	0.02 & 0.15 m/sec
Maximum equivalent 24-hour flow	9.5 MGD
Chronic Condition:	
Density profile with a difference of 0.5 sigma-t units between 195 feet and the surface	
50th percentile current speeds	0.05 m/sec
Maximum equivalent monthly average effluent flow	9.3 MGD

Source: King County's 2013 Effluent Dilution Modeling Report for the Carkeek CSO TP Outfall

Table 43. Elliott West CSO TP: Critical Conditions Used to Model the Discharge

Critical Condition	Value
Water depth at MLLW	60 feet
Number of diffuser ports	1
Diffuser port diameter	90"
Acute Condition:	
Density profile with a difference of 0.9 sigma-t units between 60 feet and the surface	
10 th or 90 th percentile current speeds	0.025 & 0.1 m/sec
Maximum equivalent 24-hour flow	67 MGD
Chronic Condition:	
Density profile with a difference of 1.4 sigma-t units between 60 feet and the surface	
50th percentile current speeds	0.05 m/sec
Maximum equivalent monthly average effluent flow	58 MGD

Source: King County's 2013 Effluent Dilution Modeling Report for the Elliott West CSO TP Outfall

Table 44. Henderson/MLK CSO TP: Critical Conditions Used to Model the Discharge

Critical Condition	Value
Number of diffuser ports	1
Port diameter	84"
50 th percentile current speed for chronic mixing zone	0.21 m/s
10 th & 90 th percentile current speeds for acute mixing zone	0.078 & 0.39 m/s
Maximum average monthly effluent flow for chronic = used chronic facility design flow	25 MGD
Maximum daily flow for acute mixing zone – used acute facility design flow	77 MGD

Source: King County's 2013 Effluent Dilution Modeling Report for the Henderson/MLK CSO TP Outfall. Ambient data at critical conditions in the vicinity of the outfall were taken from the Henderson/MLK Pre-design Report.

4. *Supporting information must clearly indicate the mixing zone would not:*

- Have a reasonable potential to cause the loss of sensitive or important habitat.
- Substantially interfere with the existing or characteristic uses.
- Result in damage to the ecosystem.
- Adversely affect public health.

Ecology established Washington State water quality criteria for toxic chemicals using EPA criteria. EPA developed the criteria using toxicity tests with numerous organisms and set the criteria to generally protect the species tested and to fully protect all commercially and recreationally important species.

EPA sets acute criteria for toxic chemicals assuming organisms are exposed to the pollutant at the criteria concentration for one hour. They set chronic standards assuming organisms are exposed to the pollutant at the criteria concentration for four days.

The discharge plume does not impact drifting and non-strong swimming organisms because they cannot stay in the plume close to the outfall long enough to be affected. Strong swimming fish could maintain a position within the plume, but they can also avoid the discharge by swimming away. Mixing zones generally do not affect benthic organisms (bottom dwellers) because the buoyant plume rises in the water column. Ecology has additionally determined that the effluent will not exceed 33 degrees C for more than two seconds after discharge; and that the temperature of the water will not create lethal conditions or blockages to fish migration.

Ecology evaluates the cumulative toxicity of an effluent by testing the discharge with whole effluent toxicity (WET) testing.

Ecology reviewed the above information, the specific information on the characteristics of the discharge, the receiving water characteristics, and the discharge location. Based on this review, Ecology concluded that the discharge does not have a reasonable potential to cause the loss of sensitive or important habitat, substantially interfere with existing or characteristics uses, result in damage to the ecosystem, or adversely affect public health if the permit limits are met.

5. *The discharge/receiving water mixture must not exceed water quality criteria outside the boundary of a mixing zone.*

Ecology conducted a reasonable potential analysis, using procedures established by the EPA and by Ecology, for each pollutant and concluded the discharge/receiving water mixture will not violate water quality criteria outside the boundary of the mixing zone if permit limits are met.

6. *The size of the mixing zone and the concentrations of the pollutants must be minimized.*

At any given time, the effluent plume uses only a portion of the acute and chronic mixing zone, which minimizes the volume of water involved in mixing. Because tidal currents change direction, the plume orientation within the mixing zone changes. The plume mixes as it rises through the water column therefore much of the receiving water volume at lower depths in the mixing zone is not mixed with discharge. Similarly, because the discharge may stop rising at some depth due to density stratification, waters above that depth will not mix with the discharge. Ecology determined it is impractical to specify in the permit the actual, much more limited volume in which the dilution occurs as the plume rises and moves with the current.

Ecology minimizes the size of mixing zones by requiring dischargers to install diffusers when they are appropriate to the discharge and the receiving waterbody. When a diffuser is installed, the discharge is more completely mixed with the receiving water in a shorter time. Ecology also minimizes the size of the mixing zone (in the form of the dilution factor) using design criteria with a low probability of occurrence. For example, Ecology uses the expected 95th percentile pollutant concentration, the 90th percentile background concentration, the centerline dilution factor, and the lowest flow occurring once in every ten years to perform the reasonable potential analysis.

Because of the above reasons, Ecology has effectively minimized the sizes of the mixing zones authorized in the proposed permit.

7. *Maximum size of mixing zone.*

The authorized mixing zones do not exceed the maximum size restrictions. Mixing zone dimensions are depicted in Figure 10 through Figure 14.

8. *Acute mixing zone.*

- *The discharge/receiving water mixture must comply with acute criteria as near to the point of discharge as practicably attainable.*

For each outfall, Ecology determined whether the acute criteria would be met at 10% of the distance or volume fraction of the chronic mixing zone.

- *The pollutant concentration, duration, and frequency of exposure to the discharge will not create a barrier to migration or translocation of indigenous organisms to a degree that has the potential to cause damage to the ecosystem.*

As described above, the toxicity of any pollutant depends upon the exposure, the pollutant concentration, and the time the organism is exposed to that concentration. Authorizing a limited acute mixing zone for this discharge assures that it will not create a barrier to migration. The effluent from this discharge will rise as it enters the receiving water, assuring that the rising effluent will not cause translocation of indigenous organisms near the point of discharge (below the rising effluent).

- *Comply with size restrictions.*

The mixing zone authorized for this discharge complies with the size restrictions published in chapter 173-201A WAC.

9. *Overlap of mixing zones.*

The mixing zones authorized in this permit do not overlap other mixing zones.

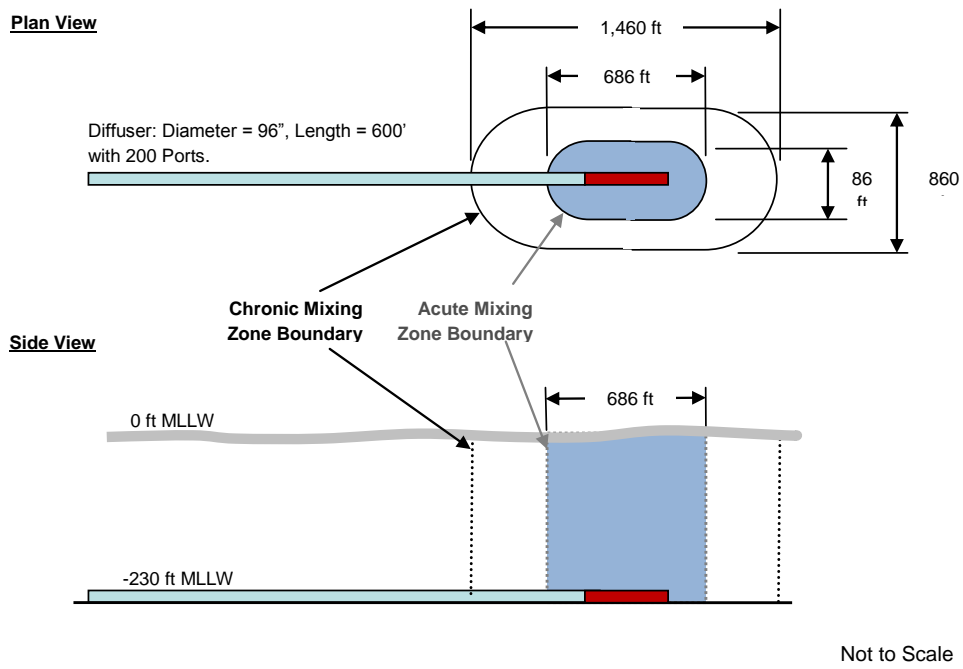

Figure 10. West Point's WWTP's Mixing Zone

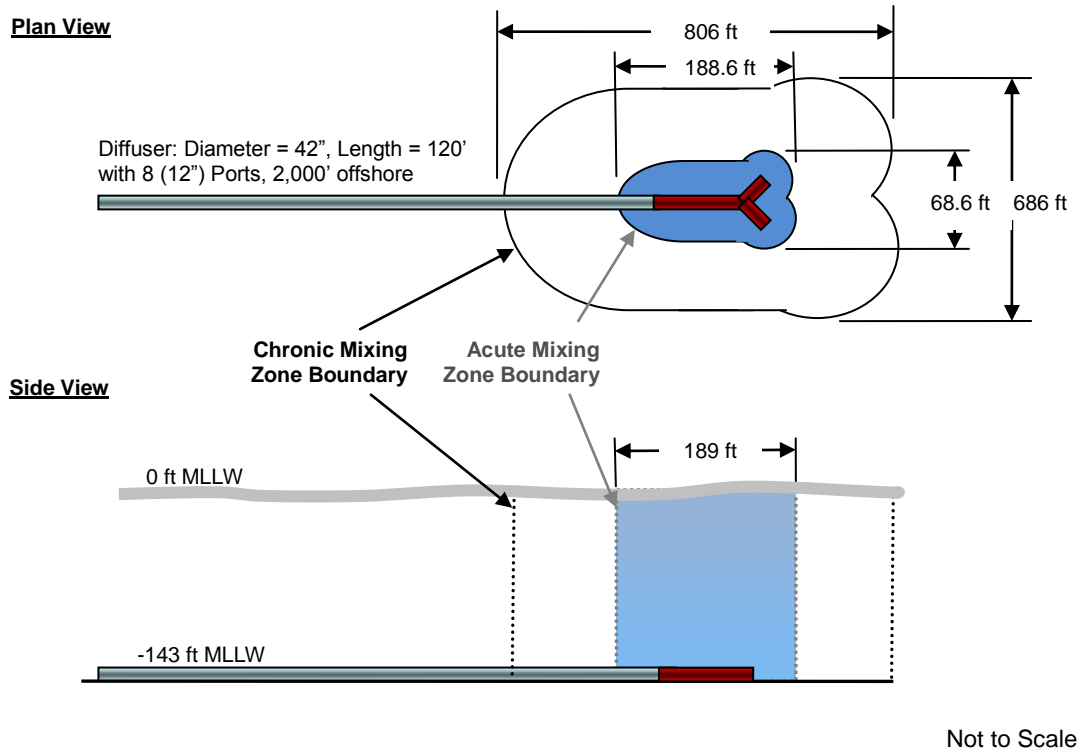
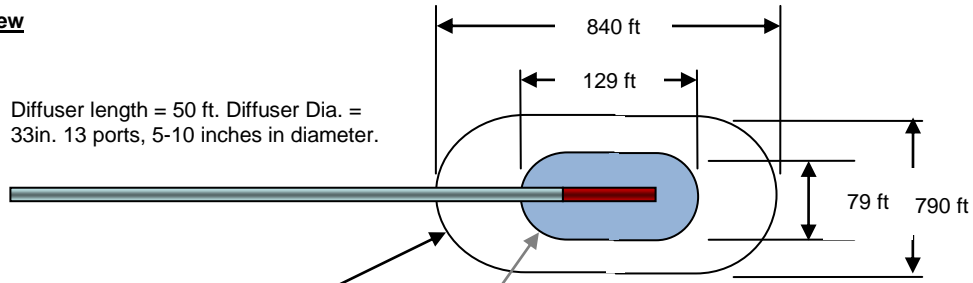
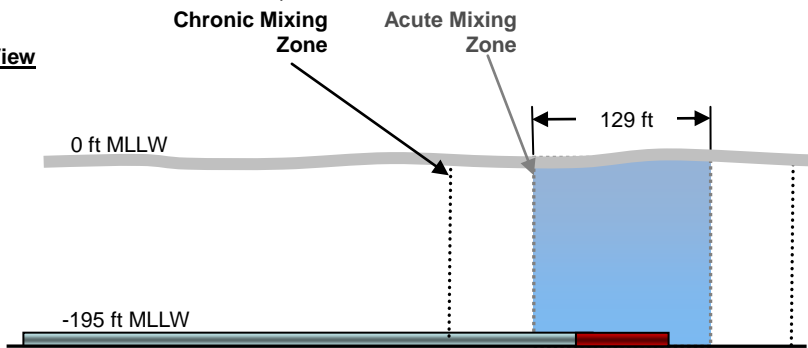

Figure 11. Alki's Mixing Zone

Plan View



Side View



Not to Scale

Figure 12. Carkeek's Mixing Zone Zone

Plan View

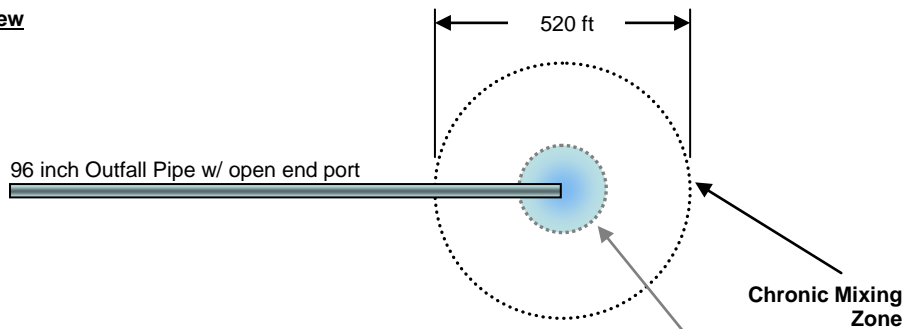

Side View

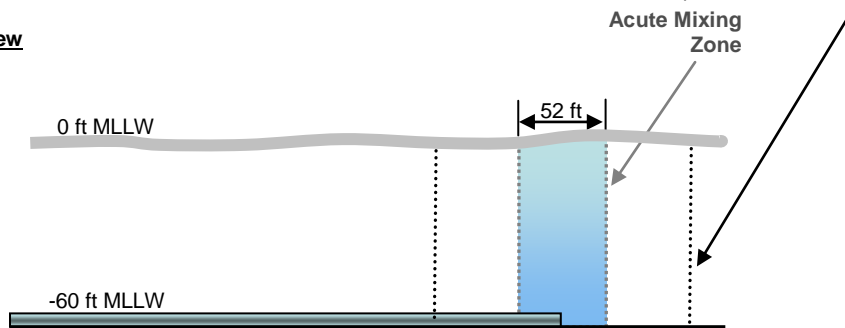

Figure 13. Elliott West Mixing Zone

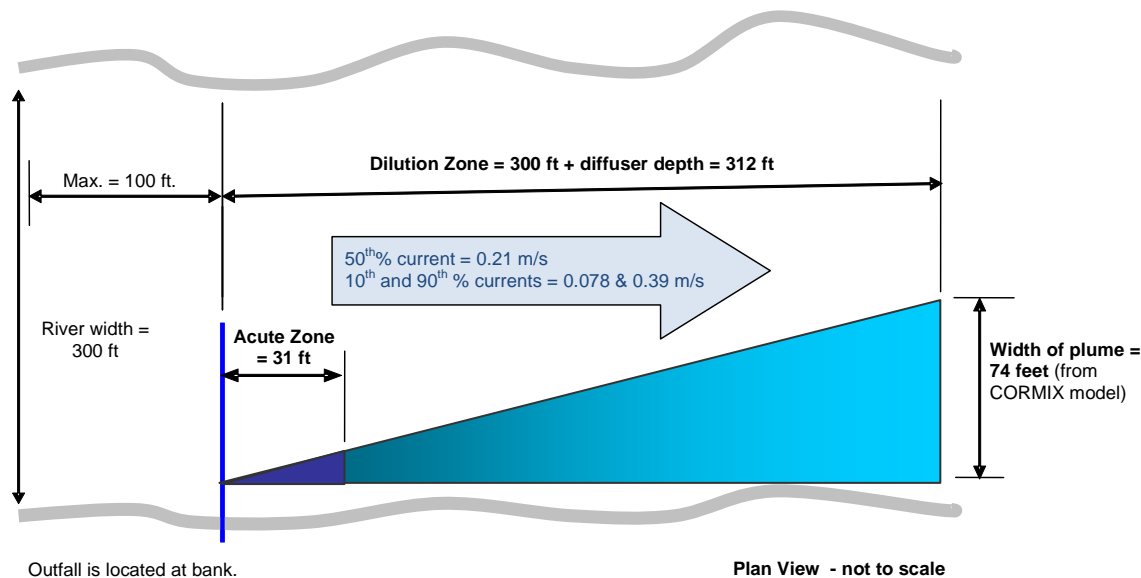

Figure 14. Henderson/MLK Mixing Zones

D. Designated uses and surface water quality criteria

Applicable designated uses and surface water quality criteria are defined in chapter 173-201A WAC. In addition, the U.S. EPA set human health criteria for toxic pollutants (EPA 1992). The descriptions and tables below summarize the criteria applicable to the receiving water's designated uses.

Puget Sound Discharges:

Aquatic life uses are designated using the following general categories. All indigenous fish and non-fish aquatic species must be protected in waters of the state.

- a. Extraordinary quality salmonid and other fish migration, rearing, and spawning; clam, oyster, and mussel rearing and spawning; crustaceans and other shellfish (crabs, shrimp, crayfish, scallops, etc.) rearing and spawning.
- b. Excellent quality salmonid and other fish migration, rearing, and spawning; clam, oyster, and mussel rearing and spawning; crustaceans and other shellfish (crabs, shrimp, crayfish, scallops, etc.) rearing and spawning.
- c. Good quality salmonid migration and rearing; other fish migration, rearing, and spawning; clam, oyster, and mussel rearing and spawning; crustaceans and other shellfish (crabs, shrimp, crayfish, scallops, etc.) rearing and spawning.
- d. Fair quality salmonid and other fish migration.

The West Point WWTP, Alki CSO TP, and the Carkeek CSO TP discharge to *Extraordinary Marine* waters. The *Aquatic Life Uses* and the associated criteria for this receiving water are identified in Table 45.

Table 45. Marine Aquatic Life Uses and Criteria - West Point WWTP, Alki, and Carkeek

Extraordinary Quality	
Temperature Criteria – Highest 1D MAX	13°C (55.4°F)
Dissolved Oxygen Criteria – Lowest 1-Day Min	7.0 mg/L
Turbidity Criteria	<ul style="list-style-type: none"> • 5 NTU over background when the background is 50 NTU or less; or • A 10 percent increase in turbidity when the background turbidity is more than 50 NTU.
pH Criteria	pH must be within the range of 7.0 to 8.5 with a human-caused variation within the above range of less than 0.2 units.

The Elliott West CSO TP discharges to *Excellent* Marine waters. The Aquatic Life Uses and the associated criteria for this receiving water are identified in Table 46.

Table 46. Marine Aquatic Life Uses and Associated Criteria - Elliott West

Excellent Quality	
Temperature Criteria – Highest 1D MAX	16°C (60.8°F)
Dissolved Oxygen Criteria – Lowest 1-Day Min	6.0 mg/L
Turbidity Criteria	<ul style="list-style-type: none"> • 5 NTU over background when the background is 50 NTU or less; or • A 10 percent increase in turbidity when the background turbidity is more than 50 NTU.
pH Criteria	pH must be within the range of 7.0 to 8.5 with a human-caused variation within the above range of less than 0.5 units.

To protect *shellfish harvesting* in the receiving waters around the West Point WWTP, Alki, Carkeek, and Denny/Elliott West CSO treatment plants, fecal coliform organism levels must not exceed a geometric mean value of 14 colonies/100 mL and not have more than 10 percent of all samples (or any single sample when less than ten sample points exist) obtained for calculating the geometric mean value exceeding 43 colonies/100 mL.

Recreational uses include primary contact and secondary contact recreation. The recreational use for receiving waters around the West Point WWTP, Alki, Carkeek, and Elliott West CSO treatment plant outfalls is primary contact as identified in Table 47.

Miscellaneous marine water uses include wildlife habitat, harvesting, commerce and navigation, boating, and aesthetics.

Table 47. Recreational Uses - West Point WWTP, Alki, Carkeek, and Elliott West

Recreational Use	Criteria
Primary Contact Recreation	Fecal coliform organism levels must not exceed a geometric mean value of 14 colonies/100 mL, with not more than 10 percent of all samples (or any single sample when less than ten sample points exist) obtained for calculating the geometric mean value exceeding 43 colonies /100 mL.

Duwamish River Discharge (Henderson/MLK):

The Henderson/MLK CSO TP discharges to the Duwamish River. Ecology designated this portion of the river with an Aquatic Life Use of rearing and migration only and a Recreation Use of secondary contact. However, salinity data from King County’s *2012 Receiving Water Study* and other sources indicates that the receiving water in the vicinity of the Henderson/MLK outfall is tidally influenced and meets the salinity requirements of WAC

173-201a-260. This means that the marine criteria apply to this waterbody for all parameters except for fecal coliform. The criteria for Excellent Aquatic Life Uses are listed in Table 48.

Table 48. Receiving Water Criteria Comparison for Henderson/MLK

Aquatic Life Uses	Marine Criteria: Excellent
Temperature	16°C (60.8°F) – Highest 1D MAX
Dissolved Oxygen	6.0 mg/L – Lowest 1-Day Minimum
Turbidity	<ul style="list-style-type: none"> • 5 NTU over background when the background is 50 NTU or less; or • A 10 percent increase in turbidity when the background turbidity is more than 50 NTU.
pH	pH must be within the range of 7.0 to 8.5 with a human-caused variation within the above range of less than 0.5 units.
Recreational Use	Freshwater Criteria: Secondary Contact
Fecal Coliform	Fecal coliform organism levels must not exceed a geometric mean value of 200 colonies/100 mL, with not more than 10 percent of all samples (or any single sample when less than ten sample points exist) obtained for calculating the geometric mean value exceeding 400 colonies /100 mL.

For fecal coliform, WAC 173-201a-260 states that freshwater criteria must be applied *when ninety-five percent of the salinity values are less than ten parts per thousand* (based on vertically averaged daily maximum salinity values). Ecology placed freshwater criteria in the proposed permit, consistent with the existing permit. This decision is supported by the fact that this treatment facility only discharges once or twice each year and during very large storm events when the river flow is likely high from significant storm runoff. Under these circumstances the salinity component of the receiving water is most likely quite insignificant. As discharges from the facility increase with future CSO correction projects, Ecology may require future ambient salinity testing to support this decision.

The *miscellaneous freshwater uses* for the Henderson/MLK receiving water are wildlife habitat, harvesting, commerce and navigation, boating, and aesthetics.

E. Water quality and sediment impairments

Central Puget Sound, South Puget Sound, and Elliott Bay are listed on Ecology's 2012 303(d) list as impaired for fecal coliform in the vicinities of the West Point WWTP, Alki, Carkeek, and Elliott West CSO outfalls. Ecology is not currently conducting a fecal coliform Total Maximum Daily Load (TMDL) analysis for these areas. Instead, Ecology is focusing on the South Puget Sound Dissolved Oxygen study; this study should be finalized in the next few years.

The Duwamish River is listed as impaired for high pH in the vicinity of the Henderson/MLK CSO outfall. Downstream of the outfall in the lower Duwamish, sediments and fish tissue are listed as impaired for a wide range of contaminants due to decades of industrial activity and run off from industrial areas. These contaminants include PCBs (polychlorinated biphenyls), PAHs (polycyclic aromatic hydrocarbons), chlorinated dioxins & furans, arsenic and other metals, pesticides and phthalates. EPA is leading the sediment contamination investigation for the Lower Duwamish Waterway site with support from Ecology. In 2001, EPA added the Lower Duwamish Waterway site to the Superfund National Priorities List; Ecology added the site to the Washington Hazardous Sites list in 2002. More information on the Lower Duwamish Waterway Superfund site can be found on EPA's web page: Lower Duwamish Waterway site. More information on the sediment contamination clean-up can be found on

the following sites: Duwamish River Cleanup Coalition (<http://www.duwamishcleanup.org>) the Lower Duwamish Work Group (<http://www.ldwg.org>), and Ecology's LDW webpage (http://www.ecy.wa.gov/programs/tcp/sites_brochure/lower_duwamish/lower_duwamish_hp.html).

In 1992 Ecology issued an ammonia-nitrogen TMDL in the Green/Duwamish system that identified a zero ammonia-nitrogen wasteload allocation for King County's Renton South WWTP (except during emergencies and planned short-term maintenance). King County responded to this TMDL by relocating their South Plant WWTP outfall to the Puget Sound.

F. Evaluation of surface water quality-based effluent limits for numeric criteria

Pollutants in an effluent may affect the aquatic environment near the point of discharge (near-field) or at a considerable distance from the point of discharge (far-field). Toxic pollutants, for example, are near-field pollutants; their adverse effects diminish rapidly with mixing in the receiving water. Conversely, a pollutant such as biochemical oxygen demand (BOD) is a far-field pollutant whose adverse effect occurs away from the discharge even after dilution has occurred. Thus, the method of calculating surface water quality-based effluent limits varies with the point at which the pollutant has its maximum effect.

With technology-based controls (AKART), predicted pollutant concentrations in the discharge exceed water quality criteria. Ecology therefore authorizes a mixing zone in accordance with the geometric configuration, flow restriction, and other restrictions imposed on mixing zones by chapter 173-201A WAC.

Estuarine Mixing Zones (West Point WWTP, Alki, Carkeek, and Elliott West)

Chronic --WAC 173-201A-400(7)(b) specifies that mixing zones must not extend in any horizontal direction from the discharge ports for a distance greater than 200 feet plus the depth of water over the discharge ports as measured during MLLW. The mixing zone extends from the top of the discharge ports to the water surface.

Acute - WAC 173-201A-400(8)(b) specifies that in estuarine waters a zone where acute criteria may be exceeded must not extend beyond 10% of the distance established for the chronic zone.

West Point WWTP

The diffuser at outfall 001 is 600 feet long with 200 ports spaced equally on alternating sides with diameters ranging between 4.5 and 5.75-inches. The mean lower low water (MLLW) diffuser depth is 230 feet. Ecology obtained this information from King County's 2013 *Effluent Dilution Modeling for West Point Treatment Plant Outfall Report*.

The horizontal distance of the chronic mixing zone is 430 feet from any discharge port. The acute mixing zone extends 43 feet in any direction from any discharge port.

Alki CSO

The Alki outfall ends in a multi-port diffuser at a depth of 43.6m (143 ft) MLLW. The diffuser is 120 feet long with eight 12-inch diameter diffuser ports. The first six ports are directed to alternating sides of the outfall. The two end ports formed a 'Y' at the end of the diffuser. Ecology obtained this information from King County's 2013 *Effluent Dilution Modeling-Alki CSO Treatment Facility Marine Outfall Report*.

The horizontal distance of the chronic mixing zone is 340 feet. The acute mixing zone extends 34 feet in any direction from any discharge port.

Carkeek CSO Outfall

The Carkeek outfall ends in a multi-port diffuser at a depth of 59.5m (195 ft) MLLW. The diffuser is 50 feet long with 13 diffuser ports varying between 5.5-inches and 10.0-inches in diameter. The ports are equally spaced on alternating sides. A port diameter of 6.57 inches corresponds to the average port area. Ecology obtained this information from King County's *2013 Effluent Dilution Modeling-Carkeek CSO Treatment Facility Marine Outfall Report*.

The horizontal distance of the chronic mixing zone is 395 feet from any discharge port. The acute mixing zone extends 39.5 feet in any direction from any discharge port.

Elliott West CSO Outfall

The Elliott West outfall ends with a single 90 inch diameter port at a depth of 60 ft MLLW, approximately 490 ft offshore. Several years ago King County removed a duckbill valve from the end of the port to reduce back pressure caused by the valve. Ecology obtained this information from King County's *2013 Effluent Dilution Modeling-Elliott West CSO Treatment Facility Marine Outfall Report*.

The horizontal distance of the chronic mixing zone is 260 feet from any discharge port. The acute mixing zone extends 26 feet in any direction from any discharge port.

Freshwater Mixing Zone (Henderson/MLK)

While the marine water quality criteria apply for the Henderson/MLK discharge, Ecology applied the freshwater mixing zone sizing criteria to the Henderson/MLK outfall because WAC 173-201A-400(8)(a) states that riverine size criteria "may also be applied to estuaries having flow characteristics resembling rivers".

Chronic --WAC 173-201A-400(7)(a) specifies that mixing zones must not extend in a downstream direction from the discharge ports for a distance greater than 300 feet plus the depth of water over the discharge ports or extend upstream for a distance of over 100 feet, not utilize greater than 25% of the flow, and not occupy greater than 25% of the width of the water body.

Acute --WAC 173-201A-400(8)(a) specifies that in rivers and streams a zone where acute toxics criteria may be exceeded must not extend beyond 10% of the distance towards the upstream and downstream boundaries of the chronic zone, not use greater than 2.5% of the flow and not occupy greater than 25% of the width of the water body.

The Henderson/MLK effluent discharges through an 84-inch, single-port pipe, located at the Norfolk outfall. The Norfolk outfall is located on the north bank of the Duwamish River approximately at river km 10.5. The 84-inch diameter outfall approaches the river bank at a 90-degree angle to the river flow and is flush with the bank. There is a flap gate on the end of the pipe that is assumed to be completely open during discharge events.

For the Henderson/MLK CSO treatment plant outfall, the chronic mixing zone is 312 feet long (downstream) and 74 feet wide. The acute mixing zone is 31.2 feet long. Both mixing zones extend from the river bottom to the top of the water surface. The dilution factors are based on dilution at the downstream distance or where the plume width reaches 25% of the river width, whichever is more conservative.

Dilution Factors

King County calculated the dilution factors that occur within these zones at the critical conditions using Visual Plumes (UM3 and RSB model components) for all outfalls except

Henderson/MLK, for which the County used the CORMIX model. Table 49 compares the proposed dilution factors to the dilution factors in the current permit.

Ecology reviewed the County's data, dilution factors, and modeling in November 2013. Ecology verified that the County used conservative assumptions and provided rigorous modeling to obtain dilution factors. There are differences between the dilution factors used in the previous permit and the dilution factors used in the proposed permit as described below. Ecology revised the dilution factors because calculations were performed with 1) updated receiving water current and density data, and 2) updated effluent flow data obtained during the previous permit cycle. Ecology considers the dilution factors in the proposed permit to be more up-to-date and representative than the factors in the previous permit. Ecology notes that three of the dilution factors increased and four dilution factors decreased from the previous permit.

Table 49. Comparison of Dilution Factors

	Chronic Dilution Factor		Acute Dilution Factor		Human Health, Carcinogen		Human Health, Non-carcinogen	
	Current Permit	Proposed Permit	Current Permit	Proposed Permit	Current Permit	Proposed Permit	Current Permit	Proposed Permit
West Point WWTP	181	188	28	28	330	324	330	324
Alki CSO	61	99	17.5	20	*	*	*	*
Carkeek CSO	146	104	93	75	*	*	*	*
Elliott West CSO	11	9.7	7.8	8.4	*	*	*	*
Henderson/MLK	10.3	10.3	1.9	1.9	*	*	*	*

* Human Health dilution factors not assessed for CSO treatment plants. Ecology used chronic dilution factors for reasonable potential assessments.

Changes in the proposed dilution factors can be explained as follows:

1. *West Point WWTP* – Updated effluent and receiving water data resulted in a larger chronic dilution factor compared to the previous analysis. In the recent analysis, receiving water density data show that the receiving water is most stratified in July. This stratification results in reduced plume mixing and therefore lower dilution factors than those calculated during winter months. As a result, the maximum average monthly flow used in the dilution calculation decreased from 204 MGD in the previous analysis to 87 MGD (max flow during July in past 3 years). This in combination with the updated receiving water density profile resulted in a slightly higher dilution factor. No change is proposed for the acute dilution factor.
2. *Alki CSO* – Updated effluent and receiving water data resulted in larger chronic and acute dilution factors compared to the previous analysis.
3. *Carkeek CSO* – Updated effluent and receiving water data resulted in reduced chronic and acute dilution factors compared to the previous analysis.
4. *Elliott West CSO* – Updated effluent and receiving water data resulted in a reduced chronic and a slightly larger acute dilution factor compared to the previous analysis.
5. *Henderson/MLK CSO* – No dilution factors changes are proposed.

Ecology assessed the impacts of the treatment plant discharges on receiving water dissolved oxygen deficiency, pH, fecal coliform, turbidity, toxics (ammonia, chlorine, metals, and other priority pollutants), and temperature using the dilution factors listed in Table 49. The

following tables describe this assessment for each treatment plant. The derivation of any surface water quality-based limits also takes into account the variability of pollutant concentrations in both the effluent and the receiving water.

West Point Wastewater Treatment Plant	
Dissolved Oxygen - BOD ₅ and Ammonia Effects	<p>Natural decomposition of organic material in wastewater effluent impacts dissolved oxygen (DO) in the receiving water at distances far outside of the regulated mixing zone. The 5-day Biochemical Oxygen Demand (BOD₅) of an effluent sample indicates the amount of biodegradable material in the wastewater and estimates the magnitude of oxygen consumption the wastewater will generate in the receiving water. The amount of ammonia-based nitrogen in the wastewater also provides an indication of oxygen demand potential in the receiving water.</p> <p>Ecology modeled the impact of BOD₅ on the receiving water using a simple mixing model and an estimated oxidation rate at critical conditions (see Appendix F). Based on King County's receiving water study, dissolved oxygen in the vicinity of the outfall is frequently below the water quality criteria of 7 mg/L. King County's data shows the 10th percentile dissolved oxygen value as 6.1 mg/L. Under critical conditions, assuming a typical technology-based weekly average effluent limit of 45 mg/L, the mixing model shows that dissolved oxygen decreases by 0.07 mg/L at the chronic mixing zone.</p> <p>Ecology is in the process of modeling the impacts of nutrient discharges from wastewater treatment plants and non-point sources on dissolved oxygen levels in the south Puget Sound. Ecology plans to publish the results of this study in the next several years. The results may impact nutrient control in future permits but since the study is not yet complete, the proposed permit does not include nutrient limits. The proposed permit requires nutrient monitoring to provide data to better inform future permitting decisions.</p>
pH	Compliance with the technology-based limits of 6.0 to 9.0 will assure compliance with the water quality standards of surface waters because of the high buffering capacity of marine water. For calculations see Appendix F.
Fecal Coliform	Ecology modeled receiving water fecal coliform by simple mixing analysis and ambient data from King County's <i>2013 Receiving Water Characterization Study</i> . With a dilution factor of 188, a technology-based limit of 400/100 mL, and an ambient fecal concentration of 4/100 mL, Ecology calculated a fecal coliform concentration at the edge of the mixing zone boundary of 6/100 mL, well below the water quality standard of 14 colonies/100 mL (for primary contact recreation). Therefore, the proposed permit includes the technology-based effluent limits for fecal coliform bacteria.
Turbidity	Ecology evaluated the impact of turbidity based on the range of total suspended solids in the effluent and turbidity of the receiving water. Ecology expects no violations of the turbidity criteria outside the designated mixing zone provided the facility meets its technology-based total suspended solids permit limits.
Toxics	<p>Federal regulations (40 CFR 122.44) require Ecology to place limits in NPDES permits on toxic chemicals in an effluent whenever there is a reasonable potential for those chemicals to exceed the surface water quality criteria. Ecology does not exempt facilities with technology-based effluent limits from meeting the surface water quality standards.</p> <p>The following toxic pollutants were detected in West Point WWTP's discharge: ammonia, 1,4 dichlorobenzene, 2,4 dichlorophenol, 2,4 dimethylphenol, antimony, arsenic, bis(2-ethylhexyl)phthalate, cadmium, chromium (hex), copper, cyanide, diethylphthalate, lead, manganese, methylene chloride, mercury, nickel, phenol, pyrene, selenium, silver, thallium, toluene, zinc, chlorine. Ecology conducted a reasonable potential analysis (see Appendix F) on these parameters to assess whether effluent limits would be required.</p>

West Point Wastewater Treatment Plant	
	<p>King County provided ambient data in their 2013 receiving water study and the following parameters were detected in the receiving water: ammonia, arsenic, cadmium, chromium (hex), copper, lead, mercury, nickel, silver, and zinc. Ecology used the 90% concentrations for these pollutants in the reasonable potential analysis and assumed zero for ambient concentrations if data was not available.</p> <p>Ecology determined that none of the toxics detected in the effluent pose a reasonable potential to exceed the water quality criteria at the critical condition using procedures given in EPA, 1991. Ecology's determination assumes that this facility meets the other effluent limits of this permit.</p> <p>Ecology derived effluent limits for chlorine using methods from EPA, 1991 as shown in Appendix F. Ecology derived the new limits based on the state water quality standards of 13 µg/L for acute and 7.5 µg/L for chronic along with an acute dilution factor of 28 and a chronic dilution factor of 188. The proposed effluent limits are 139 µg/L (average monthly limit) and 364 µg/L (maximum daily limit).</p>
Temperature	<p>The state temperature standards (WAC 173-201A-200-210 and 600-612) include multiple elements: annual summer maximum threshold criteria, supplemental spawning and rearing season criteria, incremental warming restrictions, and protections against acute effects. Ecology evaluates each criterion independently to determine reasonable potential and derive permit limits.</p> <p><i>Annual summer maximum and supplementary spawning/rearing criteria</i> - Each water body has an annual maximum temperature criterion [WAC 173-201A-200(1)(c), 210(1)(c), and Table 602]. These threshold criteria protect specific categories of aquatic life by controlling the effect of human actions on summer temperatures.</p> <p>Some waters have an additional threshold criterion to protect the spawning and incubation of salmonids (9°C for char and 13°C for salmon and trout) [WAC 173-201A-602, Table 602]. These criteria apply during specific date-windows.</p> <p>The threshold criteria apply at the edge of the chronic mixing zone. Criteria for most fresh waters are expressed as the highest 7-Day average of daily maximum temperature (7-DADMax). The 7-DADMax temperature is the arithmetic average of seven consecutive measures of daily maximum temperatures. Criteria for marine waters and some fresh waters are expressed as the highest 1-Day annual maximum temperature (1-DMax).</p> <p><i>Incremental warming criteria</i> - The water quality standards limit the amount of warming human sources can cause under specific situations [WAC 173-201A-200(1)(c)(i)-(ii), 210(1)(c)(i)-(ii)]. The incremental warming criteria apply at the edge of the chronic mixing zone.</p> <p>At locations and times when background temperatures are cooler than the assigned threshold criterion, point sources are permitted to warm the water by only a defined increment. These increments are permitted only to the extent doing so does not cause temperatures to exceed either the annual maximum or supplemental spawning criteria.</p> <p>At locations and times when a threshold criterion is being exceeded due to natural conditions, all human sources, considered cumulatively, must not warm the water more than 0.3°C above the naturally warm condition.</p> <p>When Ecology has not yet completed a TMDL, our policy allows each point source to warm water at the edge of the chronic mixing zone by 0.3°C. This is true regardless of the background temperature and even if doing so would cause the temperature at the edge of a standard mixing zone to exceed the numeric threshold criteria. Allowing a 0.3°C warming for each point source is reasonable and protective where the dilution factor is based on 25% or less of the critical flow. This is because the fully mixed effect on temperature will only be a fraction of the 0.3°C cumulative allowance (0.075°C or less) for all human sources combined.</p> <p><i>Protections for temperature acute effects</i> –</p> <p>Instantaneous lethality to passing fish: The upper 99th percentile daily maximum effluent temperature must not exceed 33°C, unless a dilution analysis indicates ambient</p>

West Point Wastewater Treatment Plant	
	<p>temperatures will not exceed 33°C two seconds after discharge.</p> <p>General lethality and migration blockage: Measurable (0.3°C) increases in temperature at the edge of a chronic mixing zone are not allowed when the receiving water temperature exceeds either a 1DMax of 23°C or a 7DADMax of 22°C.</p> <p>Lethality to incubating fish: Human actions must not cause a measurable (0.3°C) warming above 17.5°C at locations where eggs are incubating.</p> <p>Reasonable Potential Analysis for Annual summer maximum and incremental warming criteria: Ecology calculated the reasonable potential for the discharge to exceed the annual summer maximum and the incremental warming criteria at the edge of the chronic mixing zone during critical conditions (see Appendix F). No reasonable potential exists to exceed the temperature criterion where:</p> $(\text{Criterion} + 0.3) > [\text{Criterion} + (\text{Teffluent}_{95} - \text{Criterion})/\text{DF}]$ $(13 + 0.3) > (13 + (21.0 - 13.0)/188)$ $13.3 > 13.04$ <p>Therefore, the proposed permit does not include a temperature limit.</p> <p>King County reported temperature data with their monthly discharge monitoring reports; Ecology used the 95th percentile of the 1DADmax value reported. Using a dilution factor of 188 and maximum daily temperature of 14.0°C for the receiving water, the predicted maximum daily temperature inside the dilution zone is 14.04°C. Thus, under the worst case scenario, the effluent discharge from this facility results in warming of the ambient temperature by 0.04°C, which is less than the allowable warming temperature of 0.3°C.</p>

Alki CSO Treatment Plant	
Dissolved Oxygen - BOD ₅	Calculations show there is no reasonable potential for the Alki CSO treatment plant to violate DO water quality standards. For calculations see Appendix F.
pH	Compliance with the technology-based limits of 6.0 to 9.0 will assure compliance with the water quality standards of surface waters because of the high buffering capacity of marine water. For calculations see Appendix F.
Fecal Coliform	<p>With the dilution factor of 99, the guidance-based limit of 400/100mL, and an ambient fecal concentration of 1/100 mL (from KC's 2013 receiving water study), Ecology calculated a fecal coliform concentration at the edge of the mixing zone boundary of 5/100 mL, which is below the water quality standard of 14 colonies/100 mL (see Appendix F). Therefore, the proposed permit includes the technology-based effluent limit for fecal coliform bacteria, on a monthly basis, since it is protective of water quality and more stringent than the water-quality based limit.</p> <p>For CSO treatment plants that have technology/guidance-based limits for fecal coliform, the calculation method only includes discharge days. Non-discharge days are not included in the calculation, as the technology/guidance-based limit applies only when discharges are occurring with the reasoning that the plant is capable of achieving the technology/guidance limit on any given day.</p>
Toxics	<p>The following toxic pollutants are present in the Alki CSO treatment plant's discharge: ammonia, antimony, arsenic, bis(2-ethylhexyl)phthalate, butylbenzyl phthalate, cadmium, chlorine, chloroform, chromium (hex), copper, diethylphthalate, lead, mercury, nickel, silver, and zinc. Ecology conducted a reasonable potential analysis (see Appendix F) on these parameters to assess whether effluent limits would be required.</p> <p>King County provided ambient data in their 2013 receiving water study and the following parameters were detected in the receiving water: ammonia, antimony, arsenic, cadmium, chlorine, chromium (hex), copper, lead, mercury, nickel, silver, and zinc. Ecology used the 90% concentrations for these pollutants in the reasonable potential analysis and assumed zero for ambient concentrations if data was not available.</p>

Alki CSO Treatment Plant	
	<p>Ecology determined that none of the toxics detected in the effluent, except chlorine, pose a reasonable potential to exceed the water quality criteria at the critical condition using procedures given in EPA, 1991. Ecology's determination assumes that this facility meets the other effluent limits of this permit.</p> <p>Ecology derived effluent limits for the toxic pollutant chlorine using methods from EPA, 1991 as shown in Appendix F. The calculated maximum daily water-quality-based limit for chlorine based on the revised dilution factors is 260 µg/L. The previous permit included a water-quality based limit of 234 µg/L based the dilution factor in the 2009 permit. The anti-backsliding provision under the federal regulations [CFR 122.44(l)] requires that the chlorine limit be based on the more stringent limit established in the previous permit since it has been shown to be technologically achievable.</p>
Temperature	<p>The County was not required to collect temperature data for this facility so Ecology used West Point data for this assessment. Using the 95th percentile of West Point's 1DADmax (21.0°C) and a dilution factor of 99, no reasonable potential exists to exceed the temperature criterion where:</p> $0.3 > (T_{\text{effluent}95} - T_{\text{ambient}90})/DF$ $0.3 > (21.0 - 12.7)/99$ $0.3 > 0.08$ <p>Under these assumptions, the effluent discharge from this facility results in warming of the ambient temperature by 0.08°C, which is less than the allowable warming temperature of 0.3°C. Therefore, the proposed permit does not include a temperature limit.</p>

Carkeek CSO Treatment Plant	
Dissolved Oxygen -BOD ₅	Calculations show there is no reasonable potential for the Carkeek CSO treatment plant to violate DO water quality standards. For calculations see Appendix F.
pH	Compliance with the technology-based limits of 6.0 to 9.0 will assure compliance with the water quality standards of surface waters because of the high buffering capacity of marine water. For calculations see Appendix F.
Fecal Coliform	<p>With the dilution factor of 104, the guidance-based limit of 400/100mL, and an ambient fecal concentration of 4/100 mL (obtained from King County's 2013 ambient monitoring report), Ecology calculated a fecal coliform concentration at the edge of the mixing zone boundary of 8/100mL, which is below the water quality standard of 14 colonies/100 mL (see Appendix F). Therefore, the proposed permit includes the guidance-based effluent limit for fecal coliform bacteria, on a monthly basis, since it is protective of water quality and more stringent than the water quality-based limit.</p> <p>For CSO treatment plants that have technology/guidance-based limits for fecal coliform, the calculation method only includes discharge days. Non-discharge days are not included in the calculation, as the technology/guidance-based limit applies only when discharges are occurring with the reasoning that the plant is capable of achieving the technology/guidance limit on any given day.</p>
Toxics	<p>The following toxic pollutants were detected in Carkeek CSO treatment plant's discharge: ammonia, antimony, arsenic, benzo(b)fluoranthene, benzo(k)fluoranthene, bis(2-ethylhexyl)phthalate, butylbenzyl phthalate, cadmium, chloroform, chromium (hex), copper, 2-4 dichlorophenol, diethylphthalate, di-n-butyl phthalate, lead, mercury, nickel, silver, toluene, zinc, and chlorine. Ecology conducted a reasonable potential analysis (see Appendix F) on these parameters to assess whether effluent limits would be required.</p> <p>King County provided ambient data in their 2013 receiving water study and the following parameters were detected in the receiving water: ammonia, arsenic, cadmium, chromium (hex), copper, lead, mercury, nickel, silver, and zinc. Ecology used the 90% concentrations for these pollutants in the reasonable potential analysis and assumed zero for ambient concentrations if data was not available.</p>

Carkeek CSO Treatment Plant	
	<p>Ecology determined that none of the toxics detected in the effluent, except chlorine, pose a reasonable potential to exceed the water quality criteria at the critical condition using procedures given in EPA, 1991. Ecology's determination assumes that this facility meets the other effluent limits of this permit.</p> <p>Ecology derived effluent limits for the toxic pollutant chlorine, determined to have a reasonable potential to cause a violation of the water quality standards. Ecology calculated effluent limits using methods from EPA, 1991 as shown in Appendix F. The calculated maximum daily water-quality-based limit for chlorine based on the revised mixing zone is 975 µg/L. The technology-based maximum daily limit for chlorine is more stringent than the water-quality-based limit at 750 µg/L. The previous permit included a water-quality based limit of 490 µg/L based on the dilution factor in the 2004 permit. The anti-backsliding provision under the federal regulations [CFR 122.44(l)] requires that the more stringent limit established in the previous permit be applied since it has been shown to be technologically achievable.</p>
Temperature	<p>The County was not required to collect temperature data for this facility so Ecology used West Point data for this assessment. Using the 95th percentile of West Point's 1DADmax (21.0°C) and a dilution factor of 104, no reasonable potential exists to exceed the temperature criterion where:</p> $0.3 > (T_{\text{effluent}95} - T_{\text{ambient}90})/DF$ $0.3 > (21.0 - 14.0)/104$ $0.3 > 0.07$ <p>Under these assumptions, the effluent discharge from this facility results in warming of the ambient temperature by 0.07°C, which is less than the allowable warming temperature of 0.3°C. Therefore, the proposed permit does not include a temperature limit.</p>

Elliott West CSO Treatment Plant	
Dissolved Oxygen - BOD ₅	<p>Preliminary calculations show there could be a reasonable potential for the effluent from the Elliott West CSO treatment plant to violate DO water quality standards (see Appendix F). Ecology could not make a reliable assessment due to very limited DO data for this facility. The proposed permit requires additional DO monitoring so Ecology can better assess the impacts of BOD on dissolved oxygen in the receiving water at the next permit issuance. The Elliott West CSO treatment plant was originally designed for CSO treatment and not designed to remove BOD. Ecology is addressing the impact of effluent nutrients on Puget Sound DO in the ongoing South Puget Sound DO Study.</p>
pH	<p>Compliance with the technology-based limits of 6.0 to 9.0 will assure compliance with the water quality standards of surface waters because of the high buffering capacity of marine water. For calculations see Appendix F.</p>
Fecal Coliform	<p>With the chronic dilution factor of 9.7, the guidance-based limit of 400/100mL, an ambient fecal concentration of 2/100 mL (obtained from King County's 2013 ambient monitoring report), and an assumption that the facility discharges three times each month for a period of 24 hours, Ecology calculated a monthly geometric mean for fecal coliform at the edge of the mixing zone boundary of 2.4/100mL. This easily meets the water quality standard of 14 colonies/100 mL (see Appendix F for calculations). Therefore, the proposed permit includes the guidance-based effluent limit for fecal coliform bacteria, on a monthly basis, since it is protective of water quality and more stringent than the water quality-based limit. The previous permit included this same guidance-based limit for an interim period followed by a less stringent WQ-based limit that included non-discharge days in the calculation. Ecology now believes this guidance-based limit is more appropriate and more protective of the water quality in Elliott Bay and therefore proposes this limit in the proposed permit.</p> <p>For CSO treatment plants that have technology/guidance-based limits for fecal coliform, the calculation method only includes discharge days. Non-discharge days are not included in the calculation, as the technology/guidance-based limit applies only</p>

Elliott West CSO Treatment Plant	
	<p>when discharges are occurring with the reasoning that the plant is capable of achieving the technology/guidance limit on any given day. Compliance with this limit must be calculated using the geometric mean of all fecal coliform samples taken during each calendar month a discharge occurs.</p>
<p>Toxics</p>	<p>The following toxic pollutants were detected in Elliott West CSO treatment plant's discharge: ammonia, antimony, arsenic, bis(2-ethylhexyl)phthalate, butylbenzyl phthalate, cadmium, chloroform, chromium (hex), copper, 1-4 dichlorobenzene, dichlorobromomethane, 2-4 dichlorophenol, diethylphthalate, dimethylphthalate, fluoranthene, lead, mercury, nickel, pentachlorophenol, pyrene, selenium, silver, thallium, toluene, zinc, chlorine, and cyanide (weak acid dissociable).</p> <p>King County provided ambient data in their 2013 receiving water study and the following parameters were detected in the receiving water: ammonia, arsenic, cadmium, chromium (hex), copper, lead, mercury, nickel, silver, and zinc. Ecology used the 90% concentrations for these pollutants in the reasonable potential analysis and assumed zero for ambient concentrations if data was not available.</p> <p>Ecology conducted a reasonable potential analysis (see Appendix F) on these parameters to determine if they pose a reasonable potential to exceed the water quality criteria at the critical condition using procedures given in EPA, 1991. Ecology determined that the only toxics detected in the effluent that pose a reasonable potential are chlorine, copper, and cyanide. Ecology's determination assumes that this facility meets the other effluent limits of the permit.</p> <p>Ecology derived an effluent limit for chlorine using methods from EPA, 1991 as shown in Appendix F. The proposed chlorine effluent limit is based on the revised dilution factors King County calculated using recent effluent flow data. The resultant maximum daily effluent limit for chlorine is 109 µg/L.</p> <p>Calculations also showed a reasonable potential for copper. The copper levels in the Elliott West effluent are consistently five to six times higher than those from other King County outfalls. The County suspects this is a sampling anomaly caused by contamination within the sampling collection system. The proposed permit requires additional copper monitoring using an improved sampling technique, along with a study to evaluate copper reduction strategies including source control options, copper removal at the facility, and improved outfall mixing.</p> <p>Cyanide (weak acid dissociable) concentrations in the effluent were below detection (<5 µg/L) for 8 out of 11 samples; the three detected samples measured 7.3 (estimate), 11.8, and 19.3 µg/L. The proposed permit requires additional monitoring to better assess cyanide concentrations in the Elliott West effluent.</p>
<p>Temperature</p>	<p>The County was not required to collect temperature data for this facility so Ecology used West Point data for this assessment. Using the 95th percentile of West Point's 1DADmax (21.0°C) and a dilution factor of 9, no reasonable potential exists to exceed the temperature criterion where:</p> $\begin{aligned} \text{Max Incremental increase} &= 12 / (T - 2) \text{ where } T = \text{ambient temp} \\ &= 12 / (13.4 - 2) \\ &= 1.05^\circ \end{aligned}$ $\begin{aligned} \text{Max Incremental increase} &> (T_{\text{effluent}95} - T_{\text{ambient}90})/DF \\ 1.05^\circ &> (21.0 - 13.4) / 9.7 \\ 1.05^\circ &> 0.78^\circ \end{aligned}$ <p>This calculation is based on the requirements of WAC 173-201a-210(1)(c)(ii)(A)]. Under these assumptions, the effluent discharge from this facility results in warming of the ambient temperature by 0.78°C, which is less than the allowable warming temperature of 1.05°C. Therefore, the proposed permit does not include a temperature limit.</p>

Henderson/MLK CSO Treatment Plant	
Dissolved Oxygen - BOD ₅	Calculations show there is no reasonable potential for the Henderson/MLK CSO treatment plant to violate DO water quality standards. For calculations see Appendix F.
pH	Ecology modeled the impact of the effluent pH on the receiving water using the calculations from EPA, 1988, and the chronic dilution factor of 10.3 (see Appendix F). The receiving water input variables used were obtained from King County's 2013 receiving water study and the effluent characteristics were obtained from DMRs. Using the assumed values, Ecology predicts no violation of the pH criteria under critical conditions. Therefore, the proposed permit includes technology-based effluent limits for pH.
Fecal Coliform	Ecology modeled the numbers of fecal coliform by simple mixing analysis. With the dilution factor of 10.3, the guidance-based limit of 400/100mL, and an ambient fecal concentration of 110/100 mL obtained from King County's 2013 receiving water study, Ecology calculated a fecal coliform concentration at the edge of the mixing zone boundary of 138/100mL, which is below the water quality standard of 200 colonies/100 mL (for freshwater recreational secondary contact). Therefore, the proposed permit includes the guidance-based effluent limit for fecal coliform bacteria, on a monthly basis, since it is protective of water quality and more stringent than the water quality-based limit.
Toxics	<p>Based on three sampling events, the following toxic pollutants were detected in the Henderson/MLK CSO treatment plant's discharge: ammonia, antimony, arsenic, bis(2-ethylhexyl)phthalate, cadmium, chlorine, chloroform, chromium (hex), chromium (tri), copper, dichlorobromomethane, 2-4 dichlorophenol, diethylphthalate, dimethylphthalate, di-n-butyl phthalate, lead, mercury, nickel, phenol, zinc, and cyanide.</p> <p>Ecology did not conduct a reasonable potential analysis on these parameters because it would not be prudent to set a limit based on three data points. Instead, Ecology is requiring the County to sample for priority pollutants during the next permit cycle for re-assessment with the next permit issuance.</p> <p>Ecology derived an effluent limit for chlorine using methods from EPA, 1991 as shown in Appendix F. The proposed chlorine effluent limit is based on the dilution factors King County calculated using recent effluent flow data. The resultant maximum daily average effluent limit for chlorine is 25 µg/L, but since the chlorine analyzers cannot accurately measure in this range the limit was kept at 39 µg/L. This limit will be protective of the maximum daily water quality criteria since additional chlorine decay occurs in the 5000 foot outfall line. Also, the Henderson/MLK facility typically discharges for less than 24 hours, therefore, if the proposed limit is met, the daily average concentration will be less than 25 µg/L.</p>
Temperature	<p>The County was not required to collect temperature data for this facility so Ecology used West Point data for this assessment. Using the 95th percentile of West Point's 1DADmax (21.0°C) and a dilution factor of 10.3, no reasonable potential exists to exceed the temperature criterion where:</p> $0.3 > (T_{\text{effluent}95} - T_{\text{ambient}90})/DF$ $0.3 > (21.0 - 18.7)/10.3$ $0.3 > 0.2$ <p>Under these assumptions, the effluent discharge from this facility results in warming of the ambient temperature by 0.22°C, which is less than the allowable warming temperature of 0.3°C. Therefore, the proposed permit does not include a temperature limit.</p>

G. Human health

Washington's water quality standards include 91 numeric human health-based criteria that Ecology must consider when writing NPDES permits. These criteria were established in 1992 by the U.S. EPA in its National Toxics Rule (40 CFR 131.36). The National Toxics Rule allows states to use mixing zones to evaluate whether discharges comply with human health criteria.

Ecology determined the effluents for the West Point WWTP, Alki CSO TP, Carkeek CSO TP, Elliott West CSO TP, and the Henderson/MLK CSO TP may contain chemicals of concern for human health, based on (1) the facilities' status as EPA major dischargers, or (2) data or information indicating regulated chemicals occur in the discharges. Ecology evaluated the discharges' potential to violate the water quality standards as required by 40 CFR 122.44(d) by following the procedures published in the *Technical Support Document for Water Quality-Based Toxics Control* (EPA/505/2-90-001) and Ecology's *Permit Writer's Manual* to make reasonable potential determinations (Appendix F). For all facilities listed above, the evaluations showed that the discharges have no reasonable potential to cause violation of the human health water quality standards and effluent limits are not needed.

H. Sediment quality

The aquatic sediment standards (chapter 173-204 WAC) protect aquatic biota and human health. Under these standards Ecology may require a facility to evaluate the potential for its discharge to cause a violation of sediment standards (WAC 173-204-400). You can obtain additional information about sediments at the Aquatic Lands Cleanup Unit website. <http://www.ecy.wa.gov/programs/tcp/smu/sediment.html>

Ecology determined that the West Point WWTP discharge has potential to cause a violation of the sediment quality standards because:

- Past sediment testing near the outfall has shown some inconclusive evidence of toxicity to benthic organisms (refer to Section II.E for more information).
- Past sediment testing near CSO locations has shown exceedances of the Sediment Management Standard.

The proposed permit includes a condition requiring King County to:

- Continue sediment and effluent testing to investigate the source and extent of toxicity at the West Point WWTP outfall.
- Provide an update to the 2009 CSO sediment report that summarizes activities and existing data for sediment quality at the CSO locations.
- Submit a post-construction monitoring summary report for CSO outfalls that will be controlled during this permit term.
- Model or sample sediments at five controlled CSO outfall locations: E. Pine Street Pump Station Emergency Overflow (011), Belvoir (012)/30th Ave NE Pump Station (049), Martin Luther King (013)/Henderson Pump Station (045), Matthews Park Pump Station Emergency Overflow (018), and Rainier Avenue Pump Station Emergency Overflow (033).

I. Whole effluent toxicity

The water quality standards for surface waters forbid discharge of effluent that has the potential to cause toxic effects in the receiving waters. Many toxic pollutants cannot be measured by commonly available detection methods. However, laboratory tests can measure toxicity directly by exposing living organisms to the wastewater and measuring their responses. These tests measure the aggregate toxicity of the whole effluent, so this approach is called whole effluent toxicity (WET) testing. Some WET tests measure acute toxicity and other WET tests measure chronic toxicity.

- *Acute toxicity tests measure mortality as the significant response* to the toxicity of the effluent. Dischargers who monitor their wastewater with acute toxicity tests find early indications of any potential lethal effect of the effluent on organisms in the receiving water.
- *Chronic toxicity tests measure various sublethal toxic responses*, such as reduced growth or reproduction. Chronic toxicity tests often involve either a complete life cycle test on an organism with an extremely short life cycle, or a partial life cycle test during a critical stage of a test organism's life. Some chronic toxicity tests also measure organism survival.

Laboratories accredited by Ecology for WET testing know how to use the proper WET testing protocols, fulfill the data requirements, and submit results in the correct reporting format. Accredited laboratory staff know about WET testing and how to calculate an NOEC, LC50, EC50, IC25, etc. Ecology gives all accredited labs the most recent version of Ecology Publication No. WQ-R-95-80, *Laboratory Guidance and Whole Effluent Toxicity Test Review Criteria* (<http://www.ecy.wa.gov/biblio/9580.html>), which is referenced in the permit. Ecology recommends that King County send a copy of the acute or chronic toxicity sections of its NPDES permit to the laboratory.

WET testing conducted during effluent characterization at the West Point WWTP showed no reasonable potential to cause receiving water acute or chronic toxicity, therefore the proposed permit does not include WET limits. King County must retest the West Point WWTP effluent before submitting an application for permit renewal.

- If this facility makes process or material changes which, in Ecology's opinion, increase the potential for effluent toxicity, then Ecology may (in a regulatory order, by permit modification, or in the permit renewal) require the facility to conduct additional effluent characterization. King County may demonstrate to Ecology that effluent toxicity has not increased by performing additional WET testing and/or chemical analyses after the process or material changes have been made. Ecology recommends that the Permittee check first to make sure that Ecology will consider the demonstration adequate to support a decision to not require an additional effluent characterization.
- If WET testing conducted for submittal with a permit application fails to meet the performance standards in WAC 173-205-020, Ecology will assume that effluent toxicity has increased. King County may demonstrate to Ecology that effluent toxicity has not increased by performing additional WET testing after the process or material changes have been made.

J. Groundwater quality limits

The groundwater quality standards (chapter 173-200 WAC) protect beneficial uses of groundwater. Permits issued by Ecology must not allow violations of those standards (WAC 173-200-100). King County does not discharge wastewater to the ground. No permit limits are required to protect groundwater.

K. Comparison of effluent limits with the previous permit

The proposed limits are compared to those of the current permit in Table 50 through Table 54. For the CSO treatment plants, Ecology evaluates settleable solids compliance using the 0.3 ml/l/hr yearly average limit due to the intermittent and highly variable operation of the CSOs. Ecology removed the settleable solids event maximum limit of 1.9 ml/l/hr because there is no basis in regulation for an event maximum limit.

Table 50. Comparison of Previous and Proposed Effluent Limits - West Point WWTP

Parameter	Basis of Limit	Previous Effluent Limits		Proposed Effluent Limits	
		Average Monthly	Average Weekly	Average Monthly	Average Weekly
CBOD (5-day)	Technology	25 mg/L, 44,800 lb/day 80% removal (Nov-April) 85% removal (May-Oct)	40 mg/L, 71,700 lb/day	25 mg/L, 44,800 lb/day 80% removal (Nov-April) 85% removal (May-Oct)	40 mg/L, 71,700 lb/day
TSS	Technology	30 mg/L, 53,800 lb/day 80% removal (Nov-April) 85% removal (May-Oct)	45 mg/L, 80,700 lb/day	30 mg/L, 53,800 lb/day 80% removal (Nov-April) 85% removal (May-Oct)	45 mg/L, 80,700 lb/day
Fecal Coliform Bacteria	Technology	200/100 mL	400/100 mL	200/100 mL	400/100 mL
pH	Technology	Daily Minimum is equal to or greater than 6.0 and the daily maximum is less than or equal to 9.0			
		Average Monthly	Maximum Daily	Average Monthly	Maximum Daily
Total Residual Chlorine	Water Quality-Based	139 µg/L	364 µg/L	139 µg/L	364 µg/L

Table 51. Comparison of Previous and Proposed Effluent Limits - Alki CSO TP

Parameter	Previous Effluent Limits			Proposed Effluent Limits		
	Monthly Average	Annual Average	Long-Term Average	Monthly Average	Annual Average	Long-Term Average
TSS Removal Efficiency, %	NA	50%	NA	NA	50%	NA
Settleable Solids (mL/L/hr)	1.9 Maximum per event	0.3	NA	no limit	0.3	NA
Fecal Coliform Bacteria	400/100mL	NA	NA	400/100mL	NA	NA
Number of events per year	NA	NA	29/yr	NA	NA	29/yr
Average Vol. per yr, MG	NA	NA	108 MG/yr	NA	NA	108 MG/yr
pH	Daily Minimum is equal to or greater than 6.0 and the daily maximum is less than or equal to 9.0					
	Average Monthly		Maximum Daily	Average Monthly		Maximum Daily
Total Residual Chlorine	NA		234 µg/L	NA		234 µg/L

Table 52. Comparison of Previous and Proposed Effluent Limits - Carkeek CSO TP

Parameter	Previous Effluent Limits			Proposed Effluent Limits		
	Monthly Average	Annual Average	Long-Term Average	Monthly Average	Annual Average	Long-Term Average
TSS Removal Efficiency, %	NA	50%	NA	NA	50%	NA
Settleable Solids (mL/L/hr)	1.9 Maximum per event	0.3	NA	no limit	0.3	NA
Fecal Coliform Bacteria	400/100mL	NA	NA	400/100mL	NA	NA
Number of events per year	NA	NA	10/yr	NA	NA	10/yr
Average Vol. per yr, MG	NA	NA	46 MG/yr	NA	NA	46 MG/yr
pH	Daily Minimum is equal to or greater than 6.0 and the daily maximum is less than or equal to 9.0					
	Average Monthly		Maximum Daily	Average Monthly		Maximum Daily
Total Residual Chlorine	NA		490 µg/L	NA		490 µg/L

Table 53. Comparison of Previous and Proposed Effluent Limits - Elliott West CSO TP

Parameter	Previous Effluent Limits			Proposed Effluent Limits		
	Monthly Average	Annual Average	Long-Term Average	Monthly Average	Annual Average	Long-Term Average
TSS Removal Efficiency, %	Report	50%	NA	Report	50%	NA
Settleable Solids (mL/L/hr)	1.9 Maximum per event	0.3	NA	no limit	0.3	NA
Fecal Coliform Bacteria	Interim 400/100 mL Final 154/100 mL (calculated w/ '1' for non-discharge days)	NA	NA	400/100 mL (not calculated w/ '1' for non-discharge days)	NA	NA
Number of events per year	NA	Report	NA	NA	Report	NA
Average Vol. per yr, MG	NA	Report	NA	NA	Report	NA
pH	Daily Minimum is equal to or greater than 6.0 and the daily maximum is less than or equal to 9.0					
	Average Monthly		Maximum Daily	Average Monthly		Maximum Daily
Total Residual Chlorine	NA		104 µg/L	NA		109 µg/L

Table 54. Comparison of Previous and Proposed Effluent Limits – Henderson/MLK TP

Parameter	Previous Effluent Limits			Proposed Effluent Limits		
	Monthly Average	Annual Average	Long-Term Average	Monthly Average	Annual Average	Long-Term Average
TSS Removal Efficiency, %	NA	50%	NA	NA	50%	NA
Settleable Solids (mL/L/hr)	1.9 Maximum per event	0.3	NA	no limit	0.3	NA
Fecal Coliform Bacteria	400/100 mL	Report	NA	400/100 mL	Report	NA
Number of events per year	NA	Report	NA	NA	Report	NA
Average Vol. per yr, MG	NA	Report	NA	NA	Report	NA
pH	Daily Minimum is equal to or greater than 6.0 and the daily maximum is less than or equal to 9.0					
	Average Monthly		Maximum Daily	Average Monthly		Maximum Daily
Total Residual Chlorine	NA		39 µg/L	NA		39 µg/L

IV. Monitoring Requirements

Ecology requires monitoring, recording, and reporting (WAC 173-220-210 and 40 CFR 122.41) to verify that the treatment process is functioning correctly and that the discharge complies with the permit's effluent limits.

If a facility uses a contract laboratory to monitor wastewater, it must ensure that the laboratory uses the methods and meets or exceeds the method detection levels required by the permit. The permit describes when facilities may use alternative methods. It also describes what to do in certain situations when the laboratory encounters matrix effects. When a facility uses an alternative method as allowed by the permit, it must report the test method, DL, and QL on the discharge monitoring report or in the required report.

A. Wastewater monitoring

The monitoring schedule is detailed in the proposed permit under Special Condition S2. Specified monitoring frequencies take into account the quantity and variability of the discharges, the treatment methods, past compliance, significance of pollutants, and cost of monitoring. The required monitoring frequency for the West Point WWTP is consistent with or more conservative than agency guidance given in Ecology's *Permit Writer's Manual* (Publication Number 92-09) for municipal activated sludge facilities with design flows greater than 5 MGD.

Ecology has included some additional monitoring of nutrients in the proposed permit to establish a baseline for this discharger. Ecology will use this data if TMDLs for dissolved oxygen are developed and waste load allocations for nutrients are established.

Monitoring of sludge quantity and quality is necessary to determine the appropriate uses of the biosolids. Biosolids monitoring is required by the current state and local solid waste management program and also by EPA under 40 CFR 503.

As a pretreatment publicly owned treatment works (POTW), King County is required to sample influent, primary clarifier effluent, final effluent, and sludge for toxic pollutants in order to characterize the industrial input. Sampling is also done to determine if pollutants interfere with the treatment process or pass-through the plant to the sludge or the receiving water. King County will use the monitoring data to develop local limits which commercial and industrial users must meet.

The proposed permit requires King County to monitor for sediments, whole effluent toxicity, and priority pollutants to further characterize the discharges. These pollutants could have a significant impact on the quality of the surface water.

B. Lab accreditation

Ecology requires that facilities must use a laboratory registered or accredited under the provisions of chapter 173-50 WAC, Accreditation of Environmental Laboratories, to prepare all monitoring data (with the exception of certain parameters). Ecology accredited the laboratory at this facility for the parameters listed in Table 55.

Table 55. Lab Accredited Parameters

Parameter Name	Analyte ID	Method Name	Method Code
Solids, Total Volatile	1970	EPA 160.4_1971	10010409
Chemical Oxygen Demand (COD)	1565	HACH 8000	90004005
Alkalinity	1505	SM 2320 B-97	20045607
Hardness, Total (as CaCO ₃)	1755	SM 2340 C-97	20047603
Specific Conductance	1610	SM 2510 B-97	20048606
Solids, Total	1950	SM 2540 B-97	20049405
Solids, Total Dissolved	1955	SM 2540 C-97	20050402
Solids, Total Suspended	1960	SM 2540 D-97	20051201
Solids, Settleable	1965	SM 2540 F-97	20052204
Chlorine (Residual), Total	1940	SM 4500-CI D-00	20080108
Chlorine (Residual), Total	1940	SM 4500-CI E-00	20080415
Chloride	1575	SM 4500-Cl ⁻ C-97	20085205
pH	1900	SM 4500-H ⁺ B-00	20105219
Ammonia	1515	SM 4500-NH ₃ E-97	20110605
Nitrogen, Total Kjeldahl	1795	SM 4500-Norg B-97	20119204
Dissolved Oxygen	1880	SM 4500-O G-01	20121408
Orthophosphate	1870	SM 4500-P E-99	20124214
Phosphorus, Total	1910	SM 4500-P E-99	20124214
Sulfate	2000	SM 4500-SO ₄ ⁻ E-97	20132803
BOD, Carbonaceous BOD (CBOD)	1532	SM 5210 B-01	20135006
Fecal coliform-count	2530	SM 9221 E2 (A1) + C MPN	20196207
Total coliforms-count	2500	SM 9222 B (M-endo)-97	20203207

V. Other Permit Conditions

A. Reporting and record keeping

Ecology based Special Condition S3 on its authority to specify any appropriate reporting and record keeping requirements to prevent and control waste discharges (WAC 173-220-210).

B. Prevention of facility overloading

Overloading of the treatment plant is a violation of the terms and conditions of the permit. To prevent this from occurring, RCW 90.48.110 and WAC 173-220-150 require King County to:

- Take the actions detailed in proposed permit Special Condition S4.
- Design and construct expansions or modifications before the treatment plant reaches existing capacity.
- Report and correct conditions that could result in new or increased discharges of pollutants.

Special Condition S4 restricts the amount of flow.

If a municipality intends to apply for Ecology-administered funding for the design or construction of a facility project, the plan must meet the standard of a *Facility Plan*, as defined in WAC 173-98-030. A complete *Facility Plan* includes all elements of an *Engineering Report* along with State Environmental Review Process (SERP) documentation to demonstrate compliance with 40 CFR 35.3140 and 40 CFR 35.3145, and a cost effectiveness analysis as required by WAC 173-98-730. The municipality should contact Ecology's regional office as early as practical before planning a project that may include Ecology-administered funding.

C. Operation and maintenance

The proposed permit contains Special Condition S5 as authorized under RCW 90.48.110, WAC 173-220-150, chapter 173-230 WAC, and WAC 173-240-080. Ecology included it to ensure proper operation and regular maintenance of equipment, and to ensure that King County takes adequate safeguards so that it uses constructed facilities to their optimum potential in terms of pollutant capture and treatment.

D. Pretreatment

Duty to enforce discharge prohibitions

This provision prohibits the publicly owned treatment works (POTW) from authorizing or permitting an industrial discharger to discharge certain types of waste into the sanitary sewer.

- The first section of the pretreatment requirements prohibits the POTW from accepting pollutants which causes “pass-through” or “interference”. This general prohibition is from 40 CFR §403.5(a). *Appendix C* of this fact sheet defines these terms.
- The second section reinforces a number of specific state and federal pretreatment prohibitions found in WAC 173-216-060 and 40 CFR §403.5(b). These reinforce that the POTW may not accept certain wastes, which:
 - a. Are prohibited due to dangerous waste rules.
 - b. Are explosive or flammable.
 - c. Have too high or low of a pH (too corrosive, acidic or basic).
 - d. May cause a blockage such as grease, sand, rocks, or viscous materials.
 - e. Are hot enough to cause a problem.
 - f. Are of sufficient strength or volume to interfere with treatment.
 - g. Contain too much petroleum-based oils, mineral oil, or cutting fluid.
 - h. Create noxious or toxic gases at any point.

40 CFR Part 403 contains the regulatory basis for these prohibitions, with the exception of the pH provisions which are based on WAC 173-216-060.

- The third section of pretreatment conditions reflects state prohibitions on the POTW accepting certain types of discharges unless the discharge has received prior written authorization from Ecology. These discharges include:
 - a. Cooling water in significant volumes.
 - b. Stormwater and other direct inflow sources.

- c. Wastewaters significantly affecting system hydraulic loading, which do not require treatment.

Ecology delegated authority to King County for permitting, monitoring, and enforcement over industrial users discharging to their treatment system to provide more direct and effective control of pollutants. Ecology oversees the delegated Industrial Pretreatment Program to assure compliance with federal pretreatment regulations (40 CFR Part 403) and categorical standards and state regulations (chapter 90.48 RCW and chapter 173-216 WAC).

As sufficient data becomes available, King County must, in consultation with Ecology, reevaluate its local limits in order to prevent pass-through or interference. If any pollutant causes pass-through or interference, or exceeds established biosolids standards, King County must establish new local limits or revise existing local limits as required by 40 CFR 403.5. In addition, Ecology may require revision or establishment of local limits for any pollutant that causes a violation of water quality standards or established effluent limits, or that causes whole effluent toxicity.

E. Solid wastes

To prevent water quality problems the facility is required in permit Special Condition S7 to store and handle all residual solids (grit, screenings, scum, sludge, and other solid waste) in accordance with the requirements of RCW 90.48.080 and state water quality standards.

The final use and disposal of biosolids from this facility is regulated by U.S. EPA under 40 CFR 503, and by Ecology under chapter 70.95J RCW, chapter 173-308 WAC "Biosolids Management," and chapter 173-350 WAC "Solid Waste Handling Standards." The disposal of other solid waste is under the jurisdiction of Public Health - Seattle and King County.

Requirements for monitoring biosolids and record keeping are included in this permit. Ecology will use this information, required under 40 CFR 503, to develop or update local limits.

F. Spill plan

The permitted facilities store a quantity of chemicals on-site that have the potential to cause water pollution if accidentally released. Ecology can require a facility to develop best management plans to prevent this accidental release [Section 402(a)(1) of the Federal Water Pollution Control Act (FWPCA) and RCW 90.48.080].

King County developed a plan for preventing the accidental release of pollutants to state waters and for minimizing damages if such a spill occurs. The proposed permit requires the facility to review the plan annually and send revised plans to Ecology when significant changes are made.

G. Combined sewer overflows

Combined sewer systems are sewers that are designed to collect rainwater runoff, domestic sewage, and industrial wastewater in the same piping system. Most of the time, combined sewer systems transport all wastewater to a sewage treatment plant, where it is treated and then discharged to a water body. During periods of heavy rainfall or snowmelt, however, the wastewater volume in a combined sewer system can exceed the capacity of the combined sewer system or treatment plant. For this reason, combined sewer systems are designed to overflow occasionally and discharge excess wastewater directly to nearby streams, rivers, or

other water bodies. Chapter 173-245 WAC and EPA's CSO control policy (59 FR 18688) identify the required measures for control of overflows from combined sewer systems.

CSO Reduction Plan/Long-Term Control Plan and CSO Reduction Plan Amendments

Ecology requires municipalities to initially develop combined sewer overflow (CSO) reduction plans per chapter 173-245 WAC requirements. These plans are substantially equivalent to the long-term control plan (LTCP) as defined by EPA in its CSO control policy. Chapter 173-245 WAC requires that "all CSO sites shall achieve and at least maintain the greatest reasonable reduction, and neither cause violations of applicable water quality standards, nor restrictions to the characteristic uses of the receiving water, nor accumulation of deposits which: (a) exceed sediment criteria or standards; or (b) have an adverse biological effect." The *greatest reasonable reduction* means control of each CSO outfall such that an average of no more than one untreated discharge may occur per year.

Under EPA's CSO Control Policy's presumption approach, CSO controls are presumed to attain WQS if certain performance criteria are met. Ecology presumes that a program that meets the criteria specified in WAC 173-245 and EPA's CSO control policy provides an adequate level of control to meet the water quality-based requirements of the Clean Water Act. This presumption must be verified via a post-construction monitoring program by characterization, monitoring, and modeling of the system, including consideration of sensitive areas.

King County submitted a CSO reduction plan amendment in 2012 (King County's *2012 Long Term CSO Control Plan Amendment*). The proposed permit requires King County to submit an amendment of its CSO reduction plan in conjunction with its application for permit renewal. The amendment must include an assessment of the effectiveness of the CSO reduction plan, a re-evaluation of CSO project priorities, and a list of projects to be completed in the next five years. In addition, King County must identify newly corrected or controlled CSOs that meet the state's one untreated discharge per year per CSO standard in the CSO Reduction Plan Amendment.

Nine Minimum Controls

Municipalities with combined sewer overflow outfalls must implement nine minimum controls as technology-based standards for CSO discharges. The nine minimum controls are largely programmatic policies and practices designed to minimize the impacts untreated CSOs have on human health and the environment. It is not possible with current knowledge and technology to calculate numeric water quality-based effluent limits for CSOs.

The nine minimum controls include:

1. Use proper operations and maintenance practices within the combined collection system to reduce the magnitude, frequency and duration of CSOs.
2. Implement procedures that maximize storage capacity of the combined collection system.
3. Minimize pollution from non-domestic wastewater sources through close management of a pretreatment program.
4. Maximize treatable flow to the wastewater treatment plant during wet weather.
5. Prevent CSO discharges during dry weather and properly report any dry weather CSO discharges immediately to Ecology.
6. Implement procedures to control solid and floatable materials in CSOs.
7. Implement and maintain a pollution prevention program designed to keep pollutants from entering the combined sewer system.

8. Establish a process to notify the public when and where CSOs occur.
9. Monitor CSO outfalls to characterize CSO impacts and the efficacy of CSO controls, including event-based monitoring of all CSO flow quantity, frequency and duration.

CSO Monitoring

The proposed permit requires King County to monitor the volume, duration, and precipitation associated with each CSO discharge event at each identified outfall.

Annual CSO Report

King County must submit annual reports according to the requirements of WAC 173-245-090(1). This report: (a) details the past year's frequency and volume of combined sewage discharge from each CSO site, (b) explains the previous year's CSO reduction accomplishments, and (c) lists the projects planned for the next year. The report must indicate whether a CSO site has increased over the baseline annual condition. The report must document implementation of the nine minimum controls, and wet weather operation (flow blending) at the West Point WWTP.

King County must also assess in its annual reports and CSO reduction plan amendment whether identified outfalls meet the state standard of one untreated discharge per year per CSO. Assessment may be based on a long-term average, which is defined as a 20-year averaging period.

King County may choose to indicate in the annual report which CSO events were exacerbated. For this purposes, exacerbated CSO shall mean any overflow at a CSO outfall that, while already discharging as a result of precipitation, is worsened by mechanical failures, blockages, power outages, and/or human error.

Post-Construction Monitoring Program

The federal CSO control policy (59 FR 18688) requires post-construction monitoring to verify implemented CSO control strategies comply with water quality standards. Post-construction monitoring applies to any CSO outfall that is controlled to meet the "greatest reasonable reduction" of combined sewer overflows, as defined in chapter 173-245 WAC. Implementation requires development of a monitoring plan and completion of a data report that documents compliance. The proposed permit requires King County to implement their *2012 Post Construction Monitoring Plan* and to submit any plan modifications to Ecology for review and approval.

H. Outfall evaluation

The proposed permit requires King County to conduct outfall inspections of the West Point WWTP and CSO treatment plant outfalls and submit a report detailing the findings of those inspections (Special Condition S14). The inspections must evaluate the physical condition of the discharge pipes and diffusers, and evaluate the extent of sediment accumulations in the vicinity of the outfalls.

I. Elliott West CSO treatment plant – copper reduction assessment

King County must assess copper discharges from the Elliott West CSO treatment plant and submit a *Copper Reduction Assessment Report* to Ecology. The County has consistently measured copper concentrations from the facility at five times higher than other CSO facilities. The proposed permit requires the County to determine if these measurements

accurately reflect copper concentrations in the effluent or if there is sample interference. The study also requires the County to evaluate various copper reduction strategies.

J. Elliott West CSO treatment plant – settleable solids removal assessment

The Elliott West CSO treatment facility has difficulty meeting its annual settleable solids limit. The proposed permit requires the County to assess ways to reduce settleable solids from its discharge.

K. General conditions

Ecology bases the standardized General Conditions on state and federal law and regulations. They are included in all individual domestic wastewater NPDES permits issued by Ecology.

VI. Permit Issuance Procedures

A. Permit modifications

Ecology may modify this permit to impose numerical limits, if necessary to comply with water quality standards for surface waters, with sediment quality standards, or with water quality standards for groundwaters, based on new information from sources such as inspections, effluent monitoring, outfall studies, and effluent mixing studies.

Ecology may also modify this permit to comply with new or amended state or federal regulations.

B. Proposed permit issuance

This proposed permit meets all statutory requirements for Ecology to authorize a wastewater discharge. The permit includes limits and conditions to protect human health and aquatic life, and the beneficial uses of waters of the state of Washington. Ecology proposes to issue this permit for a term of 5 years.

VII. References for Text and Appendices

Ecology. Laws and Regulations (<http://www.ecy.wa.gov/laws-rules/index.html>)

Ecology. Permit and Wastewater Related Information
(<http://www.ecy.wa.gov/programs/wq/permits/guidance.html>)

Ecology 1995. *Sediment Management Standards*. Chapter 173-204 WAC. Amended December 1995.
http://www.ecy.wa.gov/programs/tcp/smu/sed_standards.htm

Ecology 1998. Chapter E-1, *Criteria For Sewage Works Design*, Ecology Publication # 98-37.

Ecology 2002. *Final Sediment Management Standards Cleanup Action Decision Duwamish/Diagonal CSO/SD*. Department of Ecology NWRO TCP. July 25, 2002.

Environmental Protection Agency (EPA). 1983. *Water Quality Standards Handbook*. USEPA Office of Water, Washington, D.C.

EPA, 1985. *Water Quality Assessment: A Screening Procedure for Toxic and Conventional Pollutants in Surface and Ground Water*. EPA/600/6-85/002a.

EPA, 1991. *Technical Support Document for Water Quality-based Toxics Control*. EPA/505/2-90-001.

- EPA, 1992. *National Toxics Rule. Federal Register*, V. 57, No. 246, Tuesday, December 22, 1992.
- EPA, 1995. *Combined Sewer Overflow Guidance for Permit Writers*, EPA, August 1995.
- King County. 1996. *Norfolk CSO cleanup study report*. Prepared for Elliott Bay/Duwamish Restoration Program Panel. Panel Publication 13. King County Department of Natural Resources, Seattle, WA. (<http://www.kingcounty.gov/environment/wastewater/SedimentManagement/Projects/Norfolk/Library.aspx>)
- King County, 1999. *King County Department of Natural Resources Year 2000 CSO Plan Update Project, Sediment Management Plan*. Prepared by Anchor Environmental and Herrera Environmental Consultants in collaboration with King County. June 1999.
- King County, 1999. *Sediment remediation plan, Denny Way/Lake Union CSO Control Project*. Prepared for King County and Black and Veatch. Seattle, Washington.
- King County. 2005. *The Denny Way sediment cap – 2000 data – final monitoring report*. King County Department of Natural Resources. Seattle, Washington.
- King County. June 2005. *Norfolk CSO Sediment Remediation Project Five-Year Monitoring Program, Final Monitoring Report, Year Five*. Prepared for the Elliott Bay/Duwamish Restoration Program Panel, Panel Publication 38. King County Department of Natural Resources. Seattle, Washington.
- King County 2006. *West Point Wastewater Treatment Plant 2006 Outfall Sediment Sampling Event Final Report*. King County Department of Natural Resources and Parks, Marine and Sediment Assessment Group, September 2007. *SEDQUAL* data WPNT06.
- King County 2008. *Denny Way CSO and Elliott West CSO Treatment Facility, Post-Construction Sediment Monitoring Sampling and Analysis Plan*. Prepared by King County Department of Natural Resources and Parks Marine and Sediment Assessment Group. March 2008.
- King County, *CSO Sediment Quality Characterization Final Sampling and Analysis Plan*, Aug 2011.
- King County, *Technical Memorandum - Feasible Alternatives Analysis for CSO-Related Secondary Process Diversion at West Point Treatment Plant*, May 21, 2009.
- King County, *2009 Comprehensive Sediment Quality Summary Report for CSO Discharge Locations*, Dec 2009.
- King County, *CSO Sediment Quality Characterization Final Sampling and Analysis Plan*, Aug 2011.
- King County, *Post Construction Monitoring Plan for King County CSO Controls*, Sept 2012.
- King County, *2012 Long Term CSO Control Plan Amendment*, October 2012.
- King County, *CSO Sediment Quality Characterization, 2011 Sediment Sampling Event*, Dec 2012.
- King County, *2013 Receiving Water Characterization Study, King County NPDES Monitoring Program, Final Report for Brightwater, South, Vashon, and West Point Treatment Plants and Alki, Carkeek, Elliott West, and Henderson/MLK CSO Storage and Treatment Facilities*, June 2013.
- King County, *Effluent Dilution Modeling Report for the West Point WWTP Outfall*, 2013.
- King County, *Effluent Dilution Modeling Report for the Alki CSO Treatment Plant Outfall*, 2013.
- King County, *Effluent Dilution Modeling Report for the Carkeek CSO Treatment Plant Outfall*, 2013.
- King County, *Effluent Dilution Modeling Report for the Elliott West CSO Treatment Plant Outfall*, 2013.
- King County, *Effluent Dilution Modeling Report for the Henderson/MLK CSO Treatment Plant Outfall*, 2013.

Washington State Department of Ecology. *Permit Writer's Manual*. Publication Number 92-109, December 2011. (<http://www.ecy.wa.gov/biblio/92109.html>)

Washington State Department of Health, 1994. *Design Criteria for Municipal Wastewater Land Treatment*.

Water Pollution Control Federation, *Chlorination of Wastewater*, 1976.

Windward Environmental LLC. 2008. *Lower Duwamish Waterway remedial investigation, remedial investigation report, draft final (internal)*. Prepared for submittal to EPA and Ecology. ([http://yosemite.epa.gov/r10/CLEANUP.NSF/LDW/Lower+Duwamish+Waterway+Draft+Phase+II+Remedial+Investigation+Report/\\$FILE/draft_riII.pdf](http://yosemite.epa.gov/r10/CLEANUP.NSF/LDW/Lower+Duwamish+Waterway+Draft+Phase+II+Remedial+Investigation+Report/$FILE/draft_riII.pdf))

Appendix A — Public Involvement Information

Ecology proposes to reissue a permit to King County. The permit includes wastewater discharge limits and other conditions. This fact sheet describes the facility and Ecology's reasons for requiring permit conditions.

Ecology placed a Public Notice of Draft on October 30, 2014, in the *Seattle Times* to inform the public and to invite comment on the proposed draft National Pollutant Discharge Elimination System permit and fact sheet.

The notice:

- Told where copies of the draft permit and fact sheet were available for public evaluation (a local public library, the closest regional or field office, posted on our website).
- Offered to provide the documents in an alternate format to accommodate special needs.
- Asked people to tell us how well the proposed permit would protect the receiving water.
- Invited people to suggest fairer conditions, limits, and requirements for the permit.
- Invited comments on Ecology's determination of compliance with antidegradation rules.
- Urged people to submit their comments, in writing, before the end of the comment period.
- Told how to request a public hearing about the proposed NPDES permit.
- Explained the next step(s) in the permitting process.

Ecology has published a document entitled *Frequently Asked Questions about Effective Public Commenting*, which is available on our website at <http://www.ecy.wa.gov/biblio/0307023.html>.

You may obtain further information from Ecology by telephone, 425-649-7201, or by writing to the address listed below.

Water Quality Permit Coordinator
Department of Ecology
Northwest Regional Office
3190 160th Avenue SE
Bellevue, WA 98008-5452

The primary author of this permit and fact sheet is Alison Evans, PE.

Appendix B — Your Right to Appeal

You have a right to appeal this permit to the Pollution Control Hearing Board (PCHB) within 30 days of the date of receipt of the final permit. The appeal process is governed by chapter 43.21B RCW and chapter 371-08 WAC. “Date of receipt” is defined in RCW 43.21B.001(2) (see glossary).

To appeal you must do the following within 30 days of the date of receipt of this permit:

- File your appeal and a copy of this permit with the PCHB (see addresses below). Filing means actual receipt by the PCHB during regular business hours.
- Serve a copy of your appeal and this permit on Ecology in paper form - by mail or in person. (See addresses below.) E-mail is not accepted.

You must also comply with other applicable requirements in chapter 43.21B RCW and chapter 371-08 WAC.

Street Addresses	Mailing Addresses
Department of Ecology Attn: Appeals Processing Desk 300 Desmond Drive SE Lacey, WA 98503	Department of Ecology Attn: Appeals Processing Desk PO Box 47608 Olympia, WA 98504-7608
Pollution Control Hearings Board 1111 Israel RD SW STE 301 Tumwater, WA 98501	Pollution Control Hearings Board PO Box 40903 Olympia, WA 98504-0903

Appendix C — Glossary

1-DMax or 1-day maximum temperature -- The highest water temperature reached on any given day. This measure can be obtained using calibrated maximum/minimum thermometers or continuous monitoring probes having sampling intervals of thirty minutes or less.

7-DADMax or 7-day average of the daily maximum temperatures -- The arithmetic average of seven consecutive measures of daily maximum temperatures. The 7-DADMax for any individual day is calculated by averaging that day's daily maximum temperature with the daily maximum temperatures of the three days prior and the three days after that date.

Acute toxicity --The lethal effect of a compound on an organism that occurs in a short time period, usually 48 to 96 hours.

AKART -- The acronym for “all known, available, and reasonable methods of prevention, control and treatment.” AKART is a technology-based approach to limiting pollutants from wastewater discharges, which requires an engineering judgment and an economic judgment. AKART must be applied to all wastes and contaminants prior to entry into waters of the state in accordance with RCW 90.48.010 and 520, WAC 173-200-030(2)(c)(ii), and WAC 173-216-110(1)(a).

Alternate point of compliance -- An alternative location in the groundwater from the point of compliance where compliance with the groundwater standards is measured. It may be established in the groundwater at locations some distance from the discharge source, up to, but not exceeding the property boundary and is determined on a site specific basis following an AKART analysis. An “early warning value” must be used when an alternate point is established. An alternate point of compliance must be determined and approved in accordance with WAC 173-200-060(2).

Ambient water quality -- The existing environmental condition of the water in a receiving water body.

Ammonia -- Ammonia is produced by the breakdown of nitrogenous materials in wastewater. Ammonia is toxic to aquatic organisms, exerts an oxygen demand, and contributes to eutrophication. It also increases the amount of chlorine needed to disinfect wastewater.

Annual average design flow (AADF) -- The average of the daily flow volumes anticipated to occur over a calendar year.

Average monthly (intermittent) discharge limit -- The average of the measured values obtained over a calendar months time taking into account zero discharge days.

Average monthly discharge limit -- The average of the measured values obtained over a calendar month's time.

Background water quality -- The concentrations of chemical, physical, biological or radiological constituents or other characteristics in or of groundwater at a particular point in time upgradient of an activity that has not been affected by that activity [WAC 173-200-020(3)]. Background water quality for any parameter is statistically defined as the 95% upper tolerance interval with a 95% confidence based on at least eight hydraulically upgradient water quality samples. The eight samples are collected over a period of at least one year, with no more than one sample collected during any month in a single calendar year.

Best management practices (BMPs) -- Schedules of activities, prohibitions of practices, maintenance procedures, and other physical, structural and/or managerial practices to prevent or reduce the pollution of waters of the state. BMPs include treatment systems, operating

procedures, and practices to control: plant site runoff, spillage or leaks, sludge or waste disposal, or drainage from raw material storage. BMPs may be further categorized as operational, source control, erosion and sediment control, and treatment BMPs.

BOD₅ -- Determining the five-day Biochemical Oxygen Demand of an effluent is an indirect way of measuring the quantity of organic material present in an effluent that is utilized by bacteria. The BOD₅ is used in modeling to measure the reduction of dissolved oxygen in receiving waters after effluent is discharged. Stress caused by reduced dissolved oxygen levels makes organisms less competitive and less able to sustain their species in the aquatic environment. Although BOD₅ is not a specific compound, it is defined as a conventional pollutant under the federal Clean Water Act.

Bypass -- The intentional diversion of waste streams from any portion of a treatment facility.

Categorical pretreatment standards -- National pretreatment standards specifying quantities or concentrations of pollutants or pollutant properties, which may be discharged to a POTW by existing or new industrial users in specific industrial subcategories.

Chlorine -- A chemical used to disinfect wastewaters of pathogens harmful to human health. It is also extremely toxic to aquatic life.

Chronic toxicity -- The effect of a compound on an organism over a relatively long time, often 1/10 of an organism's lifespan or more. Chronic toxicity can measure survival, reproduction or growth rates, or other parameters to measure the toxic effects of a compound or combination of compounds.

Clean water act (CWA) -- The federal Water Pollution Control Act enacted by Public Law 92-500, as amended by Public Laws 95-217, 95-576, 96-483, 97-117; USC 1251 et seq.

Compliance inspection-without sampling -- A site visit for the purpose of determining the compliance of a facility with the terms and conditions of its permit or with applicable statutes and regulations.

Compliance inspection-with sampling -- A site visit for the purpose of determining the compliance of a facility with the terms and conditions of its permit or with applicable statutes and regulations. In addition it includes as a minimum, sampling and analysis for all parameters with limits in the permit to ascertain compliance with those limits; and, for municipal facilities, sampling of influent to ascertain compliance with the 85 percent removal requirement. Ecology may conduct additional sampling.

Composite sample -- A mixture of grab samples collected at the same sampling point at different times, formed either by continuous sampling or by mixing discrete samples. May be "time-composite" (collected at constant time intervals) or "flow-proportional" (collected either as a constant sample volume at time intervals proportional to stream flow, or collected by increasing the volume of each aliquot as the flow increased while maintaining a constant time interval between the aliquots).

Construction activity -- Clearing, grading, excavation, and any other activity, which disturbs the surface of the land. Such activities may include road building; construction of residential houses, office buildings, or industrial buildings; and demolition activity.

Continuous monitoring -- Uninterrupted, unless otherwise noted in the permit.

Critical condition -- The time during which the combination of receiving water and waste discharge conditions have the highest potential for causing toxicity in the receiving water

environment. This situation usually occurs when the flow within a water body is low, thus, its ability to dilute effluent is reduced.

Date of receipt – This is defined in RCW 43.21B.001(2) as five business days after the date of mailing; or the date of actual receipt, when the actual receipt date can be proven by a preponderance of the evidence. The recipient's sworn affidavit or declaration indicating the date of receipt, which is unchallenged by the agency, constitutes sufficient evidence of actual receipt. The date of actual receipt, however, may not exceed forty-five days from the date of mailing.

Detection limit -- The minimum concentration of a substance that can be measured and reported with 99 percent confidence that the pollutant concentration is above zero and is determined from analysis of a sample in a given matrix containing the pollutant.

Dilution factor (DF) -- A measure of the amount of mixing of effluent and receiving water that occurs at the boundary of the mixing zone. Expressed as the inverse of the percent effluent fraction, for example, a dilution factor of 10 means the effluent comprises 10% by volume and the receiving water 90%.

Distribution uniformity -- The uniformity of infiltration (or application in the case of sprinkle or trickle irrigation) throughout the field expressed as a percent relating to the average depth infiltrated in the lowest one-quarter of the area to the average depth of water infiltrated.

Enforcement limit -- The concentration assigned to a contaminant in the groundwater at the point of compliance for the purpose of regulation, [WAC 173-200-020(11)]. This limit assures that a groundwater criterion will not be exceeded and that background water quality will be protected.

Engineering report -- A document that thoroughly examines the engineering and administrative aspects of a particular domestic or industrial wastewater facility. The report must contain the appropriate information required in WAC 173-240-060 or 173-240-130.

Exacerbated CSO -- Any overflow at a CSO outfall that, while already discharging as a result of precipitation, is worsened by mechanical failures, blockages, power outages, and/or human error.

Fecal coliform bacteria -- Fecal coliform bacteria are used as indicators of pathogenic bacteria in the effluent that are harmful to humans. Pathogenic bacteria in wastewater discharges are controlled by disinfecting the wastewater. The presence of high numbers of fecal coliform bacteria in a water body can indicate the recent release of untreated wastewater and/or the presence of animal feces.

Grab sample -- A single sample or measurement taken at a specific time or over as short a period of time as is feasible.

Groundwater -- Water in a saturated zone or stratum beneath the surface of land or below a surface water body.

Industrial user -- A discharger of wastewater to the sanitary sewer that is not sanitary wastewater or is not equivalent to sanitary wastewater in character.

Industrial wastewater -- Water or liquid-carried waste from industrial or commercial processes, as distinct from domestic wastewater. These wastes may result from any process or activity of industry, manufacture, trade or business; from the development of any natural resource; or from animal operations such as feed lots, poultry houses, or dairies. The term includes contaminated storm water and, also, leachate from solid waste facilities.

Interference -- A discharge which, alone or in conjunction with a discharge or discharges from other sources, both:

- Inhibits or disrupts the POTW, its treatment processes or operations, or its sludge processes, use or disposal; and
- Therefore is a cause of a violation of any requirement of the POTW's NPDES permit (including an increase in the magnitude or duration of a violation) or of the prevention of sewage sludge use or disposal in compliance with the following statutory provisions and regulations or permits issued thereunder (or more stringent State or local regulations): Section 405 of the Clean Water Act, the Solid Waste Disposal Act (SWDA) (including title II, more commonly referred to as the Resource Conservation and Recovery Act (RCRA), and including State regulations contained in any State sludge management plan prepared pursuant to subtitle D of the SWDA), sludge regulations appearing in 40 CFR Part 507, the Clean Air Act, the Toxic Substances Control Act, and the Marine Protection, Research and Sanctuaries Act.

Local limits -- Specific prohibitions or limits on pollutants or pollutant parameters developed by a POTW.

Major facility -- A facility discharging to surface water with an EPA rating score of > 80 points based on such factors as flow volume, toxic pollutant potential, and public health impact.

Maximum daily discharge limit -- The highest allowable daily discharge of a pollutant measured during a calendar day or any 24-hour period that reasonably represents the calendar day for purposes of sampling. The daily discharge is calculated as the average measurement of the pollutant over the day.

Maximum day design flow (MDDF) -- The largest volume of flow anticipated to occur during a one-day period, expressed as a daily average.

Maximum month design flow (MMDF) -- The largest volume of flow anticipated to occur during a continuous 30-day period, expressed as a daily average.

Maximum week design flow (MWDF) -- The largest volume of flow anticipated to occur during a continuous 7-day period, expressed as a daily average.

Minor facility -- A facility discharging to surface water with an EPA rating score of < 80 points based on such factors as flow volume, toxic pollutant potential, and public health impact.

Mixing zone -- An area that surrounds an effluent discharge within which water quality criteria may be exceeded. The permit specifies the area of the authorized mixing zone that Ecology defines following procedures outlined in state regulations (chapter 173-201A WAC).

National pollutant discharge elimination system (NPDES) -- The NPDES (Section 402 of the Clean Water Act) is the federal wastewater permitting system for discharges to navigable waters of the United States. Many states, including the state of Washington, have been delegated the authority to issue these permits. NPDES permits issued by Washington State permit writers are joint NPDES/State permits issued under both state and federal laws.

pH -- The pH of a liquid measures its acidity or alkalinity. It is the negative logarithm of the hydrogen ion concentration. A pH of 7 is defined as neutral and large variations above or below this value are considered harmful to most aquatic life.

Pass-through -- A discharge which exits the POTW into waters of the State in quantities or concentrations which, alone or in conjunction with a discharge or discharges from other sources, is a cause of a violation of any requirement of the POTW's NPDES permit

(including an increase in the magnitude or duration of a violation), or which is a cause of a violation of State water quality standards.

Peak hour design flow (PHDF) -- The largest volume of flow anticipated to occur during a one-hour period, expressed as a daily or hourly average.

Peak instantaneous design flow (PIDF) -- The maximum anticipated instantaneous flow.

Point of compliance -- The location in the groundwater where the enforcement limit must not be exceeded and a facility must comply with the Ground Water Quality Standards. Ecology determines this limit on a site-specific basis. Ecology locates the point of compliance in the groundwater as near and directly downgradient from the pollutant source as technically, hydrogeologically, and geographically feasible, unless it approves an alternative point of compliance.

Potential significant industrial user (PSIU) -- A potential significant industrial user is defined as an Industrial User that does not meet the criteria for a Significant Industrial User, but which discharges wastewater meeting one or more of the following criteria:

- a. Exceeds 0.5 % of treatment plant design capacity criteria and discharges <25,000 gallons per day; or
- b. Is a member of a group of similar industrial users which, taken together, have the potential to cause pass through or interference at the POTW (e.g. facilities which develop photographic film or paper, and car washes).

Ecology may determine that a discharger initially classified as a potential significant industrial user should be managed as a significant industrial user.

Quantitation level (QL) -- Also known as Minimum Level of Quantitation (ML) -- The lowest level at which the entire analytical system must give a recognizable signal and acceptable calibration point for the analyte. It is equivalent to the concentration of the lowest calibration standard, assuming that the lab has used all method-specified sample weights, volumes, and cleanup procedures. The QL is calculated by multiplying the MDL by 3.18 and rounding the result to the number nearest to $(1, 2, \text{ or } 5) \times 10^n$, where n is an integer (64 FR 30417).

ALSO GIVEN AS:

The smallest detectable concentration of analyte greater than the Detection Limit (DL) where the accuracy (precision & bias) achieves the objectives of the intended purpose. (Report of the Federal Advisory Committee on Detection and Quantitation Approaches and Uses in Clean Water Act Programs Submitted to the US Environmental Protection Agency, December 2007).

Reasonable potential -- A reasonable potential to cause a water quality violation, or loss of sensitive and/or important habitat.

Responsible corporate officer -- A president, secretary, treasurer, or vice-president of the corporation in charge of a principal business function, or any other person who performs similar policy- or decision-making functions for the corporation, or the manager of one or more manufacturing, production, or operating facilities employing more than 250 persons or have gross annual sales or expenditures exceeding \$25 million (in second quarter 1980 dollars), if authority to sign documents has been assigned or delegated to the manager in accordance with corporate procedures (40 CFR 122.22).

Significant industrial user (SIU) --

- 1) All industrial users subject to Categorical Pretreatment Standards under 40 CFR 403.6 and 40 CFR Chapter I, Subchapter N; and

- 2) Any other industrial user that: discharges an average of 25,000 gallons per day or more of process wastewater to the POTW (excluding sanitary, noncontact cooling, and boiler blow-down wastewater); contributes a process wastestream that makes up 5 percent or more of the average dry weather hydraulic or organic capacity of the POTW treatment plant; or is designated as such by the Control Authority* on the basis that the industrial user has a reasonable potential for adversely affecting the POTW's operation or for violating any pretreatment standard or requirement [in accordance with 40 CFR 403.8(f)(6)].

Upon finding that the industrial user meeting the criteria in paragraph 2, above, has no reasonable potential for adversely affecting the POTW's operation or for violating any pretreatment standard or requirement, the Control Authority* may at any time, on its own initiative or in response to a petition received from an industrial user or POTW, and in accordance with 40 CFR 403.8(f)(6), determine that such industrial user is not a significant industrial user.

*The term "Control Authority" refers to the Washington State Department of Ecology in the case of non-delegated POTWs or to the POTW in the case of delegated POTWs.

Slug discharge -- Any discharge of a non-routine, episodic nature, including but not limited to an accidental spill or a non-customary batch discharge to the POTW. This may include any pollutant released at a flow rate that may cause interference or pass through with the POTW or in any way violate the permit conditions or the POTW's regulations and local limits.

Solid waste -- All putrescible and non-putrescible solid and semisolid wastes including, but not limited to, garbage, rubbish, ashes, industrial wastes, swill, sewage sludge, biosolids, demolition and construction wastes, abandoned vehicles or parts thereof, contaminated soils and contaminated dredged material, and recyclable materials.

Soluble BOD₅ -- Determining the soluble fraction of Biochemical Oxygen Demand of an effluent is an indirect way of measuring the quantity of soluble organic material present in an effluent that is utilized by bacteria. Although the soluble BOD₅ test is not specifically described in Standard Methods, filtering the raw sample through at least a 1.2 um filter prior to running the standard BOD₅ test is sufficient to remove the particulate organic fraction.

State waters -- Lakes, rivers, ponds, streams, inland waters, underground waters, salt waters, and all other surface waters and watercourses within the jurisdiction of the state of Washington.

Stormwater--That portion of precipitation that does not naturally percolate into the ground or evaporate, but flows via overland flow, interflow, pipes, and other features of a storm water drainage system into a defined surface water body, or a constructed infiltration facility.

Technology-based effluent limit -- A permit limit based on the ability of a treatment method to reduce the pollutant.

Total coliform bacteria--A microbiological test, which detects and enumerates the total coliform group of bacteria in water samples.

Total dissolved solids--That portion of total solids in water or wastewater that passes through a specific filter.

Total maximum daily load (TMDL) -- A determination of the amount of pollutant that a water body can receive and still meet water quality standards.

Total suspended solids (TSS) -- Total suspended solids is the particulate material in an effluent. Large quantities of TSS discharged to a receiving water may result in solids accumulation.

Apart from any toxic effects attributable to substances leached out by water, suspended solids may kill fish, shellfish, and other aquatic organisms by causing abrasive injuries and by clogging the gills and respiratory passages of various aquatic fauna. Indirectly, suspended solids can screen out light and can promote and maintain the development of noxious conditions through oxygen depletion.

Upset -- An exceptional incident in which there is unintentional and temporary noncompliance with technology-based permit effluent limits because of factors beyond the reasonable control of the Permittee. An upset does not include noncompliance to the extent caused by operational error, improperly designed treatment facilities, lack of preventative maintenance, or careless or improper operation.

Water quality-based effluent limit -- A limit imposed on the concentration of an effluent parameter to prevent the concentration of that parameter from exceeding its water quality criterion after discharge into receiving waters.

Appendix D — Receiving Water Data

Receiving Water Metals Data

Parameter	KSBP01 (Carkeek, West Pt)						LSNT01 (Alki)					
	Min	Ave	Max	StdDev	Count	CV	Min	Ave	Max	StdDev	Count	CV
Antimony (µg/L)							0.1430	0.1631	0.1830	0.0102	32	
Arsenic (µg/L)	1.1100	1.3075	1.4300	0.0968	24	0.07	1.2200	1.3788	1.4900	0.0765	32	0.06
Cadmium (µg/L)	0.05200	0.06978	0.08640	0.00731	24	0.10	0.06110	0.07178	0.08300	0.00510	32	0.07
Chromium (µg/L)	0.08800	0.11700	0.19000	0.02531	24	0.22	0.08800	0.11638	0.18000	0.02417	32	0.21
Copper (µg/L)	0.2340	0.3795	1.2200	0.1955	24	0.52	0.2310	0.3749	1.9900	0.2996	32	0.80
Cyanide (µg/L)							0.005	0.005	0.005	0.000	16	0.00
Lead (µg/L)	0.0050	0.0127	0.0460	0.0127	24	0.99	0.0050	0.0159	0.0492	0.0139	32	0.88
Mercury (µg/L)	0.000200	0.000251	0.000550	0.000099	24	0.39	0.000200	0.000238	0.000400	0.000060	32	0.25
Nickel (µg/L)	0.387	0.422	0.593	0.039	24	0.09	0.390	0.424	0.511	0.027	32	0.06
Silver (µg/L)	0.01000	0.01642	0.03000	0.00754	24	0.46	0.01000	0.01625	0.03000	0.00733	32	0.45
Zinc (µg/L)	0.170	0.476	0.890	0.171	24	0.36	0.270	0.465	0.707	0.106	32	0.23

Parameter	LTED04 (Elliott West)						LTXQ01 (Henderson)					
	Min	Ave	Max	StdDev	Count	CV	Min	Ave	Max	StdDev	Count	CV
Antimony (µg/L)												
Arsenic (µg/L)	1.1200	1.3079	1.4500	0.0888	24	0.07	0.3910	0.5423	0.8570	0.1287	32	0.24
Cadmium (µg/L)	0.05520	0.06990	0.07990	0.00608	24	0.09	0.00500	0.01008	0.02300	0.00614	32	0.61
Chromium (µg/L)	0.07700	0.11158	0.18000	0.02653	24	0.24	0.05000	0.12138	0.22000	0.05548	32	0.46
Copper (µg/L)	0.2770	0.4292	0.8150	0.1457	24	0.34	0.3060	0.6721	1.3700	0.2892	32	0.43
Cyanide (µg/L)												
Lead (µg/L)	0.0050	0.0208	0.0842	0.0227	24	1.09	0.0050	0.0763	0.3270	0.0847	32	1.11
Mercury (µg/L)	0.000200	0.000241	0.000517	0.000082	24	0.34	0.000240	0.000843	0.001990	0.000508	32	0.60
Nickel (µg/L)	0.383	0.418	0.501	0.026	24	0.06	0.156	0.479	1.090	0.299	32	0.62
Silver (µg/L)	0.01000	0.01700	0.03300	0.00846	24	0.50	0.01000	0.01634	0.05240	0.01141	32	0.70
Zinc (µg/L)	0.300	0.631	1.020	0.235	24	0.37	0.460	1.029	2.160	0.407	32	0.40

Parameter	KSBP01 (Carkeek, West Pt)				LSNT01 (Alki)				LTED04 (Elliott West)				LTXQ01 (Henderson)			
	Min	Ave	Max	Count	Min	Ave	Max	Count	Min	Ave	Max	Count	Min	Ave	Max	Count
Alkalinity, Total (mg CaCO ₃ /L)					97	100	103	16								
Ammonia (mg/L as N)					0.0050	0.0188	0.0853	191								
Fecal Coliform (#/100 mL)	1	1	4	24	1	1	1	24	1	2	29	24	5	33	600	24
		(geomean)				(geomean)				(geomean)				(geomean)		
Total Suspended Solids (mg/L)	0.5	2.4	7.0	136	0.5	2.4	7.5	134	0.5	2.7	8.1	102	2.5	16	116	22
pH	7.5	7.7	8.0	108	7.4	7.6	8.0	112	7.4	7.6	8.0	84	6.8	7.1	7.3	16

Appendix E — Facility Data

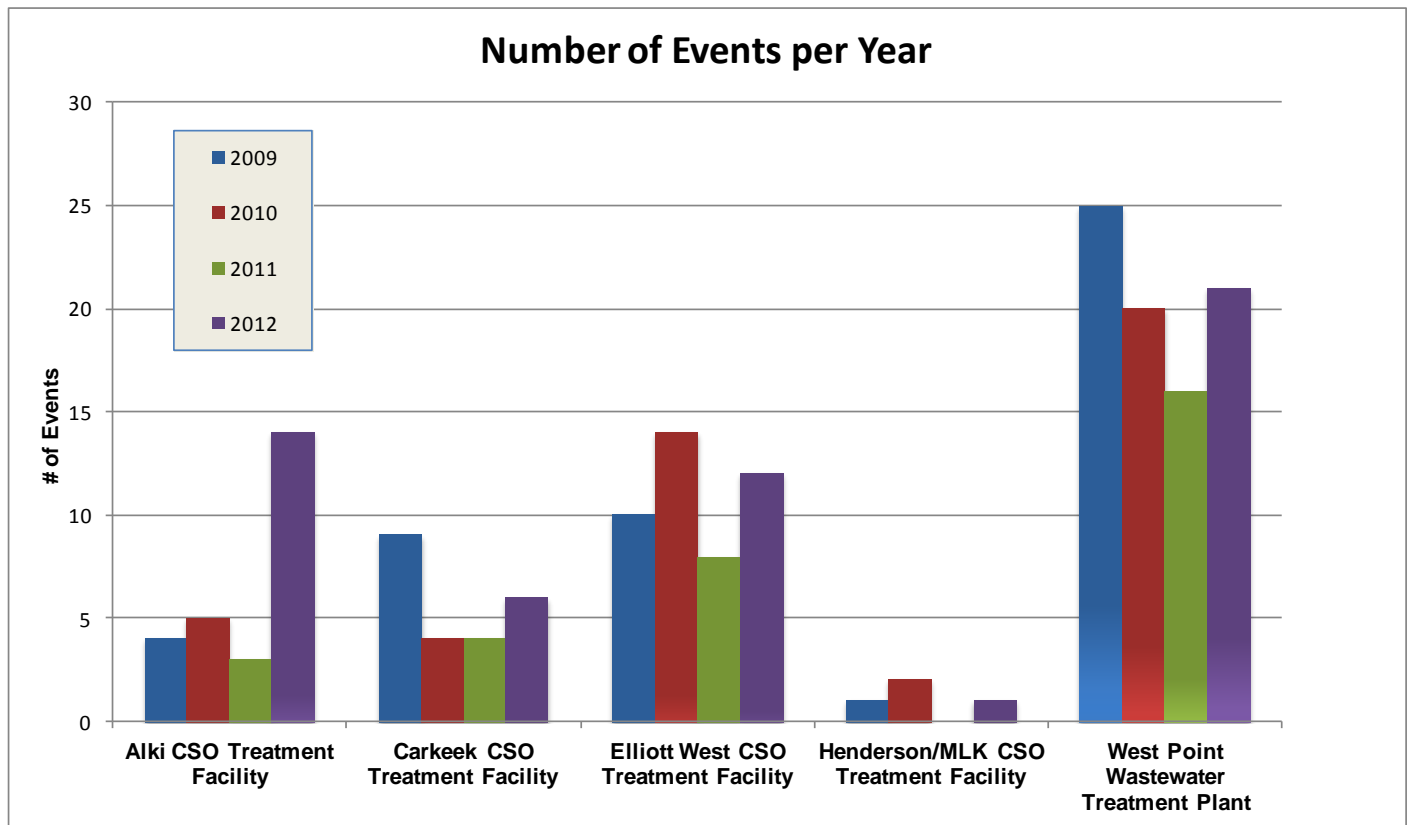
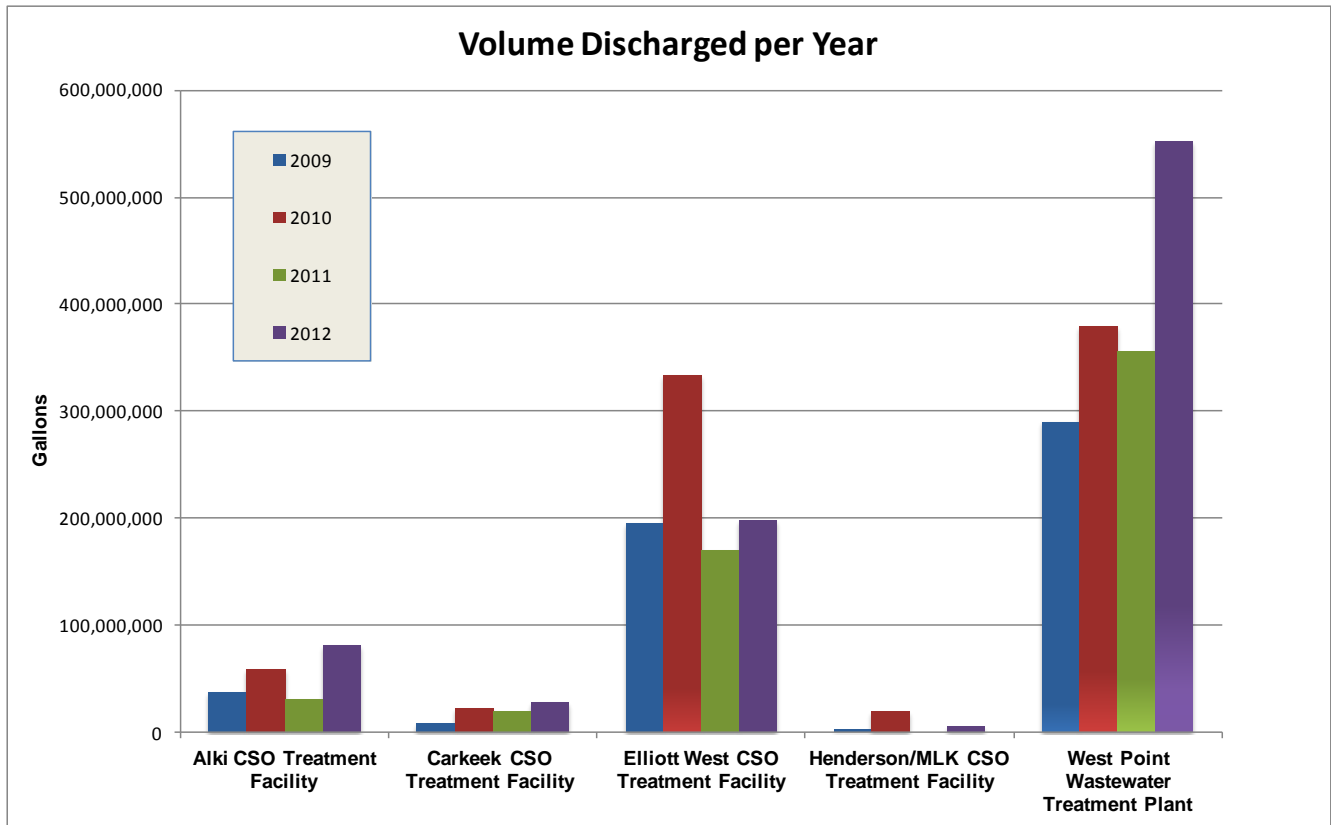

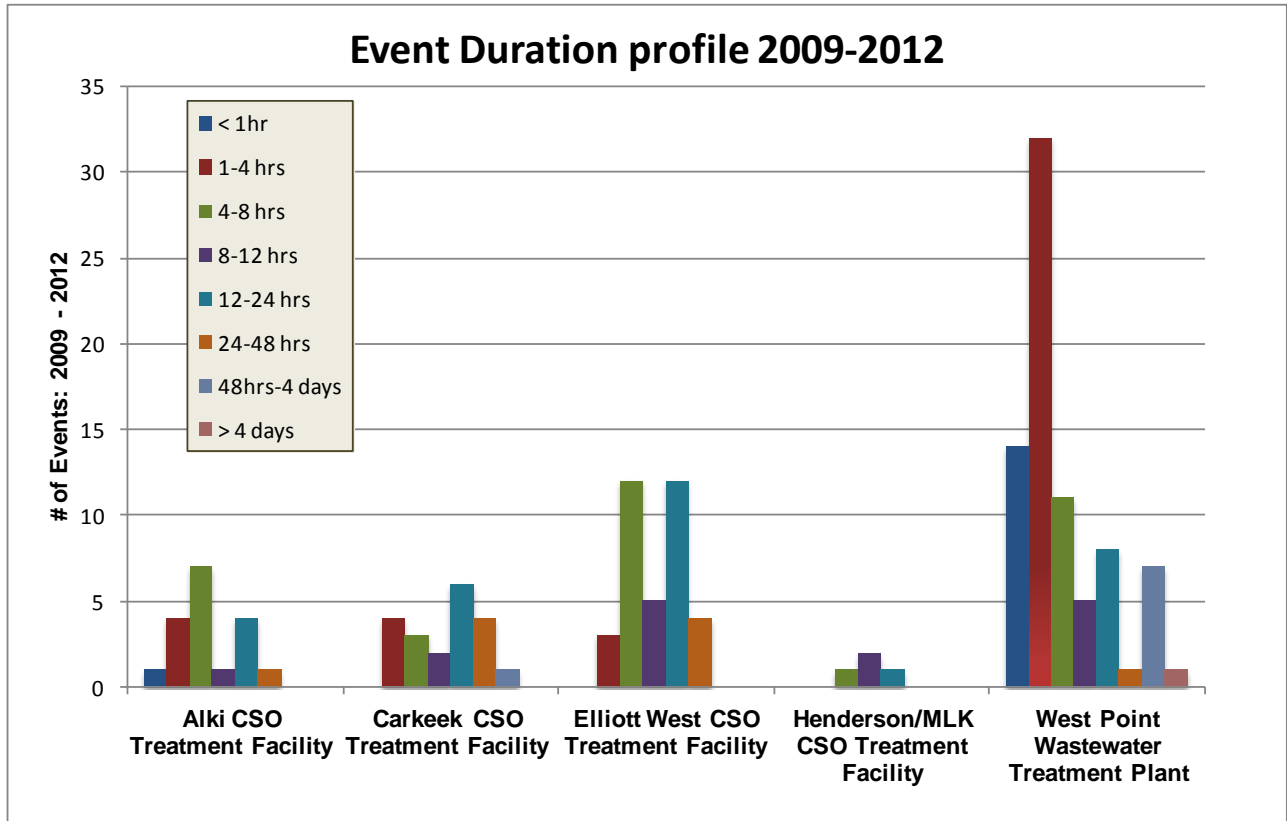

West Point WWTP – Plant Data

King County West Point Chronic WET Test Results

Test Code	Collected	Start Date	Organism	Endpoint	NOEC/LOEC in % Effluent		PMSD
					NOEC	LOEC	
RMAR2559	4/11/2012	4/11/2012	Atlantic mysid	7-day Survival	50	100	28.87%
				Biomass	25	50	27.44%
				Weight	25	50	21.92%
RMAR2558	4/11/2012	4/11/2012	topsmelt	7-day Survival	50	100	13.50%
				Biomass	25	50	16.35%
				Weight	25	50	18.23%
RMAR2761	10/3/2012	10/3/2012	Atlantic mysid	7-day Survival	50	100	16.14%
				Biomass	25	50	21.62%
				Weight	25	50	15.99%
RMAR2762	10/3/2012	10/3/2012	topsmelt	7-day Survival	50	100	8.20%
				Biomass	25	50	15.36%
				Weight	50	> 50	14.59%

King County West Point Acute WET Test Results

Test Code	Collected	Start Date	Organism	Endpoint	NOEC/LOEC in % Effluent			% Survival
					NOEC	LOEC	PMSD	
RMAR2431	1/10/2012	1/10/2012	<i>Daphnia pulex</i>	48-hour Survival	100	> 100	5.00%	100%
RMAR2430	1/10/2012	1/10/2012	fathead minnow	96-hour Survival	100	> 100	4.57%	100%
RMAR2615	7/17/2012	7/18/2012	<i>Daphnia pulex</i>	48-hour Survival	100	> 100	5.00%	100%
RMAR2616	7/17/2012	7/18/2012	fathead minnow	96-hour Survival	100	> 100	6.45%	98%

West Point Wastewater Treatment Plant and Combined Sewer Overflow System

West Point WWTP		Effluent - page 1															
	Flow, MGD	Flow, MGD	CBOD, lbs/day	CBOD, lbs/day	CBOD, mg/L	CBOD, mg/L	CBOD, % Removal	TSS, lbs/day	TSS, lbs/day	TSS, mg/L	TSS, mg/L	TSS, % Removal	Fecal Coliform, #/100 ml	Fecal Coliform, #/100 ml	pH	pH	
	Ave	Max Day	Mnth Ave	Wk Ave	Mnth Ave	Wkly Ave	Ave	Mnth Ave	Wk Ave	Mnth Ave	Wk Ave	Ave	GEM	GM7	max	min	
1-Jul-09	66	74	2700	3200	5	6	98	3500	3900	6.0	7.0	98	3	12	7.2	6.8	
1-Aug-09	71	110	3700	4600	6	7	97	4300	5200	7.0	9.0	97	4	14	7.2	6.8	
1-Sep-09	75	155	3400	4000	5	6	98	3600	4200	5.0	6.0	98	7	12	7.3	6.7	
1-Oct-09	90	239	4800	7000	7	8	96	5600	10000	7.0	10.0	97	5	14	7.5	6.5	
1-Nov-09	157	323	7310	11100	5	6	95	10800	16500	7.0	9.0	95	6	16	7.1	6.5	
1-Dec-09	95	198	3790	5330	4	5	97	5550	7910	6.0	7.0	97	6	17	7.5	6.5	
1-Jan-10	156	316	6360	12600	5	6	95	9750	18400	7.0	8.0	95	4	17	7.2	6.4	
1-Feb-10	112	237	5490	6280	5	6	96	9430	11600	9.0	11.0	95	2	4	7.0	6.5	
1-Mar-10	96	225	4350	6150	5	6	96	6820	9840	8.0	10.0	96	13	2	7.5	6.5	
1-Apr-10	99	199	4110	5510	5	5	97	5890	6960	7.0	7.0	97	5	8	7.4	6.6	
1-May-10	94	164	4310	5100	6	7	97	5550	6060	7.0	8.0	97	6	13	7.1	6.6	
1-Jun-10	92	166	4610	5160	6	7	97	6030	7090	8.0	8.0	97	11	25	7.3	6.5	
1-Jul-10	70	86	3800	3960	7	7	97	4050	4400	7.0	7.0	97	2	4	7.2	6.7	
1-Aug-10	71	116	3450	3710	6	6	97	4100	4230	7.0	7.0	97	2	2	7.1	6.7	
1-Sep-10	87	216	4560	6940	6	8	96	5210	7740	6.0	8.0	97	7	9	7.2	6.8	
1-Oct-10	90	243	13000	33200	14	27	92	21500	61300	21.0	45.0	92	7	42	7.3	6.6	
1-Nov-10	103	239	9130	17100	9	12	94	13300	26400	13.0	17.0	94	16	45	7.4	6.8	
1-Dec-10	153	404	7000	9540	5	7	95	13800	21800	9.0	12.0	93	6	15	7.2	6.3	
1-Jan-11	127	296	5520	9210	5	6	96	8560	14400	7.0	8.0	95	2	6	6.9	6.4	
1-Feb-11	107	240	5380	10200	5	8	96	7620	13400	8.0	10.0	96	2	4	7.8	6.6	
1-Mar-11	149	335	7900	14600	5	7	95	13700	30900	8.0	15.0	94	3	6	7.6	6.3	
1-Apr-11	108	200	5740	8970	6	9	96	6960	9070	8.0	9.0	96	2	3	7.5	6.3	
1-May-11	104	276	5150	6960	6	8	96	7040	9270	8.0	9.0	96	4	4	7.2	6.3	
1-Jun-11	92	131	4270	4830	6	6	97	5830	6860	8.0	9.0	97	9	24	7.2	6.6	
1-Jul-11	81	106	5540	6710	8	10	96	6240	7160	9.0	11.0	97	13	40	7.3	6.7	
1-Aug-11	76	81	4340	6300	7	10	97	5370	8200	8.0	13.0	97	14	26	7.6	6.8	
1-Sep-11	68	115	2750	3510	5	6	98	3080	4230	5.0	7.0	98	4	7	7.3	6.7	
1-Oct-11	76	171	5030	7090	8	10	96	7140	11000	11.0	18.0	96	6	33	7.3	6.5	
1-Nov-11	101	319	4670	9040	5	5	97	7770	17100	8.0	10.0	96	4	12	7.5	6.1	
1-Dec-11	77	176	5640	9610	9	12	95	8250	14500	12.0	18.0	95	5	19	7.6	6.5	
1-Jan-12	120	295	7340	12000	7	11	94	9870	13900	9.0	14.0	95	3	11	7.8	6.3	
1-Feb-12	98	186	5610	7340	7	8	95	8850	12600	10.0	14.0	94	2	4	7.0	6.2	
1-Mar-12	131	266	9770	16300	7	10	93	19400	36600	14.0	20.0	91	4	13	7.1	6.2	
1-Apr-12	92	135	4420	5070	6	7	96	5330	5790	7.0	8.0	97	2	2	7.1	6.4	
1-May-12	88	193	4570	5530	6	9	96	6220	7560	9.0	12.0	96	2	3	7.2	6.3	
1-Jun-12	86	166	7250	9910	10	11	95	8750	13000	12.0	14.0	95	3	4	7.7	6.6	
1-Jul-12	76	152	4310	5290	6	7	96	5480	6440	8.0	10.0	97	5	26	7.4	6.3	
1-Aug-12	65	79	3080	3810	6	6	97	3980	4810	7.0	9.0	97	14	29	7.5	6.7	
1-Sep-12	61	71	3510	4090	7	8	97	3130	3880	6.0	8.0	98	3	6	7.2	6.6	
1-Oct-12	93	299	6750	11500	8	10	96	8610	22100	9.0	14.0	97	10	43	7.3	6.1	
1-Nov-12	140	339	7100	12300	6	6	95	13500	27200	10.0	14.0	94	12	24	7.7	6.3	
1-Dec-12	175	340	7040	11400	4	6	95	13600	22100	8.0	11.0	94	8	25	7.3	6.1	
1-Jan-13	115	336	6370	8350	6	9	95	8600	11700	8.0	11.0	95	2	4	7.0	6.0	
1-Feb-13	86	121	3980	4970	5	6	97	5120	6050	7.0	8.0	97	2	4	7.1	6.5	
1-Mar-13	91	222	4210	5710	5	6	97	5340	6890	7.0	8.0	97	2	5	6.8	6.2	
1-Apr-13	108	247	4290	5640	5	5	97	6650	9650	7.0	7.0	96	2	2	6.9	6.2	
1-May-13	77	135	5130	6050	8	10	96	6200	7930	10.0	12.0	96	3	13	6.6	7.4	
1-May-13	77	135	5130	6050	8	10	96	6200	7930	10.0	12.0	96	3	13	6.6	7.4	
1-Jun-13	75	126	5270	6080	8	9	96	5520	8470	8.0	11.0	97	2	3	6.5	7.7	
1-Jul-13	65	69	3925	4693	7	9	97	3649	4409	7.0	8.0	98	4	7	7.3	6.7	
1-Aug-13	69	120	5855	7393	10	11	95	7622	11606	13.0	18.0	95	4	10	7.5	6.5	
1-Sep-13	85	220	4898	6353	7	9	96	9602	14987	12.0	14.0	96	7	26	7.3	6.6	
1-Oct-13	69	102	3414	5173	6	8	97	4188	7631	7.0	10.0	97	4	18	7.1	6.7	
AVE:	96	198	5302	7896	6	8	96	7580	12318	8.5	11.3	96	5	14	7.3	6.5	
MIN:	61	69	2700	3200	4	5	92	3080	3880	5.0	6.0	91	2	2	6.5	6.0	
MAX:	175	404	13000	33200	14	27	98	21500	61300	21.0	45	98	16	45	7.8	7.7	
Limits	215		44800	71700	25	40	85	53800	80700	30	45	85	200	400	6.0	9.0	
Nov-April							80					80					

West Point WWTP - Influent Data

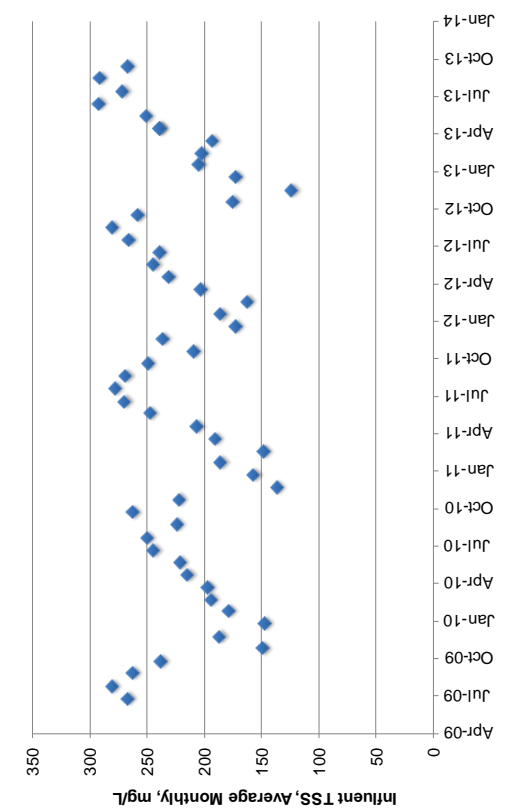
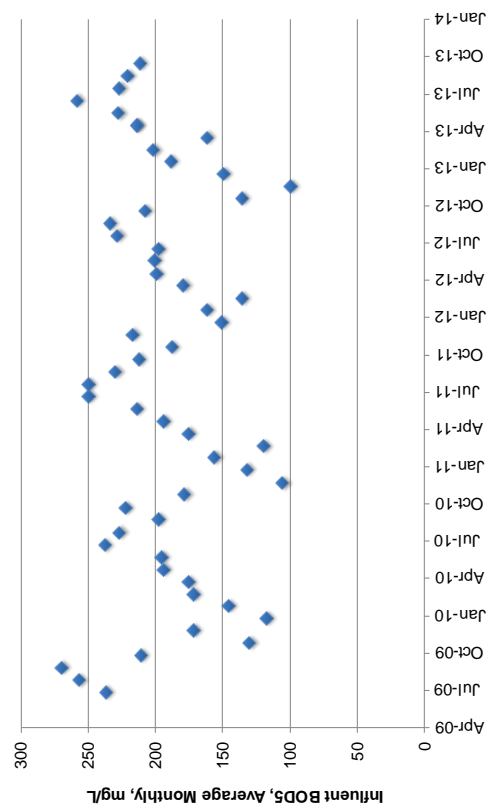
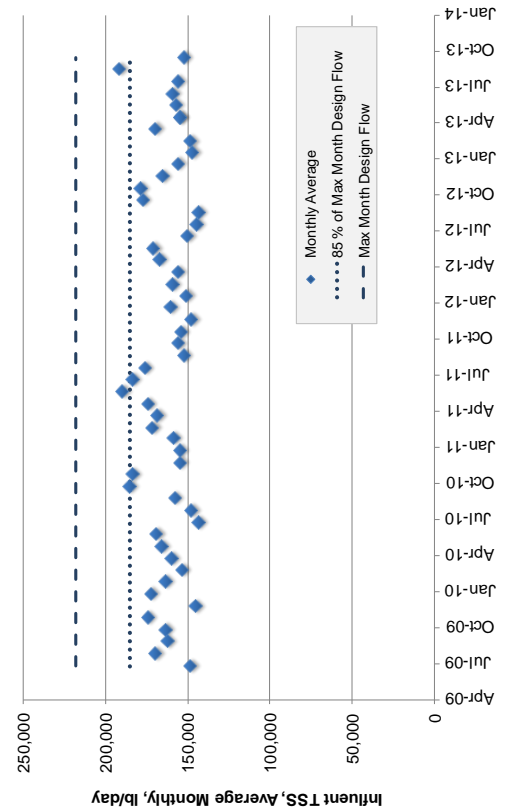
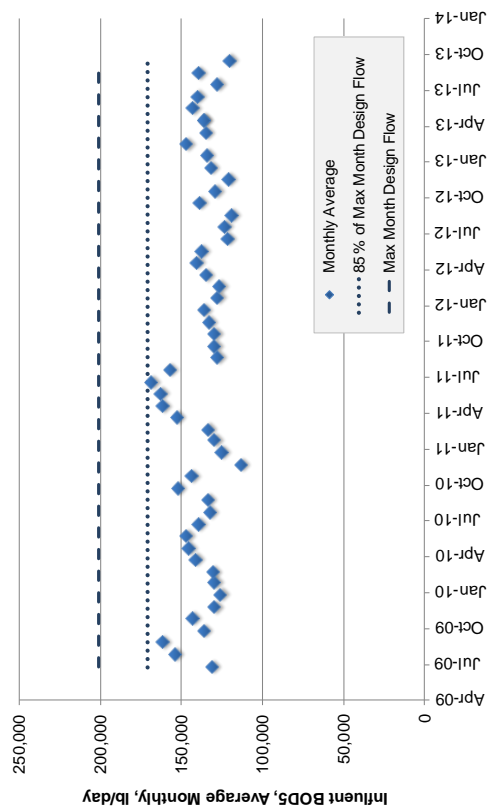

West Point WWTP - Effluent Data

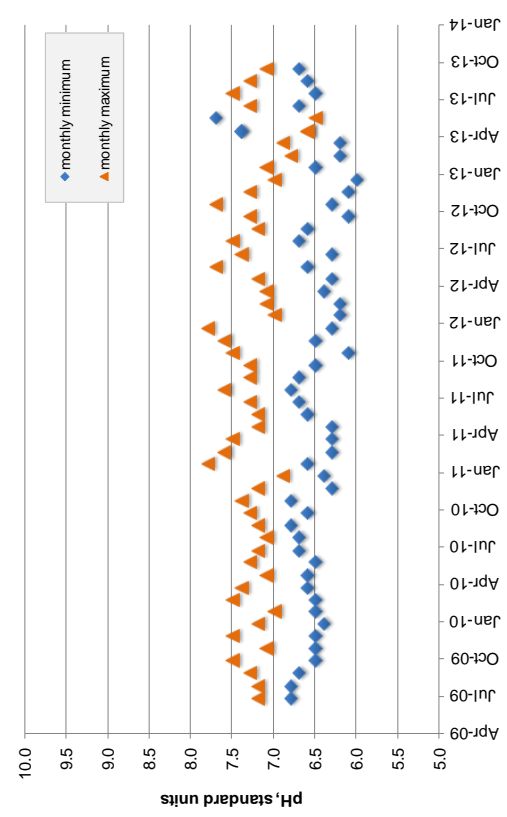
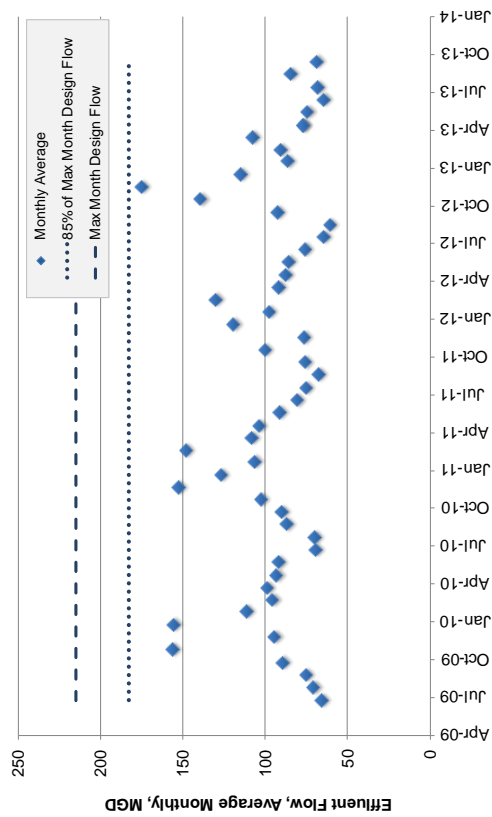
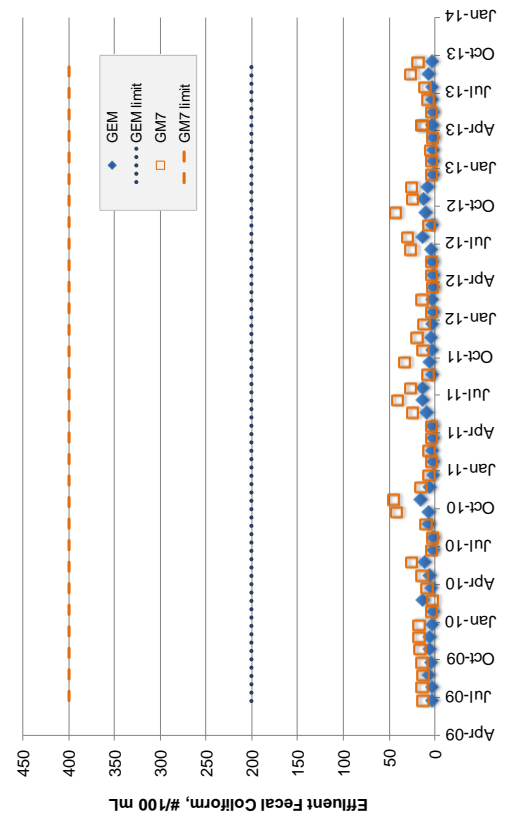
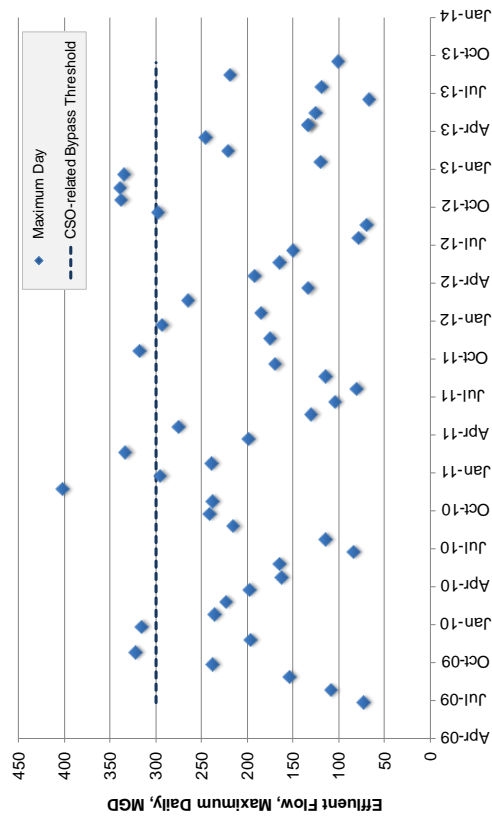

West Point WWTP - Effluent Data (continued)

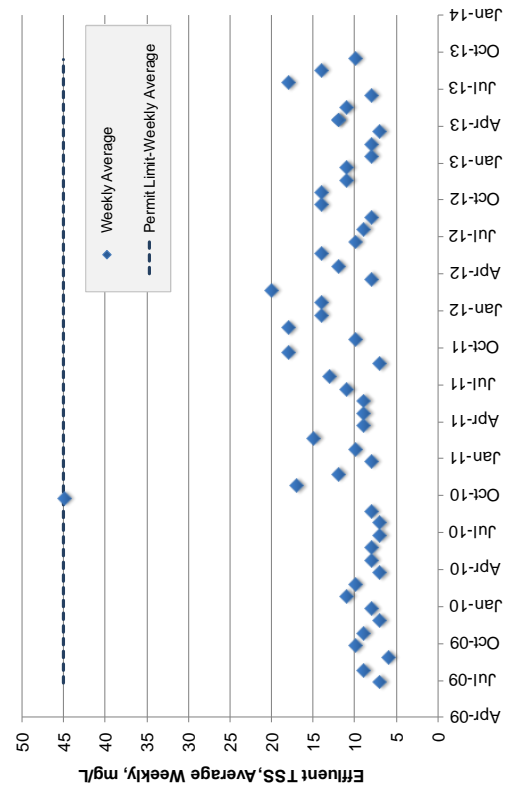
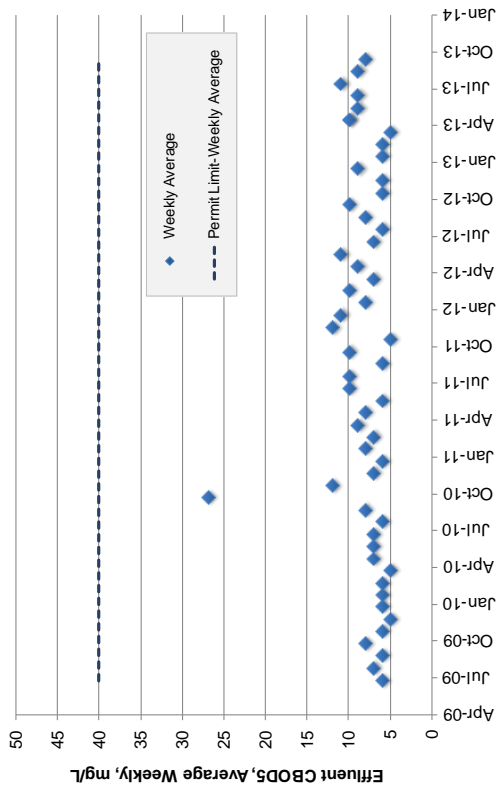
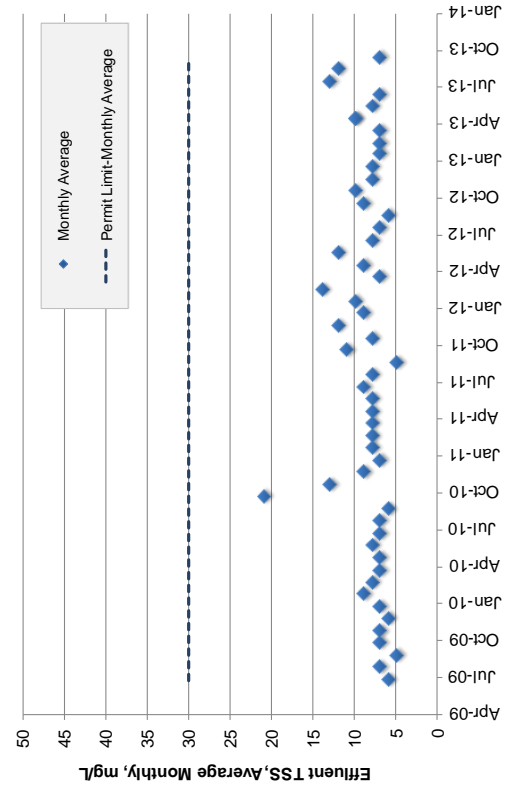
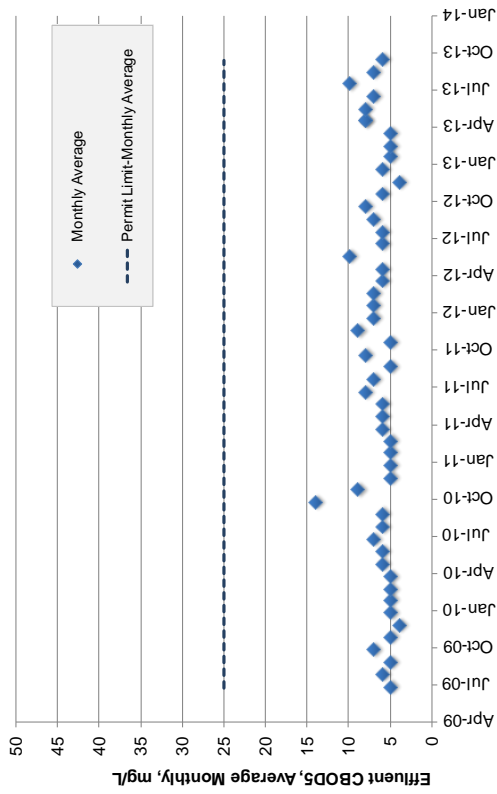

West Point WWTP - Effluent Data (continued)

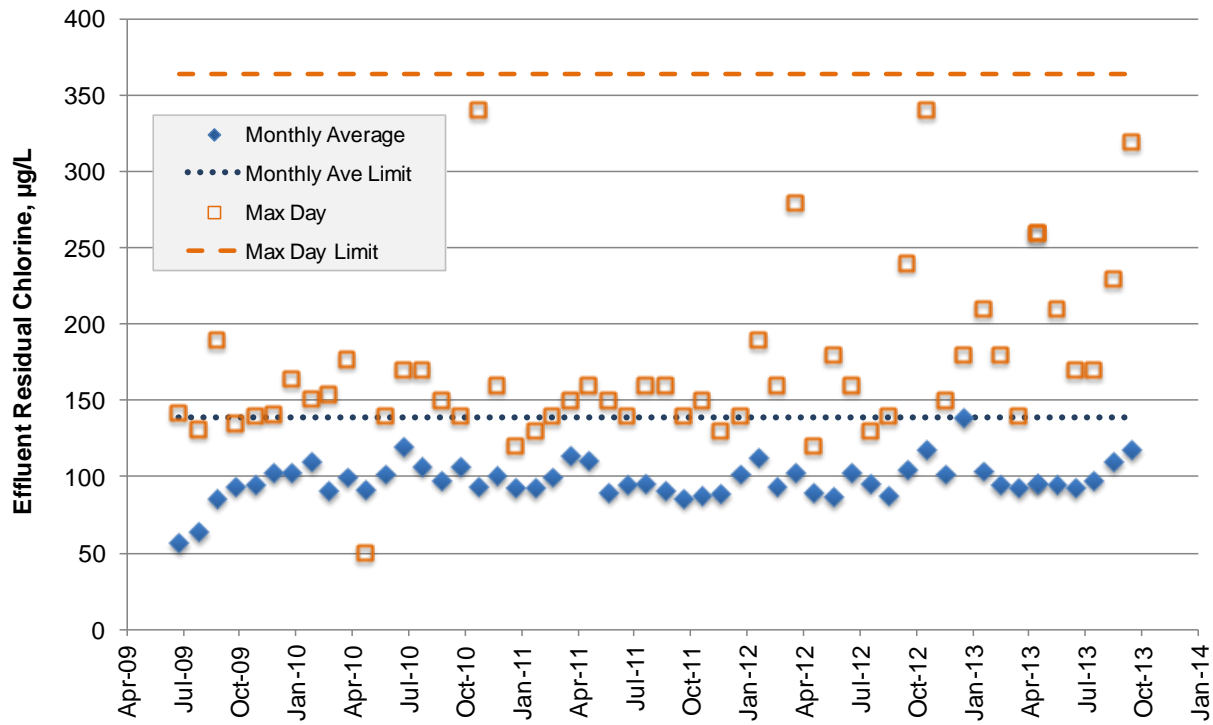

Alki CSO Treatment Plant – Plant Data

Alki CSO Treatment Plant DMR Data

Alki CSO Influent						Alki CSO Treatment Plant Effluent													
Alki CSO	Volume, MG	BOD, mg/L	BOD, mg/L	TSS, mg/L	TSS, mg/L	Volume, MG	BOD, mg/L	BOD, mg/L	TSS, mg/L	TSS, mg/L	TSS, % Removal	Fecal Coliform, #/100 ml	Fecal Coliform, #/100 ml	pH	pH	Res. Chlorine, µg/L	Res. Chlorine, µg/L	Settleable Solies, mL/L	Settleable Solies, mL/L
	Total	Ave	Max	Ave	Max	Total	Ave	Max	Ave	Max	Ave	GEM	Max	max	min	Ave	Day	Ave	Event
1-Sep-09	0.2	E	E	213	213	0.0	nd	nd	nd	nd	94	nd	nd	nd	nd	nd	nd	nd	nd
1-Oct-09	1.4	41	41	122	122	0.0	24	24	41	41	97	20,000	20,000	8.4	8.4	100	100	0.1	0.1
1-Nov-09	6.4	13	22	51	82	1.8	14	14	26	32	84	1	1	7.4	7.2	684	684	0.1	0.1
1-Jan-10	14.5	39	51	56	61	8.4	26	28	27	27	67	1	1	7.3	7.0	1092	1708	0.2	0.2
1-Mar-10	0.2	28	28	40	40	0.0	nd	nd	nd	nd	96	nd	nd	nd	nd	nd	nd	nd	nd
1-Sep-10	3.8	34	38	115	156	1.0	16	17	31	48	89	10	18	7.2	6.8	39	50	0.3	0.3
1-Oct-10	2.5	28	28	100	100	0.9	24	24	25	25	87	17	17	6.9	6.9	31	31	0.1	0.1
1-Nov-10	8.8	12	12	66	66	6.9	24	24	15	15	45	10	10	7.1	7.1	513	513	0.1	0.1
1-Dec-10	45.5	22	35	126	167	41.7	21	32	46	52	19	7	50	7.3	7.1	254	503	0.2	0.4
1-Jan-11	11.3	36	42	65	82	7.9	22	22	57	82	37	22	235	7.4	7.1	158	213	0.3	0.3
1-Mar-11	9.0	11	11	62	62	6.4	12	12	37	37	52	1	1	7.2	7.2	227	227	0.3	0.3
1-May-11	2.1	70	70	97	97	0.0	nd	nd	nd	nd	86	nd	nd	nd	nd	nd	nd	nd	nd
1-Nov-11	21.3	51	72	125	166	16.7	27	29	25	28	61	18,150	18,150	7.3	7.3	38	38	0.1	0.1
1-Jan-12	16.1	45	51	32	36	12.7	22	28	24	26	31	2157	2157	7.4	7.4	28	28	0.1	0.1
1-Oct-12	9.3	27	27	54	54	6.7	14	18	13	20	65	56	56	6.2	6.2	34	34	0.2	0.2
1-Nov-12	50.7	>28	57	91	188	41.6	17	29	30	60	60	35	77	6.3	6.3	66	87	0.2	0.6
1-Dec-12	32.3	37	61	101	214	20.4	35	51	40	82	59	99	800	6.7	6.0	17	49	0.2	0.4
1-Jan-13	12.9	93	93	60	60	5.7	40	40	44	44	51	45	45	7.4	6.0	0	0	0.2	0.2
1-Sep-13	12.2	28	42	108	142	7.4	25	36	65	68	56	173	30,000	6.8	5.8	30	40	0.6	0.7
AVE:	13.7	36	43	89	111	9.8	23	27	34	43	65	2,549	4,476	7.1	6.9	207	269	0.2	0.3
MIN:	0.2	11	11	32	36	0.0	12	12	13	15	19	1	1	6.2	5.8	0	0	0.1	0.1
MAX:	50.7	93	93	213	214	41.7	40	51	65	82	97	20,000	30,000	8.4	8.4	1092	1708	0.6	0.7
5th %tile:																			
95th %tile:						36	43												
85%																			
Limits thru June 09												1,700		-	-		290		1.9
Limits 7/09-present												400		9.0	6.0		234		1.9

nd - No Discharge

Exceeds Permit Limit

Annual Reporting for the Alki CSO Treatment Facility

Year	Number of Inflow Events	Inflow Volume, Annual Total, MG	Number of Discharge Events	Discharge Volume, Annual Total, MG	Settleable Solids, Annual Average, mL/L	TSS, Annual Average % Removal
2009	10	49	4	37	0.3	62
2010	6	75	5	59	0.3	68*
2011	4	44	3	31	0.3	55
2012	7	108	7	81	0.2	57
Total	27	276	19	209		
Average			5	52		
Limits	-	-	29	108	0.3	> 50%

* Omits 1 event from calculation

Volume Diverted, MG 67

Alki CSO Treatment Plant - Influent vs. Effluent

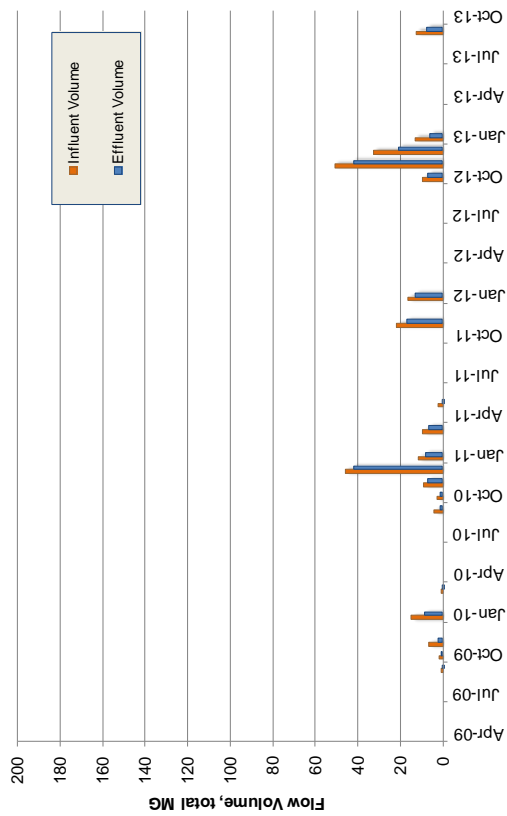
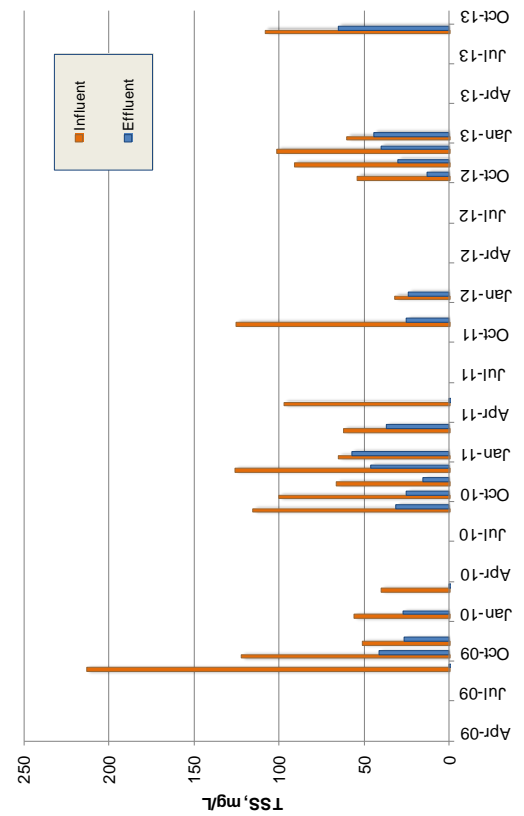
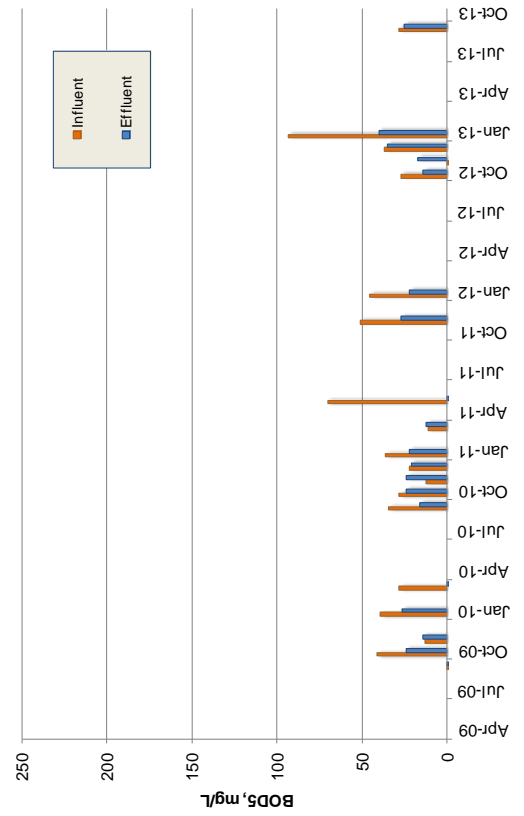

Alki CSO Treatment Plant - Effluent Data

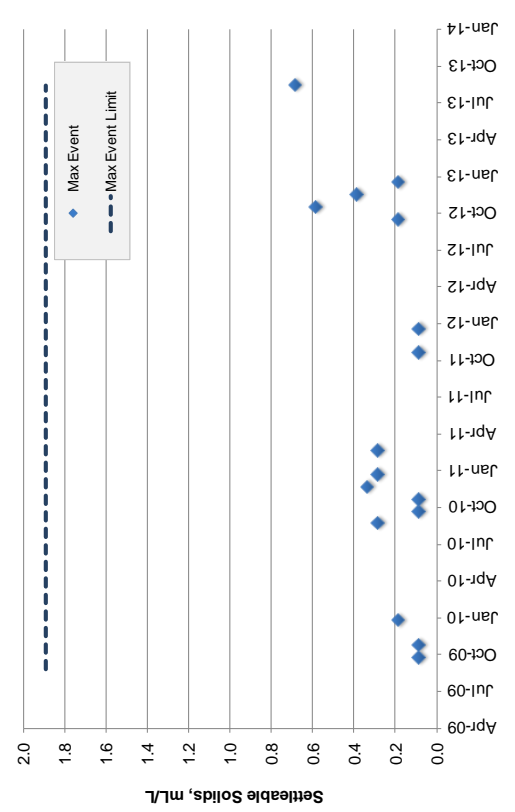
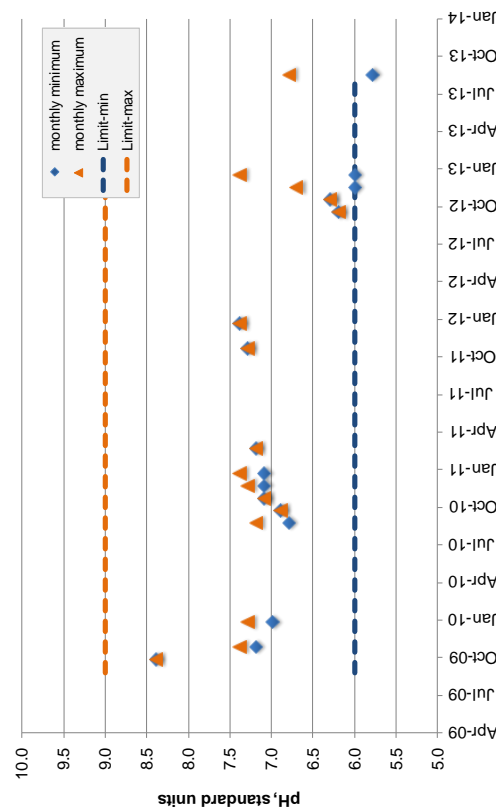
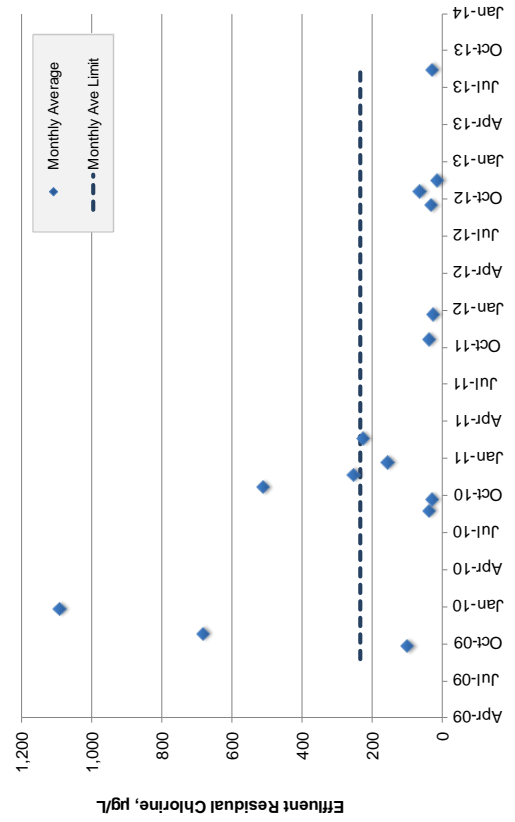
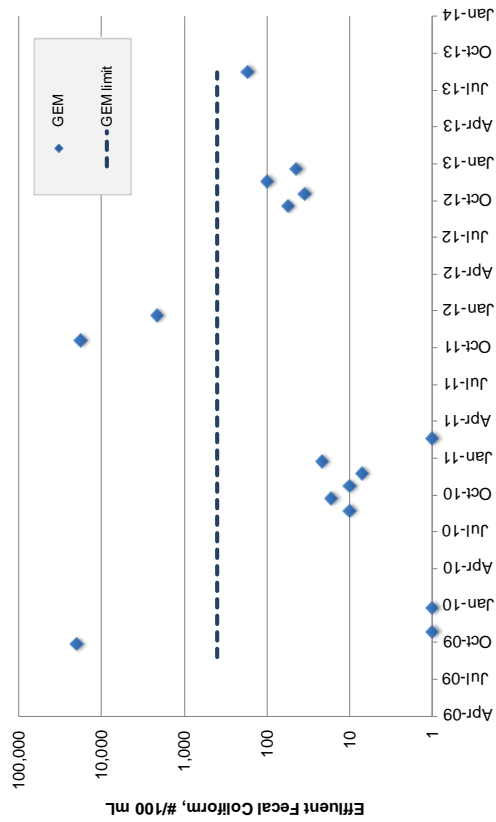

Carkeek CSO Treatment Plant – Plant Data

Carkeek CSO Treatment Plant DMR Data

Carkeek CSO Influent						Carkeek CSO Treatment Plant Effluent													
	Volume, MG	BOD, mg/L	BOD, mg/L	TSS, mg/L	TSS, mg/L	Volume, MG	BOD, mg/L	BOD, mg/L	TSS, mg/L	TSS, mg/L	TSS, % Removal	Fecal Coliform, #/100 ml	Fecal Coliform, #/100 ml	pH	pH	Res. Chlorine, µg/L	Res. Chlorine, µg/L	Settleable Solids, mL/L	Settleable Solids, mL/L
	Total	Ave	Max	Ave	Max		Total	Mnth Ave	Mnth Max	Mnth Ave	Mnth Max	Ave	GEM	Max	max	min	Mnth Ave	Max Day	Mnth Ave
1-Sep-09	0.4	97	132	215	297	0.1	132	132	132	132	84	nd	nd	nd	nd	nd	nd	nd	nd
1-Oct-09	0.6	75	87	154	195	0.0	nd	nd	nd	nd	94	nd	nd	nd	nd	nd	nd	nd	nd
1-Nov-09	8.6	52	86	75	201	5.7	38	61	36	124	65	27	17,000	7.9	6.9	344	448	0	0.5
1-Jan-10	2.6	97	128	130	184	4.8	31	32	22	24	70	755	13,000	7.1	6.9	26	53	0	0.1
1-Mar-10	0.0	99	99	117	117	0.0	nd	nd	nd	nd	96	nd	nd	nd	nd	nd	nd	nd	nd
1-May-10	0.1	148	148	251	251	0.0	nd	nd	nd	nd	96	nd	nd	nd	nd	nd	nd	nd	nd
1-Sep-10	0.0	392	392	603	603	0.0	nd	nd	nd	nd	91	nd	nd	nd	nd	nd	nd	nd	nd
1-Nov-10	1.0	658	658	1,016	1,016	0.0	nd	nd	nd	nd	55	nd	nd	nd	nd	nd	nd	nd	nd
1-Dec-10	18.3	52	116	108	368	16.1	20	37	46	156	13	752	80,000	7.5	6.6	374	1370	0	1.4
1-Jan-11	1.9	76	100	68	111	1.3	40	48	56	81	24	1	1	6.9	6.9	18	22	0	0.1
1-Feb-11	0.1	43	43	141	141	0.0	nd	nd	nd	nd	86	nd	nd	nd	nd	nd	nd	nd	nd
1-Mar-11	16.3	39	62	59	121	15.1	18	37	30	48	37	8	5,000	7.7	6.0	233	475	0	0.5
1-Jul-11	0.1	264	264	620	620	0.0	nd	nd	nd	nd	97	nd	nd	nd	nd	nd	nd	nd	nd
1-Nov-11	2.6	76	103	92	114	2.0	23	27	19	24	66	1	1	6.7	6.7	102	130	0	0.1
1-Jan-12	0.2	81	121	101	141	0.0	nd	nd	nd	nd	90	nd	nd	nd	nd	nd	nd	nd	nd
1-Mar-12	0.5	113	172	325	551	0.0	nd	nd	nd	nd	43	nd	nd	nd	nd	nd	nd	nd	nd
1-Jul-12	0.1	99	104	150	152	0.0	nd	nd	nd	nd	93	nd	nd	nd	nd	nd	nd	nd	nd
1-Oct-12	1.0	98	124	148	180	0.2	11	11	22	22	81	1	1	7.1	6.3	94	94	0.1	0.1
1-Nov-12	18.5	511	20	82	180	17.4	17	33	21	51	44	1	1	6.9	6.3	178	723	0	0
1-Dec-12	11.0	57	90	71	99	9.2	24	41	18	27	59	20	20	7.9	5.1	159	474	0	0
1-Jan-13	1.0	94	94	109	109	0.7	47	47	30	30	64	55	55	7.7	6.2	8	8	0	0
1-Apr-13	0.2	39	44	95	133	0.0	nd	nd	nd	nd	97	nd	nd	nd	nd	nd	nd	nd	nd
1-Sep-13	1.4	124	220	225	447	0.9	49	49	123	123	49	0	1	7.9	7.7	70	70	0.5	0.5
AVE:	3.8	147	148	215	275	3.2	38	46	46	70	69	147	10,462	7.4	6.5	146	352	0	0
MIN:	0.0	39	20	59	99	0.0	11	11	18	22	13	0	1	6.7	5.1	8	8	0	0
MAX:	18.5	658	658	1,016	1,016	17.4	132	132	132	156	97	755	80,000	7.9	7.7	374	1370	1	1.4
5th %tile:																			
95th %tile:																			
85%																			
Limits thru June 09												2,800		-	-		490		1.9
Limits 7/09-present												400		9.0	6.0		490		1.9

Exceeds Permit Limit

Annual Reporting for the Carkeek CSO Treatment Facility

Year	Number of Inflow Events	Inflow Volume, Annual Total, MG	Number of Discharge Events	Discharge Volume, Annual Total, MG	Settleable Solids, Annual Average, mL/L	TSS, Annual Average % Removal
2009	14	14	9	8.1	0.2	75.8
2010	11	25	4	21	0.2	67.8*
2011	8	21	4	18	0.1	65.7*
2012	17	31	6	27	0.1	50.1*
Total	50	91	23	74		
Average			6	19		
Limits		-	10	46	0.3	> 50%

* Omits 1 event from calculation

Volume Diverted, MG 17

Carkeek CSO Treatment Plant - Influent vs. Effluent

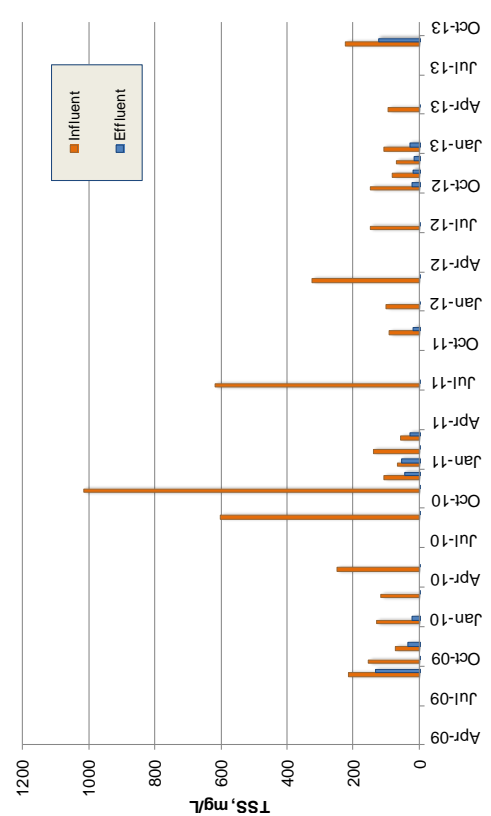
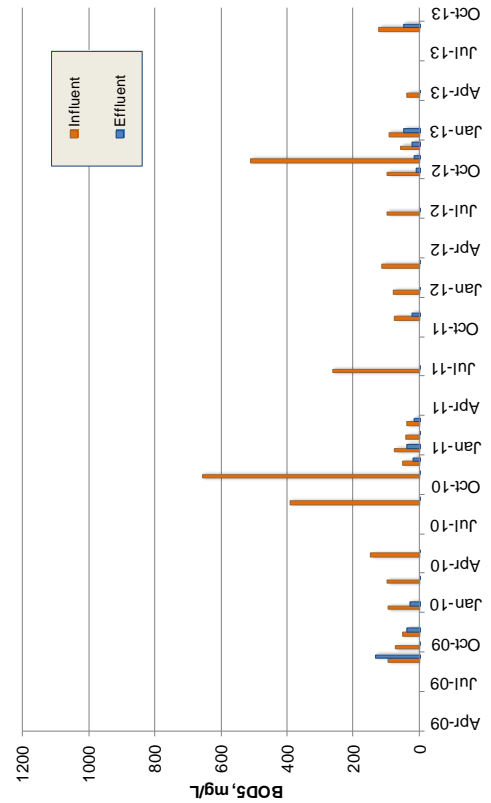
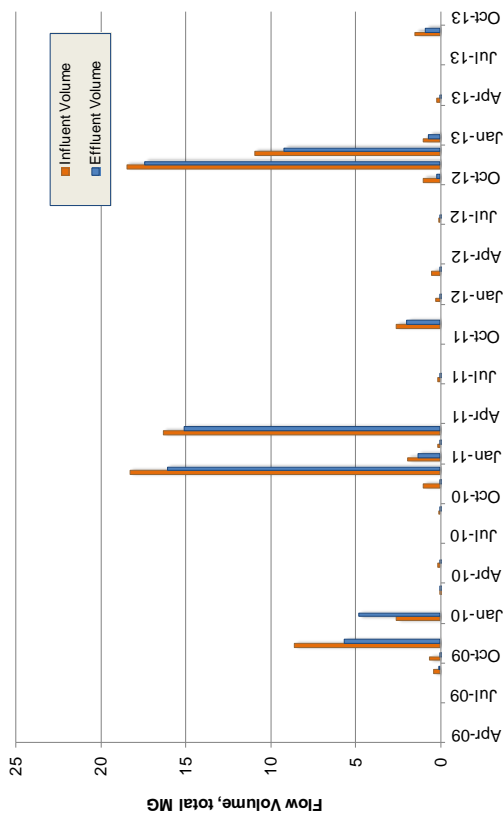

Carkeek CSO Treatment Plant - Effluent Data

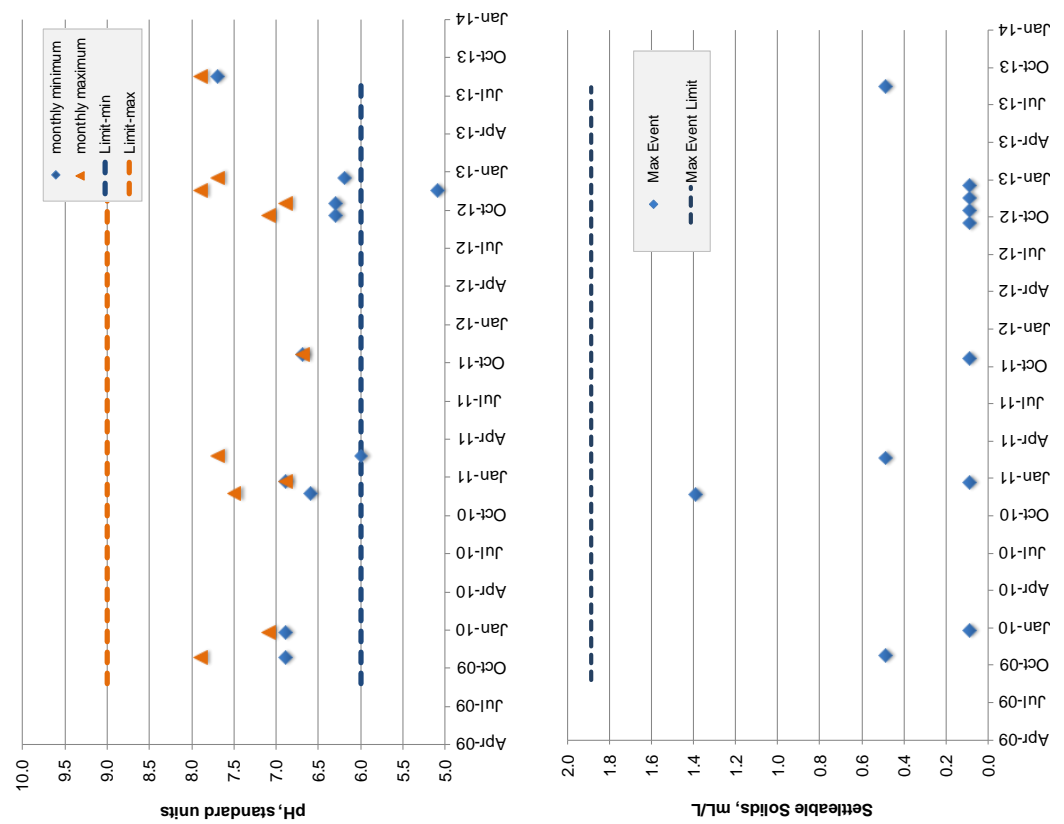
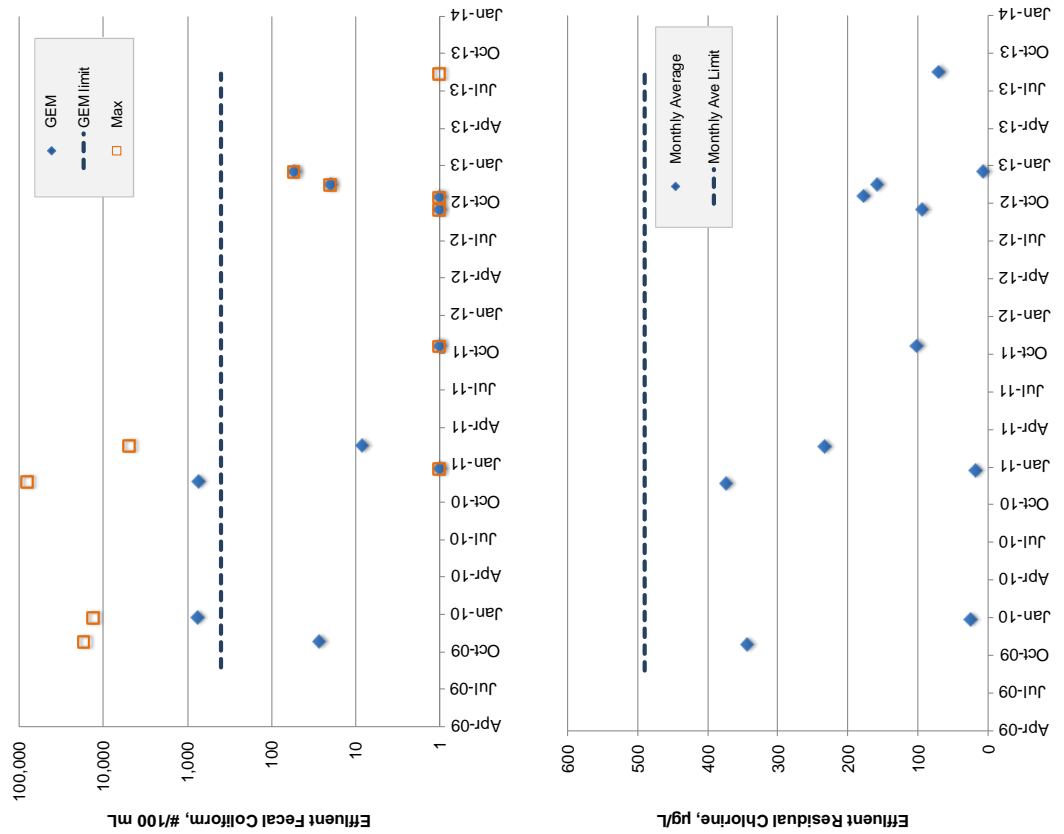

Elliott West CSO Treatment Plant – Plant Data

Elliott West CSO Treatment Plant DMR Data

Elliott West CSO TP	Influent					Effluent														
	Volume, MG	BOD, mg/L	BOD, mg/L	TSS, mg/L	TSS, mg/L	Volume, MG	BOD, mg/L	BOD, mg/L	TSS, mg/L	TSS, mg/L	TSS, % Removal	Fecal Coliform, #/100 ml	Fecal Coliform, #/100 ml	pH	pH	Res. Chlorine, µg/L	Res. Chlorine, µg/L	Settleable Solies, mL/L	Settleable Solies, mL/L	
																				Total
1-Oct-09	90.5	16	159	15	171	29.1	99	187	69	171	37	5,889	412,510	6.7	6.4	61	69	4.0	6.0	
1-Nov-09	141	30	135	52	397	87.5	38	59	67	151	28	51	150,250	e	e	e	e	5.0	10.0	
1-Dec-09	14.6	18	170	22	201	14.6	71	170	84	201	93	nd	nd	nd	nd	nd	nd	nd	nd	
1-Jan-10	103	34	365	49	494	58.9	52	99	73	131	37	220	2,875	7.5	6.9	21	53	4.0	9.0	
1-Feb-10	12.3	44	327	64	488	0.0	nd	nd	nd	nd	nd	nd	nd	nd	nd	nd	nd	nd	nd	
1-Mar-10	27.1	112	294	288	890	21.4	110	294	286	890	73	339	115,085	6.6	6.6	28	28	0.6	0.9	
1-Apr-10	25.1	54	710	154	2,035	16.4	122	710	342	2035	71	0	0	6.7	6.7	18	18	2.0	2.0	
1-May-10	9.1	23	126	63	467	0.0	nd	nd	nd	nd	97	nd	nd	nd	nd	nd	nd	nd	nd	
1-Jun-10	4.5	87	273	170	660	0.0	nd	nd	nd	nd	96	nd	nd	nd	nd	nd	nd	nd	nd	
1-Aug-10	1.8	107	107	66	66	0.0	nd	nd	nd	nd	95	nd	nd	nd	nd	nd	nd	nd	nd	
1-Sep-10	57.3	52	122	189	675	38.3	37	80	90	159	15	5,099	400,000	7.2	6.9	1	2	1.4	2.0	
1-Oct-10	51.8	151	845	394	2,250	27.9	34	37	60	96	47	316	2,500	6.9	6.6	3	8	0.8	1.5	
1-Nov-10	54.5	92	244	186	778	26.2	57	57	81	96	54	2,439	7,000	6.9	6.6	8	16	1.4	2.5	
1-Dec-10	200	77	636	143	1,945	32.7	191	654	342	1945	60	41	5,000	7.0	6.6	25	158	0.2	0.5	
1-Jan-11	57.5	48	86	70	242	24.7	58	185	98	496	61	0	0	6.9	6.7	0	0	0.1	0.1	
1-Feb-11	42.4	139	403	143	453	38.3	141	403	151	453	92	45	45	6.7	6.7	2	2	0.1	0.1	
1-Mar-11	71.7	134	627	706	4,320	41.4	139	627	708	4320	80	553	1,300	6.5	6.5	3	8	0.2	0.5	
1-Apr-11	17.5	119	267	126	372	14.4	120	267	129	372	80	20	20	5.5	5.5	2	2	0.1	4.5	
1-May-11	29.8	60	175	77	161	15.3	64	175	88	271	67	400,000	400,000	6.4	6.2	1	2	1.2	1.7	
1-Jul-11	0.6	62	112	171	322	0.0	nd	nd	nd	nd	97	nd	nd	nd	nd	nd	nd	nd	nd	
1-Sep-11	1.8	107	107	66	66	0.0	nd	nd	nd	nd	nd	nd	nd	nd	nd	nd	nd	nd	nd	
1-Oct-11	3.1	58	132	246	726	0.0	nd	nd	nd	nd	95	nd	nd	nd	nd	nd	nd	nd	nd	
1-Nov-11	110	77	214	164	435	83.7	20	22	94	124	28	1	10	6.8	6.7	94	94	0.8	0.9	
1-Dec-11	18.4	66	74	72	104	1.7	74	74	104	104	78	17,000	17,000	7.9	7.9	259	259	0.1	0.1	
1-Jan-12	68.9	51	104	152	760	30.3	47	73	44	56	64	2	30,000	6.7	6.6	77	231	0.4	0.9	
1-Feb-12	9.7	165	492	353	1,006	0.0	nd	nd	nd	nd	92	nd	nd	nd	nd	nd	nd	nd	nd	
1-Mar-12	63.9	391	4,418	313	3,058	18.0	31	32	100	110	56	1	1,100	6.8	6.5	33	76	1.2	1.4	
1-Apr-12	1.6	134	219	189	348	0.0	nd	nd	nd	nd	97	nd	nd	nd	nd	nd	nd	nd	nd	
1-May-12	15.9	58	90	108	262	0.0	nd	nd	nd	nd	96	nd	nd	nd	nd	nd	nd	nd	nd	
1-Jun-12	11.9	66	114	95	169	0.0	nd	nd	nd	nd	91	nd	nd	nd	nd	nd	nd	nd	nd	
1-Jul-12	20.5	102	132	295	535	7.8	110	110	315	315	55	1	40	6.5	6.5	59	59	5.5	5.5	
1-Oct-12	54.7	34	66	71	187	27.0	30	42	31	43	62	1	1	6.1	5.7	69	103	0.1	0.2	
1-Nov-12	135	64	478	172	1,195	97.4	22	36	86	203	31	64	335	6.3	5.7	40	102	0.2	0.3	
1-Dec-12	66.6	40	202	62	206	18.4	32	43	59	121	57	40	50	7.6	5.8	165	407	1.3	3.7	
1-Jan-13	30.6	39	128	55	104	18.4	39	42	35	38	31	40	40	6.4	5.9	0	0	1.4	1.4	
1-Mar-13	20.5	46	113	102	274	10.1	30	30	54	54	52	20	40	8.0	6.0	280	435	1.4	2.0	
1-Apr-13	21.9	26	81	65	282	5.2	8	8	10	10	92	70	70	8.0	5.9	50	50	0.1	0.1	
1-May-13	3.2	37	62	229	574	0.0	nd	nd	nd	nd	96	nd	nd	nd	nd	nd	nd	nd	nd	
1-Jun-13	10.0	98	107	86	133	0.0	nd	nd	nd	nd	93	nd	nd	nd	nd	nd	nd	nd	nd	
1-Sep-13	58.4	30	63	88	189	37.4	36	43	90	108	41	26	700	8.5	6.1	607	860	1.2	2.5	
1-Oct-13	2.1	4	4	25	25	0.0	nd	nd	nd	nd	96	nd	nd	nd	nd	nd	nd	nd	nd	
Ave:	42.5	77	331	150	684	20.5	67	169	137	484	69	16,626	59,460	6.9	6.4	76	122	1.3	2.3	
MIN:	0.6	4	4	15	25	0.0	8	8	10	10	15	0	0	5.5	5.5	0	0	0.1	0.1	
MAX:	200	391	4,418	706	4,320	97.4	191	710	708	4320	97	400,000	412,510	8.5	7.9	607	860	5.5	10.0	
5th %tile:																				
95th %tile:																				
85%																				
Limits thru June 09												400	-	-		44			1.9	
Limits 7/09-5/11												400	9.0	6.0		104			1.9	
Limits 6/11-present												154	9.0	6.0		104			1.9	

nd - No Discharge

Exceeds Permit Limit

Elliott West CSO Treatment Plant - Influent vs. Effluent

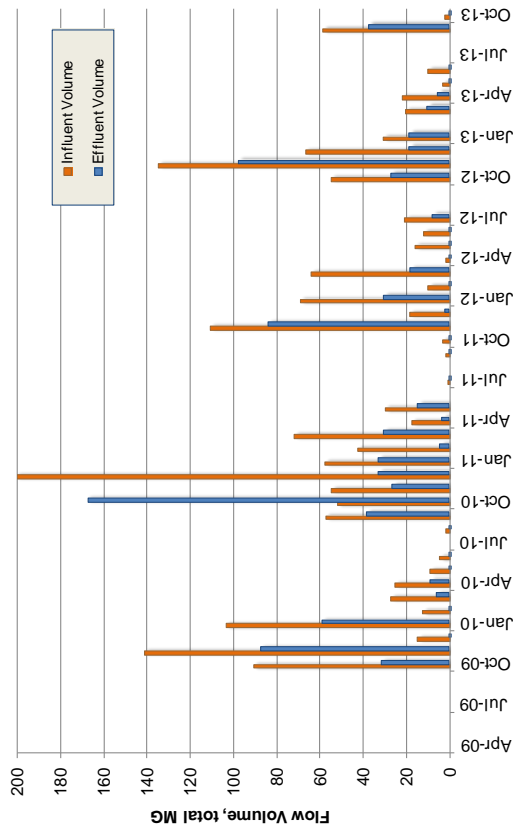
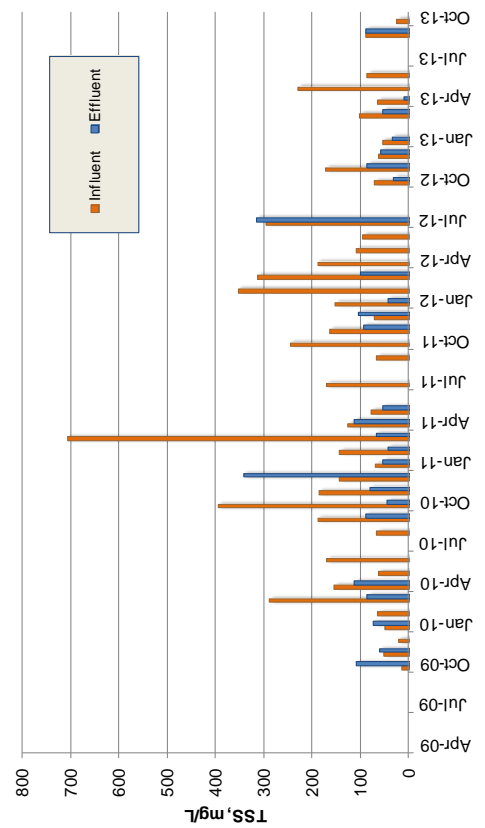
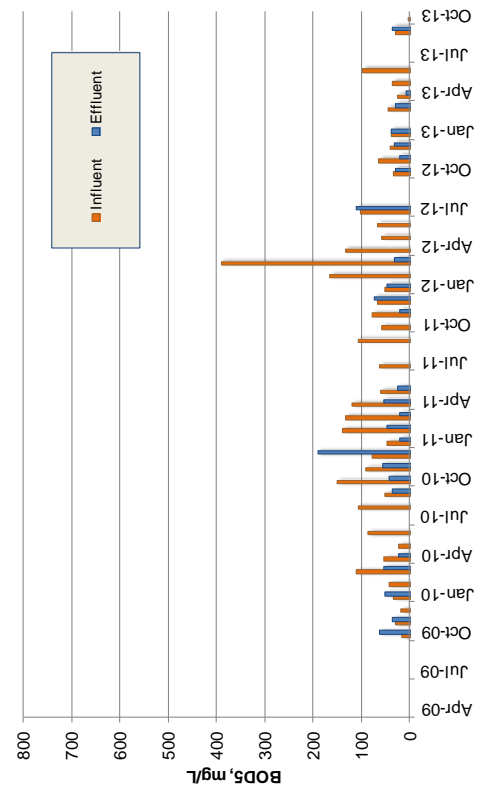

Elliott West CSO Treatment Plant - Effluent Data

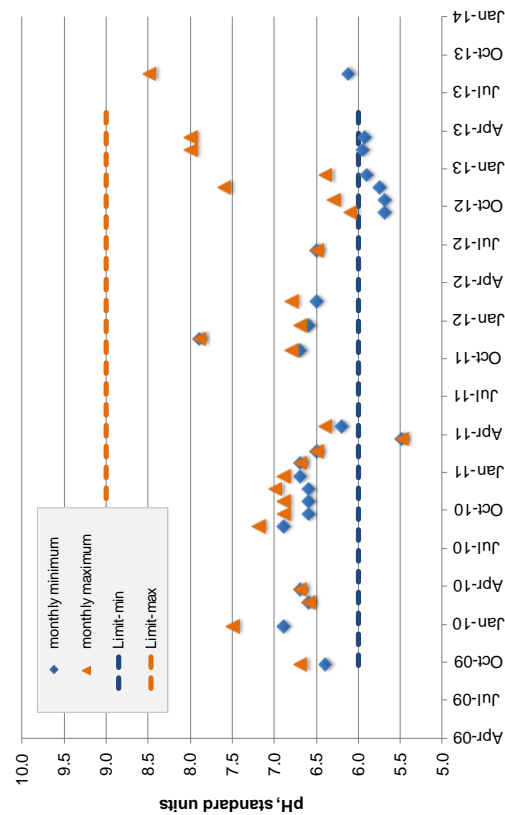
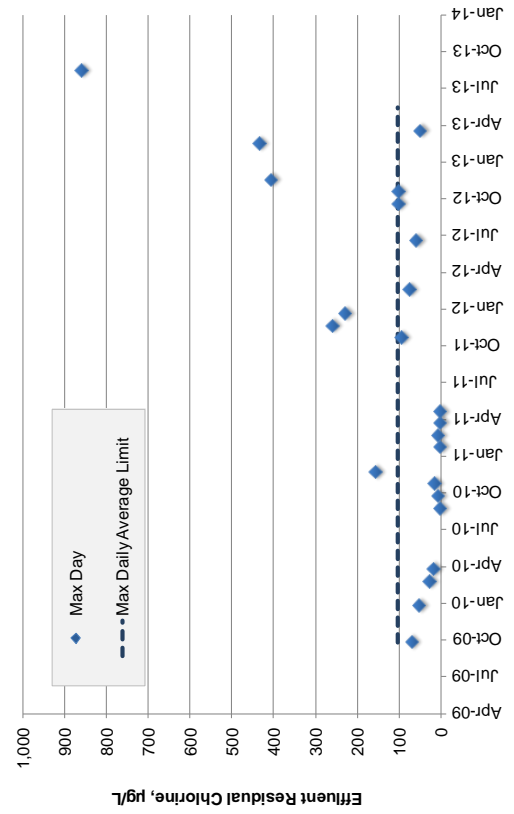
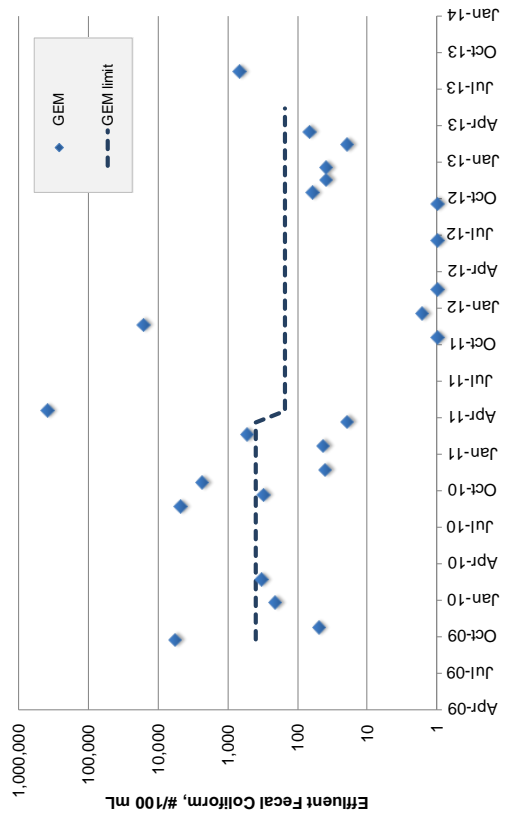

Annual Reporting for the Elliott West CSO Treatment Facility

Year	Number of Inflow Events	Inflow Volume, Annual Total, MG	Number of Discharge Events	Discharge Volume, Annual Total, MG	Settleable Solids, Annual Average, mL/L	TSS, Annual Average % Removal
2009	24	371	10	196	2.3	41.6*
2010	47	547	15	333	1.5	53.3
2011	41	357	8	170	0.8	62.4
2012	46	512	12	199	1.15	64.5*
Total	158	1787	45	898		
Limits	-	-	-	-	0.3	> 50%

* Omits 1 event from calculation

Exceeds Permit Limit

Volume Diverted, MG	889
----------------------------	------------

Henderson / MLK CSO Treatment Plant – Plant Data

Henderson CSO Treatment Plant DMR Data

Henders on CSO	Influent					Effluent													
	Volume, MG	BOD, mg/L	BOD, mg/L	TSS, mg/L	TSS, mg/L	Volume, MG	BOD, mg/L	BOD, mg/L	TSS, mg/L	TSS, mg/L	TSS, % Removal	Fecal Coliform, #/100 ml	Fecal Coliform, #/100 ml	pH	pH	Res. Chlorine, µg/L	Res. Chlorine, µg/L	Settleable Solies, mL/L	Settleable Solies, mL/L
	Total	Ave	Max	Ave	Max	Total	Ave	Max	Ave	Max	Ave	GEM	Max	max	min	Ave	Day	Ave	Max
1-Jan-09	5.3	32	32	38	38	1.6	5	5	45	45	61	16	44	6.8	6.7	35	35	0.1	0.1
1-Jan-10	0.3	30	30	37	37	0.0	nd	nd	nd	nd	95	nd	nd	nd	nd	nd	nd	nd	nd
1-Oct-10	5.9	24	24	40	40	2.1	16	16	40	40	90	302,667	302,667	6.7	6.7	20	20	0.1	0.1
1-Nov-10	1.4	45	45	104	104	0.0	nd	nd	nd	nd	55	nd	nd	nd	nd	nd	nd	nd	nd
1-Dec-10	20.8	17	21	70	84	16.6	8	8	31	39	41	1	1	7.0	7.0	13	13	0.1	0.1
1-Mar-11	1.8	20	20	78	78	0.0	nd	nd	nd	nd	91	nd	nd	nd	nd	nd	nd	nd	nd
1-Jan-12	0.5	32	32	30	30	0.0	nd	nd	nd	nd	75	nd	nd	nd	nd	nd	nd	nd	nd
1-Mar-12	1.6	24	24	84	84	0.0	nd	nd	nd	nd	89	nd	nd	nd	nd	nd	nd	nd	nd
1-Nov-12	12.0	3	28	36	73	5.2	16	16	37	37	59	2	2	6.8	6.8	218	218	0.1	0.1
1-Jan-13	2.6	21	21	51	51	0.0	nd	nd	nd	nd	79	nd	nd	nd	nd	nd	nd	nd	nd
1-Sep-13	0.1	9	9	36	36	0.0	nd	nd	nd	nd	95	nd	nd	nd	nd	nd	nd	nd	nd
AVE:	4.7	23	26	55	60	2.3	11	11	38	40	75	75,672	75,679	6.8	6.8	72	72	0.1	0.1
MIN:	0.1	3	9	30	30	0.0	5	5	31	37	41	1	1	6.7	6.7	13	13	0.1	0.1
MAX:	20.8	45	45	104	104	16.6	16	16	45	45	95	302,667	302,667	7.0	7.0	218	218	0.1	0.1
5th %tile:																			
95th %tile:																			
85%																			
Limits thru June 09												400		-	-		39		1.9
Limits 7/09-present												400		9.0	6.0		39		1.9

nd - No Discharge

Exceeds Permit Limit

Annual Reporting for the Henderson / MLK CSO Treatment Facility

Year	Number of Inflow Events	Inflow Volume, Annual Total, MG	Number of Discharge Events	Discharge Volume, Annual Total, MG	Settleable Solids, Annual Average, mL/L	TSS, Annual Average % Removal
2009	2	5.4	1	1.6	0.1	61
2010	4	28	2	19	0.1	59*
2011	1	1.8	0	0	-	91
2012	5	14	1	5.2	0.1	64
Total	12	50	4	26		
Limits	-	-	-	-	0.3	> 50%

* Omits 1 event from calculation

Volume Diverted, MG 24

Henderson/MLK CSO Treatment Plant - Influent vs. Effluent

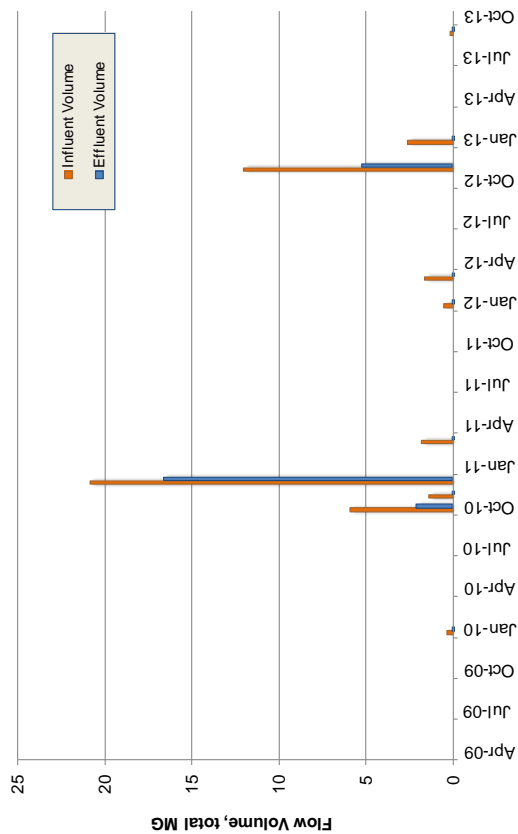
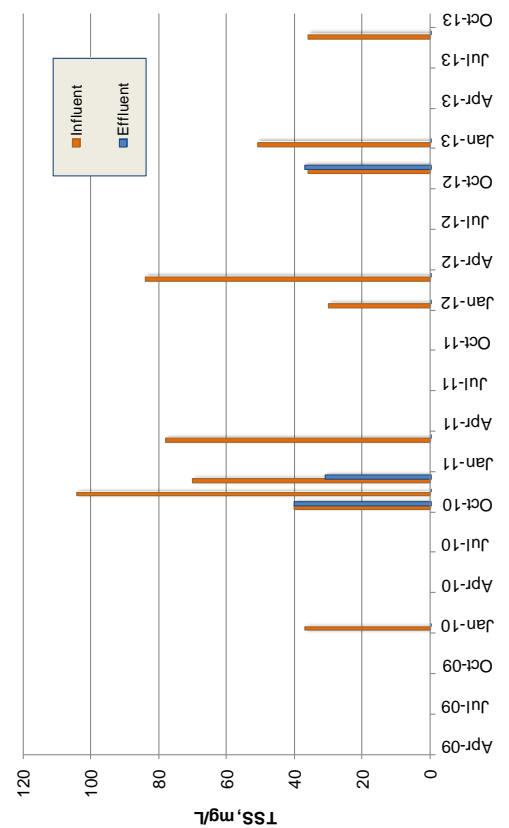
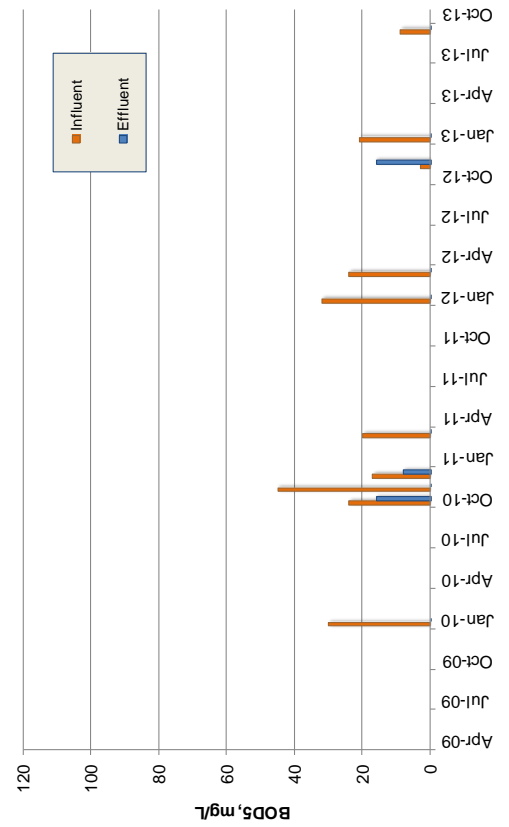

Henderson/MLK CSO Treatment Plant - Effluent Data

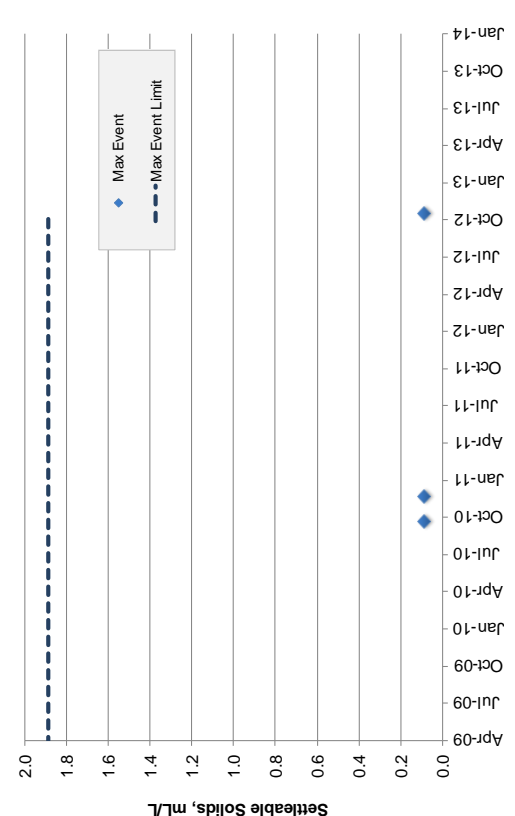
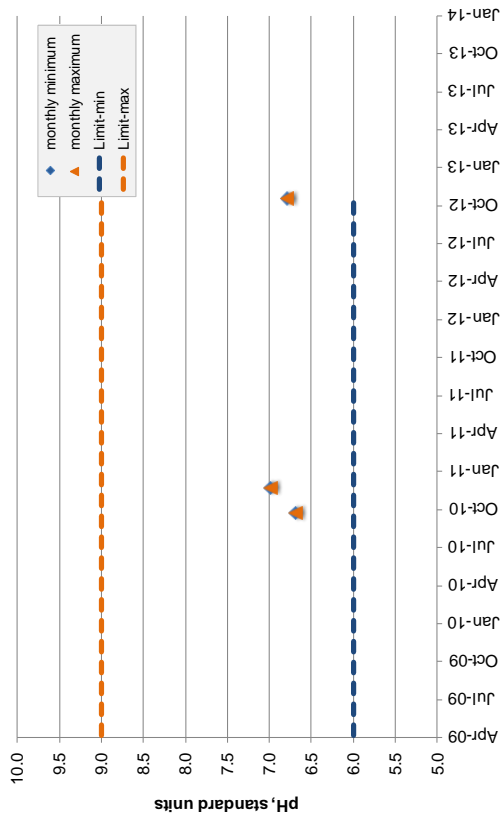
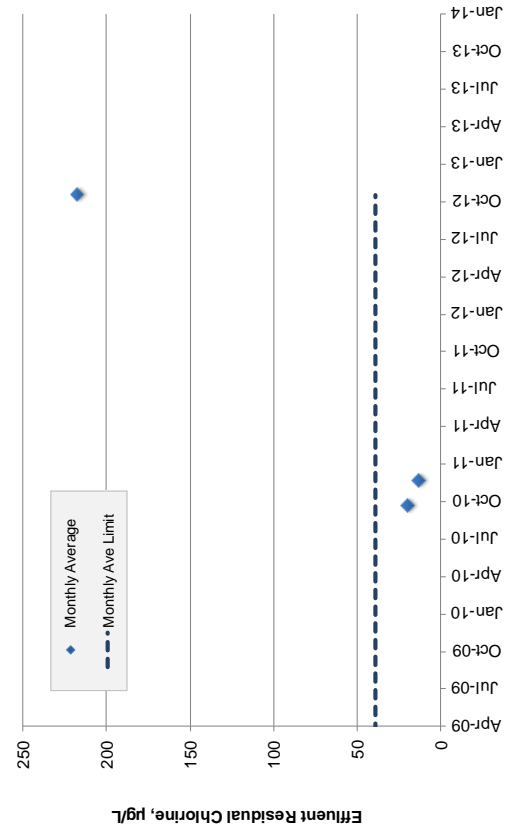
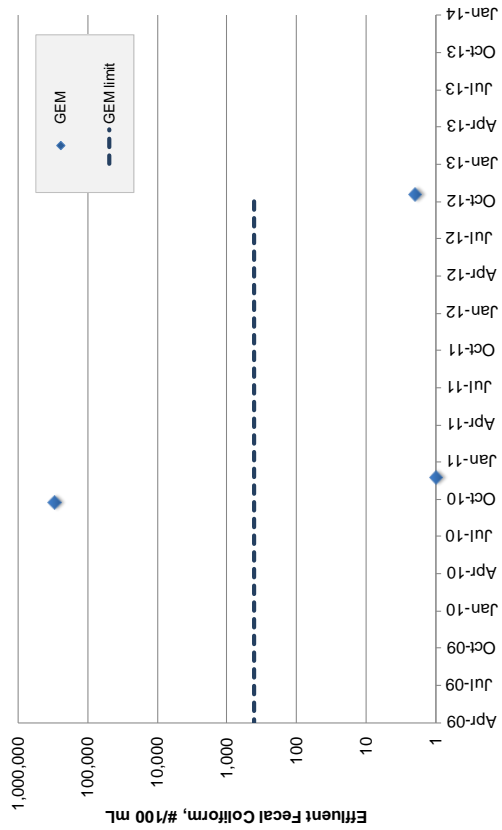

Untreated CSO Discharges - Data

CSO Outfall Name	Number of CSO Events per CSO Outfall - King County											
	1983 Baseline	2006	2007	2008	2009	2010	2011	2012	2013	2014	2015	2016
006 - Magnolia Overflow	25	18	22	26	25	38	22	36				
030 - Lander St. Regulator	26	18	8	6	19	17	15	25				
032 - Hanford #2 Regulator	28	16	12	8	17	18	15	23				
004 - East Ballard (AKA 11th Ave NW)	16	14	10	7	16	19	16	20				
048a - North Beach Pump Station (wet well)	18	9	4	4	14	10	15	20				
048b - North Beach Pump Station (inlet structure)	30	11	6	3	13	6	8	13				
031a - Hanford #1 (Hanford @ Rainier)						13	13	18				
031b - Hanford #1 (Bayview S.)						5	2	7				
031c - Hanford #1 (Bayview N.)												
031 - Hanford #1 Overflow		16	3	6	14							
014 - Montlake Overflow	6			1	3	9	8	18				
039 - Michigan Regulator (AKA S. Michigan Regulator)	34	9	6	3	10	12	14	16				
003 - Ballard Siphon Regulator via Seattle Storm Drain	13	3	2	1	8	6	7	13				
009 - Dexter Ave Regulator	15	12	9	3	11	13	8	13				
008 - 3rd Ave W and Ewing St	17	6	6	3	9	8	7	13				
036 - Chelan Ave. Regulator	7	2	2			3	4	13				
015 - University Regulator	13	7	5	3	9	8	6	13				
028 - King Street Regulator	16	17	7	3	15	18	15	13				
041 - Brandon Street Regulator	36			3	16	11	7	12				
029 - Connecticut St. Regulator (AKA Kingdome)	29	4	5	1	8	6	2	11				
056 - Murray Street Pump Station	5	7	4	3	11	9	3	5				
042 - West Michigan (AKA SW Michigan St regulator)	5	6	4	3	8	11	3	5				
057 - Barron Street Pump Station	9	5	3	2	2	4	1	4				
054 - 63rd Avenue SW Pump Station	2					1	1	3				
037 - Harbor Avenue Regulator	30	3	2			1	1	3				
012 - Behoir Pump Station Emergency Overflow	1	1	1			2	1	1				
052 - 53rd Avenue SW Pump Station	1	2	1	1				1				
055 - SW Alaska Street Overflow	1	1	1	1		1	1	1				
038 - Terminal 115 Overflow	4	5	4		3	3		1				
007 - Canal Street Overflow	1	1	1		1	1	1	1				
027a - Denny Way Regulator	32	7	1	2	4	2	2	1				
035 - W. Duwamish Pump Station	1		1			1		1				
040 - 8th Ave South Regulator (AKA W. Marginal Way Pump Station)	6					1		1				
018 - Matthews Park Pump Station Emergency Overflows	1					1		1				
034 - E. Duwamish Pump Station	1					1		1				
Total Number of Untreated Events	429	199	131	89	236	259	196	324				
Annual Precipitation, Inches	42.8	31.1	24.9	31.46	40.30	32.20	42.57					

West Point Wastewater Treatment Plant and Combined Sewer Overflow System

Annual Discharge Volume (gallons) per CSO Outfall - King County

CSO Outfall Name	2006	2007	2008	2009	2010	2011	2012
030 - Lander St. Regulator	128,641,103	120,537,575	33,623,696	355,927,868	502,565,171	223,304,825	524,435,439
032 - Hanford #2 Regulator	111,251,187	65,598,493	23,939,993	36,341,949	138,189,415	215,148,888	333,413,251
015 - University Regulator	56,040,237	198,223,235	6,545,240	61,898,794	135,381,902	48,815,940	105,058,388
031a - Hanford #1 (Hanford @ Rainier)	6,660,296	98,799,925	105,226	12,434,895	126,186,674	32,703,434	89,941,019
039 - Michigan Regulator (AKA S. Michigan Regulator)			407,251	8,716,113	65,427,370	22,015,836	75,982,142
014 - Montlake Overflow			1,898,700	24,149,925	38,715,418	9,821,972	47,750,378
041 - Brandon Street Regulator			229,293	3,544,686	9,991,516	418,810	47,429,418
029 - Connecticut St. Regulator (AKA Kingdome)	17,595,651	28,557,622	903,054	8,914,906	13,179,721	8,548,291	18,486,212
004 - East Ballard (AKA 11th Ave NW)	10,265,362	23,489,433			21,288,198	5,961,131	16,678,543
037 - Harbor Avenue Regulator	8,814,345	28,053,235			13,211,184	7,330,397	12,016,886
036 - Chelan Ave. Regulator	67,675	4,505,684			163,806	22,589,128	11,208,348
048a - North Beach P Pump Station (wet well)	679,242	7,327,646	6,531	283,130	4,627,555	1,554,706	11,018,376
054 - 63rd Avenue SW Pump Station			17,435,792	6,061,884	12,250,169	8,840,437	9,755,097
006 - Magnolia Overflow	56,893,112	56,564,669	3,598,264	8,124,651	15,109,389	967,316	9,146,016
009 - Dexter Ave Regulator	8,252,560	28,999,995	10,311,939	50,497,793	54,917,734	5,761,039	8,613,011
056 - Murray Street P Pump Station	11,077,241	107,410,187	815,653	56,238,166	32,775,036	16,053,502	7,865,932
028 - King Street Regulator	28,095,389	25,375,911			6,624,140	310,862	4,586,194
031c - Hanford #1 (Bayview N.)	913,746	42,074,066	1,743,583	10,578,307	25,025,932	5,795,081	4,381,473
008 - 3rd Ave W and Ewing St	208,237	576,388	112,078	682,846	3,902,200	2,887,006	4,338,033
048b - North Beach P Pump Station (inlet structure)	1,809,606	3,186,749		474,681	2,664,881	684,735	3,390,864
042 - West Michigan (AKA SW Michigan St regulator)	24,188,105	12,620,362	779,492	157,392	965,905	129,652	1,985,628
057 - Barton Street Pump Station	3,927,165	5,364,475		1,146,469	3,900,369		1,937,500
038 - Terminal 115 Overflow	465,296	910,538	32,518	660,812	1,433,199	1,118,148	1,668,118
003 - Ballard Siphon Regulator via Seattle Storm Drain	148,476	4,089,303			4,778,145		864,797
012 - Behvoir Pump Station Emergency Overflow							667,100
031b - Hanford #1 (Bayview S.)	36,804	1,274,529	99,965				588,004
052 - 53rd Avenue SW Pump Station		1,019,018		418,355	1,123,622		18,819
007 - Canal Street Overflow	55,114	2,285			23,495	19,148	8,063
055 - SW Alaska Street Overflow	57,562,597	29,065,200	81,495	953,306	11,125	50,613	580
027a - Denny Way Regulator		10,096,325			6,067,408		
034 - E. Duwamish Pump Station					6,600,000		
018 - Matthews Park Pump Station Emergency Overflows					35,911		
035 - W. Duwamish Pump Station		6,268,539			18		
040 - 8th Ave South Regulator (AKA W. Marginal Way Pump Station)							
031 - Hanford #1 Overflow	36,100,125	5,782,035	3,254,230	42,011,528			
Total Annual Volume, gallons	569,748,670	915,773,422	105,923,993	690,218,456	1,323,811,418	666,419,882	1,405,047,188
Annual Precipitation, inches	42.8	31.1	24.9	31.5	40.3	32.2	42.6

Appendix F — Technical Calculations

Several of the Excel® spreadsheet tools used to evaluate a discharger's ability to meet Washington State water quality standards can be found on Ecology's homepage at <http://www.ecy.wa.gov/programs/eap/pwspread/pwspread.html>.

Simple Mixing:

Ecology uses simple mixing calculations to assess the impacts of certain conservative pollutants, such as the expected increase in fecal coliform bacteria at the edge of the chronic mixing zone boundary. Simple mixing uses a mass balance approach to proportionally distribute a pollutant load from a discharge into the authorized mixing zone. The approach assumes no decay or generation of the pollutant of concern within the mixing zone. The predicted concentration at the edge of a mixing zone (MC) is based on the following calculation:

$$MC = [EC + (AC \times DF)] / (1 + DF)$$

where:

EC	=	Effluent Concentration
AC	=	Ambient Concentration
DF	=	Dilution Factor

Reasonable Potential Analysis:

The process and formulas for determining reasonable potential and effluent limits are taken directly from the *Technical Support Document for Water Quality-based Toxics Control*, (EPA 505/2-90-001). The adjustment for autocorrelation is from EPA (1996a), and EPA (1996b).

Calculation of Water Quality-Based Effluent Limits:

Water quality-based effluent limits are calculated by the two-value wasteload allocation process as described on page 100 of the TSD (EPA, 1991) and shown below.

1. Calculate the acute wasteload allocation WLA_a by multiplying the acute criteria by the acute dilution factor and subtracting the background factor. Calculate the chronic wasteload allocation (WLA_c) by multiplying the chronic criteria by the chronic dilution factor and subtracting the background factor.

$$WLA_a = (\text{acute criteria} \times DF_a) - [(\text{background conc.} \times (DF_a - 1))]$$

$$WLA_c = (\text{chronic criteria} \times DF_c) - [(\text{background conc.} \times (DF_c - 1))]$$

where: DF_a = Acute Dilution Factor

DF_c = Chronic Dilution Factor

2. Calculate the long term averages (LTA_a and LTA_c) which will comply with the wasteload allocations WLA_a and WLA_c .

$$LTA_a = WLA_a \times e^{[0.5\sigma^2 - z\sigma]}$$

where: $\sigma^2 = \ln[CV^2 + 1]$

$z = 2.326$

$CV = \text{coefficient of variation} = \text{std. dev.}/\text{mean}$

$$LTA_c = WLA_c \times e^{[0.5\sigma^2 - z\sigma]}$$

where: $\sigma^2 = \ln[(CV^2 \div 4) + 1]$

$z = 2.326$

3. Use the smallest LTA of the LTA_a or LTA_c to calculate the maximum daily effluent limit and the monthly average effluent limit.

Maximum Daily Limit = MDL

$$MDL = LTA \times e^{[z\sigma - 0.5\sigma^2]}$$

where: $\sigma^2 = \ln[CV^2 + 1]$
 $z = 2.326$ (99th percentile occurrence)
 LTA = Limiting long term average

Average Monthly Limit = AML

$$AML = LTA \times e^{[z\sigma_n - 0.5\sigma_n^2]}$$

where: $\sigma_n^2 = \ln[(CV^2 \div n) + 1]$
 $n = \text{number of samples/month}$
 $z = 1.645$ (95th percentile occurrence)
 LTA = Limiting long term average

West Point WWTP - Calculations

Calculation of BOD₅ Oxidation with Temperature Adjustment

INPUT - West Point WWTP	Notes
Effluent BOD ₅ (mg/L)	45 Tech-based permitted max weekly value
Effluent Dissolved Oxygen (DO) (mg/L)	2.0 Conservative estimate, small impact on results
Receiving Water Temperature (deg C)	14 1 DADMax value from KC's ambient study
Receiving Water DO (mg/L)	6.10 10% value from KC's ambient study
DO WQ Standards (mg/L)	7
Chronic Mixing Dilution Factor	188
Time for effluent to travel from outfall to chronic mixing boundary (days)	0.758 Small impact, so approximate-->Mixing document shows min current = 0.2 cm/s, therefore to reach chronic boundary at 430' (131 m) would take approx 0.758 days.
Oxidation rate of BOD, base e at 20 deg C, k_1 (day ⁻¹)*	0.23 * $k_1 = 0.12-0.23 \text{ day}^{-1}$ for effluent from biological treatment process (<i>Metcalf and Eddy Wastewater Engineering Treatment and Reuse. Fourth edition, page 86. 2003.</i>)
OUTPUT	
Effluent Ultimate BOD (mg/L)	65.85
Oxidation rate of BOD at ambient temperature, base e (day ⁻¹)	0.17
BOD oxidized between outfall and chronic mixing zone (mg/L)	8.16
RESULTS	
DO at chronic mixing zone	6.03
Difference between ambient DO and DO at chronic mixing boundary	0.07
There is no reasonable potential of not meeting the DO criteria under these conditions.	

Calculation of pH of a Mixture in Marine Water

Based on the CO2SYS program (Lewis and Wallace, 1998),
<http://cdiac.esd.ornl.gov/oceans/co2rprt.html>

INPUT - West Point WWTP	
1. MIXING ZONE BOUNDARY CHARACTERISTICS	
Dilution factor at mixing zone boundary	188
Depth at plume trapping level (m)	1.000
2. BACKGROUND RECEIVING WATER CHARACTERISTICS	
Temperature (deg C):	14.00
pH:	8.00
Salinity (psu):	26.10
Total alkalinity (meq/L)	1.90
3. EFFLUENT CHARACTERISTICS	
Temperature (deg C):	21.00
pH:	7.80
Salinity (psu)	12.00
Total alkalinity (meq/L):	0.55
4. CLICK THE 'Calculate" BUTTON TO UPDATE OUTPUT RESULTS -->	Calculate
OUTPUT	
CONDITIONS AT THE MIXING ZONE BOUNDARY	
Temperature (deg C):	14.04
Salinity (psu)	26.03
Density (kg/m ³)	1019
Alkalinity (mmol/kg-SW):	122.13
Total Inorganic Carbon (mmol/kg-SW):	117
pH at Mixing Zone Boundary:	8.00

Calculation of Fecal Coliform at Chronic Mixing Zone

INPUT - West Point WWTP		
Chronic Dilution Factor	188	
Receiving Water Fecal Coliform, #/100 ml	4	Maximum value from KC's ambient study
Effluent Fecal Coliform - worst case, #/100 ml	400	Maximum permitted limit
Surface Water Criteria, #/100 ml	14	
OUTPUT		
Fecal Coliform at Mixing Zone Boundary, #/100 ml	6	<14
Difference between mixed and ambient, #/100 ml	2	

Marine Un-ionized Ammonia Criteria Calculation

Calculation of seawater fraction of un-ionized ammonia from Hampson (1977). Un-ionized ammonia criteria for salt water are from EPA 440/5-88-004. Revised 19-Oct-93.

INPUT	
1. Receiving Water Temperature, deg C (1 DADmax):	14.0
2. Receiving Water pH, (max):	8.0
3. Receiving Water Salinity, g/kg (min):	26.1
4. Pressure, atm (EPA criteria assumes 1 atm):	1.0
5. Unionized ammonia criteria (mg un-ionized NH ₃ per liter) from EPA 440/5-88-004:	
Acute:	0.233
Chronic:	0.035
OUTPUT	
Using mixed temp and pH at mixing zone boundaries?	No
1. Molal Ionic Strength (not valid if >0.85):	0.534
2. pKa8 at 25 deg C (Whitfield model "B"):	9.307
3. Percent of Total Ammonia Present as Unionized:	2.1%
4. Total Ammonia Criteria (mg/L as <u>NH₃</u>):	
Acute:	10.85
Chronic:	1.63
RESULTS	
Total Ammonia Criteria (mg/L as <u>N</u>)	
Acute:	8.92
Chronic:	1.34

Reasonable Potential Calculation

Facility	West Point WWTP
Water Body Type	Marine

Dilution Factors:	Acute	Chronic
Aquatic Life	28	188
Human Health Carcinogenic		324
Human Health Non-Carcinogenic		324

Pollutant, CAS No. & NPDES Application Ref. No.		AMMONIA, Criteria as Total NH3	1,4-DICHLOROBENZENE 106467 22B	2,4-DICHLOROPHENOL 120832 2A	2,4-DIMETHYLPHENOL 105679	ANTIMONY (INORGANIC) 7440360 1M	ARSENIC (dissolved) 7440382 2M	BIS(2-ETHYLHEXYL) PHTHALATE 117817 13B	CADMIUM - 7440439 4M	CHLOROFORM 67663 11V	CHROMIUM(HEX) 18540299**	COPPER - 744058 6M
		53	9	9	9	15	15	9	15	9	15	15
Effluent Data	# of Samples (n)	53	9	9	9	15	15	9	15	9	15	15
	Coeff of Variation (Cv)	0.26	0.6	0.6	0.6	0.3	0.6	0.6	0.6	0.6	0.6	0.6
	Effluent Concentration, ug/L (Max. or 95th Percentile)	31,000	10.2	0.96	0.48		2.196	7.332	0.1233	5.68	1.235	16.3
	Calculated 50th percentile Effluent Conc. (when n>10)					0.44						
Receiving Water Data	90th Percentile Conc., ug/L	85					1.388		0.072		0.139	0.487
	Geo Mean, ug/L		0	0	0	0		0		0		
Water Quality Criteria	Aquatic Life Criteria, Acute ug/L	8,923	-	-	-	-	69	-	42	-	1100	4.8
	Chronic ug/L	1,340	-	-	-	-	36	-	9.3	-	50	3.1
	WQ Criteria for Protection of Human Health, ug/L	-	2600	790	850	4300	-	5.9	-	470	-	-
	Metal Criteria Acute	-	-	-	-	-	1.000	-	0.980*	-	0.960*	0.790*
	Translator, decimal Chronic	-	-	-	-	-	-	-	0.980*	-	0.960*	0.790*
	Carcinogen?	N	N	N	N	N	Y	Y	N	Y	N	N

Aquatic Life Reasonable Potential

Effluent percentile value		0.950					0.950		0.950		0.950	0.950
s	$s^2 = \ln(CV^2 + 1)$	0.256					0.555		0.555		0.555	0.555
Pn	$Pn = (1 - \text{confidence level})^{1/n}$	0.945					0.819		0.819		0.819	0.819
Multiplier		1.00					1.50		1.50		1.50	1.50
Max concentration (ug/L) at edge of...	Acute	1,189					1.456		0.076		0.198	1.160
	Chronic	249					1.398		0.073		0.148	0.587
Reasonable Potential?		NO					NO		NO		NO	NO

Human Health Reasonable Potential

s	$s^2 = \ln(CV^2 + 1)$	0.5545	0.5545	0.5545	0.2747		0.5545		0.5545		
Pn	$Pn = (1 - \text{confidence level})^{1/n}$	0.717	0.717	0.717	0.819		0.717		0.717		
Multiplier		0.7276	0.7276	0.7276	0.7785		0.7276		0.7276		
Dilution Factor		324	324	324	324		324		324		
Max Conc. at edge of Chronic Zone, ug/L		0.0229	0.0022	0.0011	0.0014		1.6E-02		0.0128		
Reasonable Potential?		NO	NO	NO	NO		NO		NO		

Comments/Notes: *Translator derived from receiving water data. **Data only available for total chromium - conservative evaluation.

References: WAC 173-201A,

Technical Support Document for Water Quality-based Toxics Control, US EPA, March 1991, EPA/505/2-90-001, pages 56/99

Reasonable Potential Calculation - Page 2

Facility	West Point WWTP
Water Body Type	Marine

Dilution Factors:		Acute	Chronic
Aquatic Life		28	188
Human Health Carcinogenic			324
Human Health Non-Carcinogenic			324

Pollutant, CAS No. & NPDES Application Ref. No.		CYANIDE 57125 14M	DIETHYLPHTHALATE 84662 24B	LEAD - 7439921 7M	MANGANESE 7439965	METHYLENE CHLORIDE 75092 22V	MERCURY 7439976 8M	NICKEL - 7440020 9M	PHENOL 108952 10A	PYRENE 129000 45B	SELENIUM 7782492 10M	SILVER - 7740224 11M
				15	9	15	8	9	21	23	9	9
Effluent Data	# of Samples (n)	15	9	15	8	9	21	23	9	9	15	15
	Coeff of Variation (Cv)	0.0001	0.6	0.6	0.6	0.6	0.63	0.48	0.6	0.6	0.373	0.6
	Effluent Concentration, ug/L (Max. or 95th Percentile)	0.57	0.85	2.475	71.1	5.3	0.0155	5.999	0.95	0.29	0.74	0.143
	Calculated 50th percentile Effluent Conc. (when n>10)	0.005					0.005	2.81		0.5		
Receiving Water Data	90th Percentile Conc., ug/L	0		0.005			0.0002	0.432			0	0.028
	Geo Mean, ug/L	0	0		0	0	0.0002	0.410	0	0	0	
Water Quality Criteria	Aquatic Life Criteria, Acute ug/L	9.1	-	210	-	-	1.8	74	-	-	290	1.9
	Chronic	2.8	-	8.1	-	-	0.025	8.2	-	-	71	-
	WQ Criteria for Protection of Human Health, ug/L	220000	120000	-	100	1600	0.15	4600	5E+06	11000	4200	-
	Metal Criteria, Acute	-	-	0.951	-	-	0.85	1.000*	-	-	-	0.85
	Translator, decimal	-	-	0.951	-	-	-	1.000*	-	-	-	-
	Carcinogen?	N	N	N	N	Y	N	N	N	N	N	N

Aquatic Life Reasonable Potential

Effluent percentile value		0.950	0.950	0.950	0.950	0.950	0.950	0.950	0.950	0.950	0.950	0.950
s	$s^2 = \ln(CV^2 + 1)$	0.000	0.555	0.555	0.555	0.578	0.455	0.578	0.455	0.578	0.455	0.578
Pn	$Pn = (1 - \text{confidence level})^{1/n}$	0.819	0.819	0.819	0.819	0.867	0.878	0.867	0.878	0.867	0.878	0.867
Multiplier		1.00	1.50	1.50	1.50	1.00	1.00	1.00	1.00	1.00	1.30	1.50
Max concentration (ug/L) at edge of...	Acute	0.020	0.131	0.131	0.131	0.001	0.631	0.001	0.631	0.001	0.034	0.034
	Chronic	0.003	0.024	0.024	0.024	0.000	0.462	0.000	0.462	0.000	0.005	0.029
Reasonable Potential?		NO	NO	NO	NO	NO	NO	NO	NO	NO	NO	NO

Human Health Reasonable Potential

s	$s^2 = \ln(CV^2 + 1)$	1E-04	0.5545	0.5545	0.5545	0.5781	0.4553	0.5545	0.5545	0.5545	0.3609
Pn	$Pn = (1 - \text{confidence level})^{1/n}$	0.819	0.717	0.688	0.717	0.867	0.878	0.717	0.717	0.717	0.819
Multiplier		0.9999	0.7276	0.7624	0.7276	0.5256	0.5885	0.7276	0.7276	0.7276	0.7197
Dilution Factor		324	324	324	324	324	324	324	324	324	324
Max Conc. at edge of Chronic Zone, ug/L		2E-05	0.0019	0.167	0.012	2.1E-04	0.42	0.0021	0.0007	0.0015	0.0015
Reasonable Potential?		NO	NO	NO	NO	NO	NO	NO	NO	NO	NO

Comments/Notes: *Translator derived from receiving water data.

References: [WAC 173-201A](#),

Technical Support Document for Water Quality-based Toxics Control, US EPA, March 1991, EPA/505/2-90-001, pages 56/99

Reasonable Potential Calculation - Page 3

Facility	West Point WWTP
Water Body Type	Marine

Dilution Factors:	Acute	Chronic
Aquatic Life	28	188
Human Health Carcinogenic		324
Human Health Non-Carcinogenic		324

Pollutant, CAS No. & NPDES Application Ref. No.	THALLIUM 7440280 12M	TOLUENE 108883 25V	ZINC- 7440666 13M	CHLORINE (Total Residual) 7782505	
		15	9	23	1825
Effluent Data	# of Samples (n)	15	9	23	1825
	Coeff of Variation (Cv)	0.478	0.6	0.226	0.32
	Effluent Concentration, ug/L (Max. or 95th Percentile)		1.1	50.78	296
	Calculated 50th percentile Effluent Conc. (when n>10)	0.040			
Receiving Water Data	90th Percentile Conc., ug/L		0.995	0	
	Geo Mean, ug/L	0	0		
Water Quality Criteria	Aquatic Life Criteria, Acute ug/L	-	-	90	13
	Chronic	-	-	81	7.5
	WQ Criteria for Protection of Human Health, ug/L	6.3	200000	-	-
	Metal Criteria Acute	-	-	0.946	-
	Translator, decimal Chronic	-	-	0.946	-
	Carcinogen?	N	N	N	N

Aquatic Life Reasonable Potential

Effluent percentile value		0.950	0.950
s	$s^2 = \ln(CV^2 + 1)$	0.223	0.312
Pn	$Pn = (1 - \text{confidence level})^{1/n}$	0.878	0.998
Multiplier		1.00	1.00
Max concentration (ug/L) at edge of...	Acute	2.7	10.6
	Chronic	1.2	1.6
Reasonable Potential?		NO	NO

Human Health Reasonable Potential

s	$s^2 = \ln(CV^2 + 1)$	0.4536	0.5545
Pn	$Pn = (1 - \text{confidence level})^{1/n}$	0.819	0.717
Multiplier		0.6614	0.7276
Dilution Factor		324	324
Max Conc. at edge of Chronic Zone, ug/L		0.0001	0.0025
Reasonable Potential?		NO	NO

Comments/Notes:

References: WAC 173-201A,

Technical Support Document for Water Quality-based Toxics Control, US EPA, March 1991, EPA/505/2-90-001, pages 56/99

Chlorine Limit Calculation

Facility	West Point WWTP
Water Body Type	Marine

Dilution Factors:	Acute	Chronic
Aquatic Life	28	188
Human Health Carcinogenic		324
Human Health Non-Carcinogenic		324

Pollutant, CAS No. & NPDES Application Ref. No.		CHLORINE (Total Residual) 7782505						
Effluent Data	Coeff of Variation (Cv)	0.6						
Receiving Water Data	90th Percentile Conc., ug/L	0						
	Geo Mean, ug/L							
Water Quality Criteria	Aquatic Life Criteria, Acute ug/L	13						
	Chronic ug/L	7.5						
	WQ Criteria for Protection of Human Health, ug/L	-						
	Metal Criteria Acute Translator, decimal	-						
	Chronic Carcinogen?	- N						

Aquatic Life Limit Calculation

# of Compliance Samples Expected per month		30
LTA Coeff. Var. (CV), decimal		0.6
Permit Limit Coeff. Var. (CV), decimal		0.6
Waste Load Allocations, ug/L	Acute	364
	Chronic	1410
Long Term Averages, ug/L	Acute	117
	Chronic	744
Limiting LTA, ug/L		117
Metal Translator or 1?		1.00
Average Monthly Limit (AML), ug/L		139
Maximum Daily Limit (MDL), ug/L		364

Comments/Notes:

References: WAC 173-201A,

Technical Support Document for Water Quality-based Toxics Control, US EPA, March 1991, EPA/505/2-90-001, pag

Marine Temperature Reasonable Potential and Limit Calculation

Based on WAC 173-201A-200(1)(c)(i)--(ii) and Water Quality Program Guidance. All Data inputs must meet WQ guidelines. The Water Quality temperature guidance document may be found at:

<http://www.ecy.wa.gov/biblio/0610100.html>

INPUT - West Pt WWTP	
1. Chronic Dilution Factor at Mixing Zone Boundary	188
2. Annual max 1DADMax Ambient Temperature	14.0 °C
3. 1DADMax Effluent Temperature (95th percentile)	21.0 °C
4. Aquatic Life Temperature WQ Criterion	13.0 °C
OUTPUT	
5. Temperature at Chronic Mixing Zone Boundary:	14.04 °C
6. Incremental Temperature Increase or decrease:	0.04 °C
7. Incremental Temperature Increase $12/(T-2)$ if $T \leq$ crit:	---
8. Maximum Allowable Temperature at Mixing Zone Boundary:	14.3 °C
A. If ambient temp is warmer than WQ criterion	
9. Does temp fall within this warmer temp range?	YES
10. Temp increase allowed at mixing zone boundary, if required:	NO LIMIT
B. If ambient temp is cooler than WQ criterion but within $12/(T_{amb}-2)$ and within 0.3 °C of the criterion	
11. Does temp fall within this incremental temp. range?	---
12. Temp increase allowed at mixing zone boundary, if required:	---
C. If ambient temp is cooler than (WQ criterion-0.3) but within $12/(T_{amb}-2)$ of the criterion	
13. Does temp fall within this Incremental temp. range?	---
14. Temp increase allowed at mixing zone boundary, if required:	---
D. If ambient temp is cooler than (WQ criterion - $12/(T_{amb}-2)$)	
15. Does temp fall within this Incremental temp. range?	---
16. Temp increase allowed at mixing zone boundary, if required:	---
RESULTS	
17. Do any of the above cells show a temp increase?	NO
18. Temperature Limit if Required?	NO LIMIT

Alki CSO Treatment Plant - Calculations

DO Drop at Chronic Mixing Zone

INPUT - Alki CSO TP		Notes
Effluent BOD ₅ (mg/L)	51	Max month - DMR data
Effluent Dissolved Oxygen (DO) (mg/L)	5	Conservative estimate - small impact on results
Receiving Water Temperature (deg C)	12.7	KC's 2013 Receiving Water Rpt -1 DADMax
Receiving Water DO (mg/L)	5.8	KC's 2013 Receiving Water Rpt -10th percentile
DO WQ Standards (mg/L)	7	
Chronic Mixing Dilution Factor	99	
Time for effluent to travel from outfall to chronic mixing boundary (days)	0.008	(refer to mixing model if available)
Oxidation rate of BOD, base e at 20 deg C, k_1 (day ⁻¹)*	0.23	* $k_1 = 0.12-0.23 \text{ day}^{-1}$ for effluent from biological treatment process (<i>Metcalf and Eddy Wastewater Engineering Treatment and Reuse. Fourth edition, page 86. 2003.</i>)
OUTPUT		
Effluent Ultimate BOD (mg/L)	75	
Oxidation rate of BOD at ambient temperature, base e (day ⁻¹)	0.16	
BOD oxidized between outfall and chronic mixing zone (mg/L)	0.10	
RESULTS		
DO at chronic mixing zone	5.79	
Difference between ambient DO and DO at chronic mixing boundary	0.01	
There is no reasonable potential of not meeting the DO criteria under these conditions.		

Calculation of pH of a Mixture in Marine Water

Based on the CO2SYS program (Lewis and Wallace, 1998),
<http://cdiac.esd.ornl.gov/oceans/co2rprt.html>

INPUT - Aiki CSO TP	
1. MIXING ZONE BOUNDARY CHARACTERISTICS	
Dilution factor at mixing zone boundary	99
Depth at plume trapping level (m)	1.000
2. BACKGROUND RECEIVING WATER CHARACTERISTICS	
Temperature (deg C):	12.70
pH:	7.40
Salinity (psu):	27.70
Total alkalinity (meq/L)	1.98
3. EFFLUENT CHARACTERISTICS	
Temperature (deg C):	0.00
pH:	5.80
Salinity (psu)	12.00
Total alkalinity (meq/L):	0.80
4. CLICK THE 'Calculate" BUTTON TO UPDATE OUTPUT RESULTS -->	Calculate
OUTPUT	
CONDITIONS AT THE MIXING ZONE BOUNDARY	
Temperature (deg C):	12.57
Salinity (psu)	27.54
Density (kg/m ³)	1021
Alkalinity (mmol/kg-SW):	1.93
Total Inorganic Carbon (mmol/kg-SW):	2
pH at Mixing Zone Boundary:	7.32

Calculation of Fecal Coliform at Chronic Mixing Zone

INPUT - Aiki CSO TP		
Chronic Dilution Factor	99	
Receiving Water Fecal Coliform, #/100 ml	1	KC's 2013 Receiving Water Rpt
Effluent Fecal Coliform - worst case, #/100 ml	400	
Surface Water Criteria, #/100 ml	14	
OUTPUT		
Fecal Coliform at Mixing Zone Boundary, #/100 ml	5	No Reasonable potential
Difference between mixed and ambient, #/100 ml	4	

Conclusion: At design flow, the discharge has no reasonable potential to violate water quality standards for fecal coliform.

Marine Un-ionized Ammonia Criteria Calculation

Calculation of seawater fraction of un-ionized ammonia from Hampson (1977). Un-ionized ammonia criteria for salt water are from EPA 440/5-88-004. Revised 19-Oct-

INPUT - Aiki CSO TP	
1. Receiving Water Temperature, deg C (max 1DADmax):	12.7
2. Receiving Water pH, (max):	8.0
3. Receiving Water Salinity, g/kg (min):	27.7
4. Pressure, atm (EPA criteria assumes 1 atm):	1.0
5. Unionized ammonia criteria (mg un-ionized NH ₃ per liter) from EPA 440/5-88-004:	
Acute:	0.233
Chronic:	0.035
OUTPUT	
Using mixed temp and pH at mixing zone boundaries?	No
1. Molal Ionic Strength (not valid if >0.85):	0.568
2. pKa8 at 25 deg C (Whitfield model "B"):	9.311
3. Percent of Total Ammonia Present as Unionized:	1.9%
4. Total Ammonia Criteria (mg/L as <u>NH₃</u>):	
Acute:	12.04
Chronic:	1.81
RESULTS	
Total Ammonia Criteria (mg/L as <u>N</u>)	
Acute:	9.90
Chronic:	1.49

Reasonable Potential Calculation

Facility	Alki CSO TP
Water Body Type	Marine

Dilution Factors:	Acute	Chronic
Aquatic Life	20.0	99
Human Health Carcinogenic		99
Human Health Non-Carcinogenic		99

Pollutant, CAS No. & NPDES Application Ref. No.		AMMONIA, Criteria as Total NH3	ANTIMONY (INORGANIC) 7440360 1M	ARSENIC (dissolved) 7440382 2M	BIS(2-ETHYLHEXYL) PHTHALATE 117817 13B	BUTYLBENZYL PHTHALATE 85687 15B	CADMIUM - 7440439 4M	CHLORINE (Total Residual) 7782505	CHLOROFORM 67663 11V	CHROMIUM(HEX) 18540299**	COPPER - 744058 6M	DIETHYLPHTHALATE 84662 24B
		1	7	7	7	7	7	16	7	7	7	7
Effluent Data	# of Samples (n)	1	7	7	7	7	7	16	7	7	7	7
	Coeff of Variation (Cv)	0.6	0.6	0.6	0.6	0.6	0.6	0.6	0.6	0.6	0.6	0.6
	Effluent Concentration, ug/L (Max. or 95th Percentile)	2,180	0.7	2.28	3.65	0.43	0.13	1708	14	2.2	12.3	3.69
	Calculated 50th percentile Effluent Conc. (when n>10)											
Receiving Water Data	90th Percentile Conc., ug/L	85		1.45			0.073	0		0.15	0.354	
	Geo Mean, ug/L		0.172		0	0			0			0
Water Quality Criteria	Aquatic Life Criteria, Acute ug/L	38,840	-	69	-	-	42	13	-	1100	4.8	-
	Chronic ug/L	5,834	-	36	-	-	9.3	7.5	-	50	3.1	-
	WQ Criteria for Protection of Human Health, ug/L	-	4300	-	5.9	1900	-	-	470	-	-	120000
	Metal Criteria Acute Translator, decimal	-	-	0.980*	-	-	0.095*	-	-	0.993	0.920*	-
	Chronic	-	-	1.000	-	-	0.095*	-	-	0.993	0.920*	-
	Carcinogen?	N	N	Y	Y	N	N	N	Y	N	N	N

Aquatic Life Reasonable Potential

Effluent percentile value		0.950	0.950	0.950	0.950	0.950	0.950
s	$s^2 = \ln(CV^2 + 1)$	0.555	0.555	0.555	0.555	0.555	0.555
Pn	$Pn = (1 - \text{confidence level})^{1/n}$	0.050	0.652	0.652	0.829	0.652	0.652
Multiplier		6.20	2.01	2.01	1.47	2.01	2.01
Max concentration (ug/L) at edge of...	Acute	756	1.602	0.071	125.459	0.362	1.471
	Chronic	221	1.482	0.073	25.345	0.193	0.580
Reasonable Potential?		NO	NO	NO	YES	NO	NO

Human Health Reasonable Potential

s	$s^2 = \ln(CV^2 + 1)$	0.5545	0.5545	0.5545	0.5545	0.5545
Pn	$Pn = (1 - \text{confidence level})^{1/n}$	0.652	0.652	0.652	0.652	0.652
Multiplier		0.8054	0.8054	0.8054	0.8054	0.8054
Dilution Factor		99	99	99	99	99
Max Conc. at edge of Chronic Zone, ug/L		0.176	0.0297	0.0035	0.1139	0.03
Reasonable Potential?		NO	NO	NO	NO	NO

Comments/Notes: *Translator derived from receiving water data. **Data only available for total chromium - conservative evaluation.

References: WAC 173-201A, Technical Support Document for Water Quality-based Toxics Control, US EPA, March 1991, EPA/505/2-90-001, pages 56/99

Reasonable Potential Calculation - Page 2

Facility	Alki CSO TP
Water Body Type	Marine

Dilution Factors:	Acute	Chronic
Aquatic Life	20.0	99
Human Health Carcinogenic		99
Human Health Non-Carcinogenic		99

Pollutant, CAS No. & NPDES Application Ref. No.		LEAD - 7439921 7M	MERCURY 7439976 8M	NICKEL - 7440020 9M	SILVER - 7740224 11M	ZINC- 7440666 13M	CYANIDE 57125 14M					
Effluent Data	# of Samples (n)	7	7	7	7	7	6					
	Coeff of Variation (Cv)	0.6	0.6	0.6	0.6	0.6	0.6					
	Effluent Concentration, ug/L (Max. or 95th Percentile)	4.7	0.025	3.37	0.1	42.9	18.3					
	Calculated 50th percentile Effluent Conc. (when n>10)											
Receiving Water Data	90th Percentile Conc., ug/L	0.006	0.0002	0.427	0.026	0.605	0					
	Geo Mean, ug/L		0.0002	0.411			0					
Water Quality Criteria	Aquatic Life Criteria, Acute ug/L	210	1.8	74	1.9	90	9.1					
	Chronic ug/L	8.1	0.025	8.2	-	81	2.8					
	WQ Criteria for Protection of Human Health, ug/L	-	0.15	4600	-	-	220000					
	Metal Criteria Acute Translator, decimal	0.951	0.850	0.950*	0.850*	0.946*	-					
	Chronic	0.951	-	0.950*	-	0.946*	-					
	Carcinogen?	N	N	N	N	N	N					

Aquatic Life Reasonable Potential

Effluent percentile value		0.950	0.950	0.950	0.950	0.950	0.950
s	$s^2=\ln(CV^2+1)$	0.555	0.555	0.555	0.555	0.555	0.555
Pn	$Pn=(1-\text{confidence level})^{1/n}$	0.652	0.652	0.652	0.652	0.652	0.607
Multiplier		2.01	2.01	2.01	2.01	2.01	2.14
Max concentration (ug/L) at edge of...	Acute	0.454	0.002	0.727	0.033	4.643	1.960
	Chronic	0.096	0.001	0.488	0.028	1.421	0.396
Reasonable Potential? Limit Required?		NO	NO	NO	NO	NO	NO

Human Health Reasonable Potential

s	$s^2=\ln(CV^2+1)$	0.5545	0.5545		0.5545
Pn	$Pn=(1-\text{confidence level})^{1/n}$	0.652	0.652		0.607
Multiplier		0.8054	0.8054		0.8603
Dilution Factor		99	99		99
Max Conc. at edge of Chronic Zone, ug/L		0.0004	0.4343		1.6E-01
Reasonable Potential? Limit Required?		NO	NO		NO

Comments/Notes: *Translator derived from receiving water data.

References: WAC 173-201A,

Technical Support Document for Water Quality-based Toxics Control, US EPA, March 1991, EPA/505/2-90-001, pages 56/99

Aquatic Life and Human Health Limits Calculations

Facility	Alki CSO TP
Water Body Type	Marine

Dilution Factors:	Acute	Chronic
Aquatic Life	20	99
Human Health Carcinogenic		99
Human Health Non-Carcinogenic		99

Pollutant, CAS No. & NPDES Application Ref. No.		CHLORINE (Total Residual) 7782505	Chlorine Limit from 2009 permit								
Acute Dilution Factor		20	18								
Chronic Dilution Factor		99	61								
Effluent Data	Coeff of Variation (Cv)	0.6	0.6	0.6	0.6	0.6	0.6	0.6	0.6	0.6	0.6
Receiving Water Data	90th Percentile Conc., ug/L	0	0	0	0	0					
	Geo Mean, ug/L	0	0	0	0	0					
Water Quality Criteria	Aquatic Life Criteria, Acute ug/L	13	13								
	Chronic	7.5	7.5								
	WQ Criteria for Protection of Human Health, ug/L	-	-								
	Metal Criteria, Acute	-	-								
	Translator, decimal Chronic	-	-								
	Carcinogen?	N	N								

Aquatic Life Limit Calculation

# of Compliance Samples Expected per month		4	4
LTA Coeff. Var. (CV), decimal		0.6	0.6
Permit Limit Coeff. Var. (CV), decimal		0.6	0.6
Waste Load Allocations, ug/L	Acute	260	234
	Chronic	743	458
Long Term Averages, ug/L	Acute	83	75
	Chronic	392	241
Limiting LTA, ug/L		83	75
Metal Translator or 1?		1.00	1.00
Average Monthly Limit (AML), ug/L		130	117
Maximum Daily Limit (MDL), ug/L		260	234

Comments/Notes:

References: WAC 173-201A, Technical Support Document for Water Quality-based Toxics Control, US EPA, March 1991, EPA/505/2-90-001, pages 56/99

Marine Temperature Reasonable Potential and Limit Calculation

Based on WAC 173-201A-200(1)(c)(i)--(ii) and Water Quality Program Guidance. All Data inputs must meet WQ guidelines. The Water Quality temperature guidance document may be found at:

<http://www.ecy.wa.gov/biblio/0610100.html>

INPUT - Aiki CSO TP	
1. Chronic Dilution Factor at Mixing Zone Boundary	99
2. Annual max 1DADMax Ambient Temperature (Background 90th percentile)	12.7 °C
3. 1DADMax Effluent Temperature (95th percentile)	21.0 °C
4. Aquatic Life Temperature WQ Criterion	13.0 °C
OUTPUT	
5. Temperature at Chronic Mixing Zone Boundary:	12.78 °C
6. Incremental Temperature Increase or decrease:	0.08 °C
7. Incremental Temperature Increase $12/(T-2)$ if $T \leq$ crit:	1.12 °C
8. Maximum Allowable Temperature at Mixing Zone Boundary:	13.00 °C
A. If ambient temp is warmer than WQ criterion	
9. Does temp fall within this warmer temp range?	NO
10. Temp increase allowed at mixing zone boundary, if required:	---
B. If ambient temp is cooler than WQ criterion but within $12/(T_{amb}-2)$ and within 0.3 °C of the criterion	
11. Does temp fall within this incremental temp. range?	NO
12. Temp increase allowed at mixing zone boundary, if required:	---
C. If ambient temp is cooler than (WQ criterion-0.3) but within $12/(T_{amb}-2)$ of the criterion	
13. Does temp fall within this Incremental temp. range?	YES
14. Temp increase allowed at mixing zone boundary, if required:	NO LIMIT
D. If ambient temp is cooler than (WQ criterion - $12/(T_{amb}-2)$)	
15. Does temp fall within this Incremental temp. range?	NO
16. Temp increase allowed at mixing zone boundary, if required:	---
RESULTS	
17. Do any of the above cells show a temp increase?	NO
18. Temperature Limit if Required?	NO LIMIT

Carkeek CSO Treatment Plant - Calculations

DO Drop at Chronic Mixing Zone

INPUT - Carkeek CSO TP		Notes
Effluent BOD ₅ (mg/L)	132	Max month - DMR data
Effluent Dissolved Oxygen (DO) (mg/L)	5	Conservative estimate - small impact on results
Receiving Water Temperature (deg C)	14	KC's 2013 Receiving Water Rpt -1 DADMax
Receiving Water DO (mg/L)	6.1	KC's 2013 Receiving Water Rpt -10th percentile
DO WQ Standards, Marine Extraordinary (mg/L)	7	
Chronic Mixing Dilution Factor	104	
Time for effluent to travel from outfall to chronic mixing boundary (days)	0.008	(refer to mixing model if available)
Oxidation rate of BOD, base e at 20 deg C, k_1 (day ⁻¹)*	0.23	* $k_1 = 0.12-0.23 \text{ day}^{-1}$ for effluent from biological treatment process (<i>Metcalf and Eddy Wastewater Engineering Treatment and Reuse. Fourth edition, page 86. 2003.</i>)
OUTPUT		
Effluent Ultimate BOD (mg/L)	193	
Oxidation rate of BOD at ambient temperature, base e (day ⁻¹)	0.17	
BOD oxidized between outfall and chronic mixing zone (mg/L)	0.28	
RESULTS		
DO at chronic mixing zone	6.09	
Difference between ambient DO and DO at chronic mixing boundary	0.01	
There is no reasonable potential of not meeting the DO criteria under these conditions.		

Calculation of pH of a Mixture in Marine Water

Based on the CO2SYS program (Lewis and Wallace, 1998),
<http://cdiac.esd.ornl.gov/oceans/co2rprt.html>

INPUT - Carkeek CSO TP	
1. MIXING ZONE BOUNDARY CHARACTERISTICS	
Dilution factor at mixing zone boundary	104
Depth at plume trapping level (m)	1.000
2. BACKGROUND RECEIVING WATER CHARACTERISTICS	
Temperature (deg C):	14.00
pH:	7.50
Salinity (psu):	26.10
Total alkalinity (meq/L)	1.90
3. EFFLUENT CHARACTERISTICS	
Temperature (deg C):	0.00
pH:	5.10
Salinity (psu)	12.00
Total alkalinity (meq/L):	0.55
4. CLICK THE 'Calculate" BUTTON TO UPDATE OUTPUT RESULTS -->	Calculate
OUTPUT	
CONDITIONS AT THE MIXING ZONE BOUNDARY	
Temperature (deg C):	13.87
Salinity (psu)	25.96
Density (kg/m ³)	1019
Alkalinity (mmol/kg-SW):	1.85
Total Inorganic Carbon (mmol/kg-SW):	2
pH at Mixing Zone Boundary:	7.22

Calculation of Fecal Coliform at Chronic Mixing Zone

INPUT - Carkeek CSO TP		
Chronic Dilution Factor	104	
Receiving Water Fecal Coliform, #/100 ml	4	KC 2013 receiving water study
Effluent Fecal Coliform - worst case, #/100 ml	400	Guidance-based limit
Surface Water Criteria, #/100 ml	14	
OUTPUT		
Fecal Coliform at Mixing Zone Boundary, #/100 ml	8	< 14
Difference between mixed and ambient, #/100 ml	4	

Marine Un-ionized Ammonia Criteria Calculation

Calculation of seawater fraction of un-ionized ammonia from Hampson (1977). Un-ionized ammonia criteria for salt water are from EPA 440/5-88-004. Revised 19-Oct-

INPUT - Carkeek CSO TP	
1. Receiving Water Temperature, deg C (max 1DADMax):	14.0
2. Receiving Water pH, (max):	8.0
3. Receiving Water Salinity, g/kg (min):	26.1
4. Pressure, atm (EPA criteria assumes 1 atm):	1.0
5. Unionized ammonia criteria (mg un-ionized NH ₃ per liter) from EPA 440/5-88-004:	
Acute:	0.233
Chronic:	0.035
OUTPUT	
Using mixed temp and pH at mixing zone boundaries?	No
1. Molal Ionic Strength (not valid if >0.85):	0.534
2. pKa8 at 25 deg C (Whitfield model "B"):	9.307
3. Percent of Total Ammonia Present as Unionized:	2.1%
4. Total Ammonia Criteria (mg/L as NH ₃):	
Acute:	10.85
Chronic:	1.63
RESULTS	
Total Ammonia Criteria (mg/L as N)	
Acute:	8.92
Chronic:	1.34

Reasonable Potential Calculation

Facility	Carkeek CSO TP
Water Body Type	Marine

Dilution Factors:	Acute	Chronic
Aquatic Life	75.0	104
Human Health Carcinogenic		104
Human Health Non-Carcinogenic		104

Pollutant, CAS No. & NPDES Application Ref. No.		AMMONIA, Criteria as Total NH3	ANTIMONY (INORGANIC) 7440360 1M	ARSENIC (dissolved) 7440382 2M	BENZO(b)FLUORANTHENE 205992 7B	BENZO(k) FLUORANTHENE 207089 9B	BIS(2-ETHYLHEXYL) PHTHALATE 117817 13B	BUTYLBENZYL PHTHALATE 85687 15B	CADMIUM - 7440439 4M	CHLORINE (Total Residual) 7782505**	CHLOROFORM 67663 11V	CHROMIUM(HEX) 18540299*
Effluent Data	# of Samples (n)	4	10	10	5	5	9	9	10	11	8	10
	Coeff of Variation (Cv)	0.6	0.6	0.6	0.6	0.6	0.6	0.6	0.6	0.6	0.6	0.6
	Effluent Concentration, ug/L (Max. or 95th Percentile)	3,350	1.03	4.48	2.91	0.81	3.65	4.46	0.2	1370	64.3	5.68
	Calculated 50th percentile Effluent Conc. (when n>10)											
Receiving Water Data	90th Percentile Conc., ug/L	85		1.39					0.073	0		0.148
	Geo Mean, ug/L		0		0	0	0	0			0	
Water Quality Criteria	Aquatic Life Criteria, Acute ug/L	27,804	-	69	-	-	-	-	42	13	-	1100
	Chronic ug/L	4,177	-	36	-	-	-	-	9.3	7.5	-	50
	WQ Criteria for Protection of Human Health, ug/L	-	4300	-	0.031	0.031	5.9	1900	-	-	470	-
	Metal Criteria Acute Translator, decimal	-	-	1.000	-	-	-	-	0.980*	-	-	0.960*
	Chronic	-	-	-	-	-	-	-	0.980*	-	-	0.960*
Carcinogen?	N	N	Y	Y	Y	Y	N	N	N	Y	N	

Aquatic Life Reasonable Potential

Effluent percentile value		0.950	0.950	0.950	0.950	0.950
s	$s^2 = \ln(CV^2 + 1)$	0.555	0.555	0.555	0.555	0.555
Pn	$Pn = (1 - \text{confidence level})^{1/n}$	0.473	0.741	0.741	0.762	0.741
Multiplier		2.59	1.74	1.74	1.68	1.74
Max concentration (ug/L) at edge of...	Acute	199	1.475	1.475	30.651	0.272
	Chronic	167	1.452	1.452	22.104	0.238
Reasonable Potential?		NO	NO	NO	YES	NO

Human Health Reasonable Potential

s	$s^2 = \ln(CV^2 + 1)$	0.5545	0.5545	0.5545	0.5545	0.5545
Pn	$Pn = (1 - \text{confidence level})^{1/n}$	0.741	0.549	0.549	0.717	0.717
Multiplier		0.6986	0.9336	0.9336	0.7276	0.7276
Dilution Factor		104	104	104	104	104
Max Conc. at edge of Chronic Zone, ug/L		0.0069	0.0261	0.0073	2.6E-02	3.1E-02
Reasonable Potential?		NO	NO	NO	NO	NO*

Comments/Notes: *Translator derived from receiving water data. **Data only available for total chromium - conservative evaluation.

References: WAC 173-201A,

Technical Support Document for Water Quality-based Toxics Control, US EPA, March 1991, EPA/505/2-90-001, pages 56/99

Reasonable Potential Calculation - Page 2

Facility	Carkeek CSO TP
Water Body Type	Marine

Dilution Factors:	Acute	Chronic
Aquatic Life	75.0	104
Human Health Carcinogenic		104
Human Health Non-Carcinogenic		104

Pollutant, CAS No. & NPDES Application Ref. No.		COPPER - 744058 6M	2,4 DICHLOROPHENOL 120832 2A	DIETHYLPHTHALATE 84662 24B	DI-n-BUTYL PHTHALATE 84742 26B	LEAD - 7439921 7M	MERCURY 7439976 8M	NICKEL - 7440020 9M	SILVER - 7740224 11M	TOLUENE 108883 25V	ZINC- 7440666 13M	CYANIDE 57125 14M
Effluent Data	# of Samples (n)	10	9	9	9	10	10	10	10	8	10	17
	Coeff of Variation (Cv)	0.6	0.6	0.6	0.6	0.6	0.6	0.6	0.6	0.6	0.6	0.6
	Effluent Concentration, ug/L (Max. or 95th Percentile)	27.7	0.89	1.54	0.63	11.3	0.051	4.63	0.3	3.52	85	20.1
	Calculated 50th percentile Effluent Conc. (when n>10)											5
Receiving Water Data	90th Percentile Conc., ug/L	0.363				0.005	0.0002	0.424	0.027		0.643	0
	Geo Mean, ug/L		0	0	0		0.0002	0.408		0		0
Water Quality Criteria	Aquatic Life Criteria, Acute ug/L	4.8	-	-	-	210	1.8	74	1.9	-	90	9.1
	Chronic ug/L	3.1	-	-	-	8.1	0.025	8.2	-	-	81	2.8
	WQ Criteria for Protection of Human Health, ug/L	-	790	120000	12000	-	0.15	4600	-	200000	-	220000
	Metal Criteria Acute	0.790*	-	-	-	0.951	0.85	1.000*	0.85	-	0.946	-
	Translator, decimal Chronic	0.790*	-	-	-	0.951	-	1.000*	-	-	0.946	-
Carcinogen?	N	N	N	N	N	N	N	N	N	N	N	

Aquatic Life Reasonable Potential

Effluent percentile value		0.950				0.950	0.950	0.950	0.950		0.950	0.950
s	$s^2=\ln(CV^2+1)$	0.555				0.555	0.555	0.555	0.555		0.555	0.555
Pn	$Pn=(1-\text{confidence level})^{1/n}$	0.741				0.741	0.741	0.741	0.741		0.741	0.838
Multiplier		1.74				1.74	1.74	1.74	1.74		1.74	1.44
Max concentration (ug/L) at edge of...	Acute	0.866				0.254	0.001	0.526	0.033		2.499	0.386
	Chronic	0.725				0.185	0.001	0.497	0.032		1.981	0.278
Reasonable Potential?		NO				NO	NO	NO	NO		NO	NO

Human Health Reasonable Potential

s	$s^2=\ln(CV^2+1)$	0.5545	0.5545	0.5545		0.5545	0.5545		0.5545		0.5545	
Pn	$Pn=(1-\text{confidence level})^{1/n}$	0.717	0.717	0.717		0.741	0.741		0.688		0.838	
Multiplier		0.7276	0.7276	0.7276		0.6986	0.6986		0.7624		0.5782	
Dilution Factor			104	104	104		104	104		104		104
Max Conc. at edge of Chronic Zone, ug/L		0.0062	0.0108	0.0044		5.4E-04	4.4E-01		0.0258		0.0481	
Reasonable Potential?		NO	NO	NO		NO	NO		NO		NO	

Comments/Notes: *Translator derived from receiving water data.

References: WAC 173-201A,

Technical Support Document for Water Quality-based Toxics Control, US EPA, March 1991, EPA/505/2-90-001, pages 56/99

Aquatic Life and Human Health Limits Calculations

Facility	Carkeek CSO TP
Water Body Type	Marine

Dilution Factors:	Acute	Chronic
Aquatic Life	75	104
Human Health Carcinogenic		104
Human Health Non-Carcinogenic		104

Pollutant, CAS No. & NPDES Application Ref. No.		CHLORINE (Total Residual) 7782505	Chlorine Limit - 2004 Permit								
	Acute Dilution Factor	75	38								
Chronic Dilution Factor	104	197									
Effluent Data	Coeff of Variation (Cv)	0.6	0.6								
Receiving Water Data	90th Percentile Conc., ug/L	0	0								
	Geo Mean, ug/L										
Water Quality Criteria	Aquatic Life Criteria, Acute ug/L	13	13								
	Chronic	7.5	7.5								
	WQ Criteria for Protection of Human Health, ug/L	-	-								
	Metal Criteria Acute	-	-								
	Translator, decimal Chronic	-	-								
Carcinogen?	N	N									

Aquatic Life Limit Calculation

# of Compliance Samples Expected per month		4	4
LTA Coeff. Var. (CV), decimal		0.6	0.6
Permit Limit Coeff. Var. (CV), decimal		0.6	0.6
Waste Load Allocations, ug/L	Acute	975	494
	Chronic	780	1477.5
Long Term Averages, ug/L	Acute	313	159
	Chronic	411	779
Limiting LTA, ug/L		313	159
Metal Translator or 1?		1.00	1.00
Average Monthly Limit (AML), ug/L		486	246
Maximum Daily Limit (MDL), ug/L		975	494

Comments/Notes:

References: WAC 173-201A, Technical Support Document for Water Quality-based Toxics Control, US EPA, March 1991, EPA/505/2-90-001, pages 56/99

Marine Temperature Reasonable Potential and Limit Calculation

Based on WAC 173-201A-200(1)(c)(i)--(ii) and Water Quality Program Guidance. All Data inputs must meet WQ guidelines. The Water Quality temperature guidance document may be found at:
<http://www.ecy.wa.gov/biblio/0610100.html>

INPUT - Carkeek CSO TP	
1. Chronic Dilution Factor at Mixing Zone Boundary	10
2. Annual max 1DADMax Ambient Temperature (Background 90th percentile)	18.7 °C
3. 1DADMax Effluent Temperature (95th percentile)	21.0 °C
4. Aquatic Life Temperature WQ Criterion	16.0 °C
OUTPUT	
5. Temperature at Chronic Mixing Zone Boundary:	18.92 °C
6. Incremental Temperature Increase or decrease:	0.22 °C
7. Incremental Temperature Increase $12/(T-2)$ if $T \leq$ crit:	---
8. Maximum Allowable Temperature at Mixing Zone Boundary:	19.00 °C
A. If ambient temp is warmer than WQ criterion	
9. Does temp fall within this warmer temp range?	YES
10. Temp increase allowed at mixing zone boundary, if required:	NO LIMIT
B. If ambient temp is cooler than WQ criterion but within $12/(T_{amb}-2)$ and within 0.3 °C of the criterion	
11. Does temp fall within this incremental temp. range?	---
12. Temp increase allowed at mixing zone boundary, if required:	---
C. If ambient temp is cooler than (WQ criterion-0.3) but within $12/(T_{amb}-2)$ of the criterion	
13. Does temp fall within this Incremental temp. range?	---
14. Temp increase allowed at mixing zone boundary, if required:	---
D. If ambient temp is cooler than (WQ criterion - $12/(T_{amb}-2)$)	
15. Does temp fall within this Incremental temp. range?	---
16. Temp increase allowed at mixing zone boundary, if required:	---
RESULTS	
17. Do any of the above cells show a temp increase?	NO
18. Temperature Limit if Required?	NO LIMIT

Elliott West CSO Treatment Plant - Calculations

Calculation of pH of a Mixture in Marine Water

Based on the CO2SYS program (Lewis and Wallace, 1998), <http://cdiac.esd.ornl.gov/oceans/co2rprt.html>

INPUT - Elliott West CSO TP	
1. MIXING ZONE BOUNDARY CHARACTERISTICS	
Dilution factor at mixing zone boundary	9.7
Depth at plume trapping level (m)	1.000
2. BACKGROUND RECEIVING WATER CHARACTERISTICS	
Temperature (deg C):	13.40
pH:	7.40
Salinity (psu):	24.00
Total alkalinity (meq/L)	1.78
3. EFFLUENT CHARACTERISTICS	
Temperature (deg C):	21.00
pH:	5.50
Salinity (psu)	12.00
Total alkalinity (meq/L):	0.65
OUTPUT	
CONDITIONS AT THE MIXING ZONE BOUNDARY	
Temperature (deg C):	11.91
Salinity (psu)	22.67
Density (kg/m ³)	1017
Alkalinity (mmol/kg-SW):	1.63
Total Inorganic Carbon (mmol/kg-SW):	2
pH at Mixing Zone Boundary:	6.59

Calculation of Fecal Coliform at Chronic Mixing Boundary - Elliott West CSO TP

Technology-based limits		
For WWTPs: 200/400 monthly/weekly geomean		
For CSO TPs: 400 monthly geomean		
Effluent Fecal Coliform - worst case 400 #/100 mL		
Day of Month	Fecal Value	Limit
1	400	
2	400	
3	400	
4		
5		
6		
7		
8		
9		
10		
11		
12		
13		
14		
15		
16		
17		
18		
19		
20		
21		
22		
23		
24		
25		
26		
27		
28		
29		
30		
31		
Monthly Geomean =	400	400

WQ-based limits		
For WWTPs: 14/43 [+Dilution] monthly/daily geomean		
For CSO TPs: 14/43 [+Dilution] monthly/daily geomean. We typically compare monthly geomean limit (400) to 14 WQ Std. Since 14 is an assessment of the receiving water quality assessed on a <i>monthly</i> basis, we should include non-discharge days in this calculation.		
Chronic Dilution Factor	9.7	
Receiving Water Fecal Coliform	2.0	#/100 mL
Effluent Fecal Coliform - worst case	400	#/100 mL
Surface Water Criteria	14	#/100 mL
Day of Month	Fecal - Effluent	Fecal - Receiving Water @ Chronic Mixing Boundary
1	400	43
2	400	43
3	400	43
4	0	2
5	0	2
6	0	2
7	0	2
8	0	2
9	0	2
10	0	2
11	0	2
12	0	2
13	0	2
14	0	2
15	0	2
16	0	2
17	0	2
18	0	2
19	0	2
20	0	2
21	0	2
22	0	2
23	0	2
24	0	2
25	0	2
26	0	2
27	0	2
28	0	2
29	0	2
30	0	2
31	0	2
Monthly Geomean =		2.4

Marine Un-ionized Ammonia Criteria Calculation

Calculation of seawater fraction of un-ionized ammonia from Hampson (1977). Un-ionized ammonia criteria for salt water are from EPA 440/5-88-004. Revised 19-Oct-

INPUT	
1. Receiving Water Temperature, deg C (90th percentile):	13.4
2. Receiving Water pH, (90th percentile):	8.0
3. Receiving Water Salinity, g/kg (10th percentile):	24.0
4. Pressure, atm (EPA criteria assumes 1 atm):	1.0
5. Unionized ammonia criteria (mg un-ionized NH ₃ per liter) from EPA 440/5-88-004:	
Acute:	0.233
Chronic:	0.035
OUTPUT	
Using mixed temp and pH at mixing zone boundaries?	No
1. Molal Ionic Strength (not valid if >0.85):	0.490
2. pKa8 at 25 deg C (Whitfield model "B"):	9.302
3. Percent of Total Ammonia Present as Unionized:	2.1%
4. Total Ammonia Criteria (mg/L as NH ₃):	
Acute:	11.21
Chronic:	1.68
RESULTS	
Total Ammonia Criteria (mg/L as N)	
Acute:	9.22
Chronic:	1.38

Reasonable Potential Calculation

Dilution Factors:		Acute	Chronic
Aquatic Life		8.4	9.7
Human Health Carcinogenic			9.7
Human Health Non-Carcinogenic			9.7

Facility	Elliott West CSO TP
Water Body Type	Marine

Pollutant, CAS No. & NPDES Application Ref. No.		AMMONIA, Criteria as Total NH3	ANTIMONY (INORGANIC) 744036 1M	ARSENIC (dissolved) 7440382 2M	BIS(2-ETHYLHEXYL) PHTHALATE 117817 13B	BUTYLBENZYL PHTHALATE 8568 15B	CADMIUM - 7440439 4M	CHLOROFORM 67663 11V	CHROMIUM(HEX) 18540299**	COPPER - 744058 6M
Effluent Data	# of Samples (n)	2	20	20	9	9	20	8	20	20
	Coeff of Variation (Cv)	0.6	0.67	0.63	0.6	0.6	0.88	0.6	0.96	0.34
	Effluent Concentration, ug/L (Max. or 95th Percentile)	2,680		2.60	6.85	1.42	0.60	35.8	5.72	66
	Calculated 50th percentile Effluent Conc. (when n>10)		0.485							
Receiving Water Data	90th Percentile Conc., ug/L	0.085		1.39			0.72		0.14	0.49
	Geo Mean, ug/L		0		0	0		0		
Water Quality Criteria	Aquatic Life Criteria, Acute ug/L	9,216	-	69	-	-	42	-	1100	4.8
	Chronic	1,384	-	36	-	-	9.3	-	50	3.1
	WQ Criteria for Protection of Human Health, ug/L	-	4300	-	5.9	1900	-	470	-	-
	Metal Criteria, Acute	-	-	1.000	-	-	0.960*	-	0.993	0.790*
	Translator, decimal	-	-	-	-	-	0.960*	-	0.993	0.790*
	Carcinogen?	N	N	Y	Y	N	N	Y	N	N

Aquatic Life Reasonable Potential

Effluent percentile value		0.950	0.950	0.950	0.950	0.950
s	$s^2 = \ln(CV^2 + 1)$	0.555	0.578	0.757	0.808	0.331
Pn	$Pn = (1 - \text{confidence level})^{1/n}$	0.224	0.861	0.861	0.861	0.861
Multiplier		3.79	1.38	1.53	1.57	1.20
Max concentration (ug/L) at edge of...	Acute	1,211	1.65	0.739	1.2	7.9
	Chronic	1,048	1.62	0.737	1.0	6.9
Reasonable Potential?		NO	NO	NO	NO	YES

Human Health Reasonable Potential

s	$s^2 = \ln(CV^2 + 1)$	0.6089	0.5545	0.5545	0.5545
Pn	$Pn = (1 - \text{confidence level})^{1/n}$	0.861	0.717	0.717	0.688
Multiplier		0.5167	0.7276	0.7276	0.7624
Dilution Factor		9.7	9.7	9.7	9.7
Max Conc. at edge of Chronic Zone, ug/L		0.05	5.1E-01	0.11	2.81
Reasonable Potential?		NO	NO	NO	NO

Comments/Notes: *Translator derived from receiving water data. **Data only available for total chromium - conservative evaluation.

References: WAC 173-201A,

Technical Support Document for Water Quality-based Toxics Control, US EPA, March 1991, EPA/505/2-90-001, pages 56/99

Reasonable Potential Calculation - Page 2

Facility	Elliott West CSO TP
Water Body Type	Marine

Dilution Factors:	Acute	Chronic
Aquatic Life	8.4	9.7
Human Health Carcinogenic		9.7
Human Health Non-Carcino		9.7

Pollutant, CAS No. & NPDES Application Ref. No.		1,4 DICHLOROBENZENE 106467	DICHLOROBROMOMETHANE 75274 12V	2,4 DICHLOROPHENOL 120832	DIETHYLPHTHALATE 84662 24E	DIMETHYLPHTHALATE 131113	FLUORANTHENE 206440 31B	LEAD - 7439921 7M	MERCURY 7439976 8M	NICKEL - 7440020 9M	PENTACHLOROPHENOL 87865
		22B	12V	2A		25B					9A
Effluent Data	# of Samples (n)	8	8	9	9	9	9	20	10	20	9
	Coeff of Variation (Cv)	0.6	0.6	0.6	0.6	0.6	0.6	1.14	0.301	0.88	0.6
	Effluent Concentration, ug/L (Max. or 95th Percentile)	8.16	2	1	5.47	0.4	0.6	23.6	0.088	4.887	1.91
	Calculated 50th percentile Effluent Conc. (when n>10)								0.05	2.16	
Receiving Water Data	90th Percentile Conc., ug/L							0.005	0.0002	0.432	0
	Geo Mean, ug/L	0	0	0	0	0	0		0.0002	0.410	0
Water Quality Criteria	Aquatic Life Criteria, Acute ug/L	-	-	-	-	-	-	210	1.8	74	13
	Aquatic Life Criteria, Chronic ug/L	-	-	-	-	-	-	8.1	0.025	8.2	7.9
	WQ Criteria for Protection of Human Health, ug/L	2600	22	790	120000	3E+06	370	-	0.15	4600	8.2
	Metal Criteria, Acute Translator, decimal	-	-	-	-	-	-	0.951	0.85	0.970*	-
	Metal Criteria, Chronic Translator, decimal	-	-	-	-	-	-	0.951	-	0.970*	-
	Carcinogen?	N	Y	N	N	N	N	N	N	N	Y

Aquatic Life Reasonable Potential

Effluent percentile value		0.950	0.950	0.950	0.950
s	$s^2=\ln(CV^2+1)$	0.913	0.294	0.757	0.555
Pn	$Pn=(1-\text{confidence level})^{1/n}$	0.861	0.741	0.861	0.717
Multiplier		1.67	1.34	1.53	1.81
Max concentration (ug/L) at edge of...	Acute	4.455	0.012	1.243	0.412
	Chronic	3.9	0.012	1.13	0.36
Reasonable Potential?		NO	NO	NO	NO

Human Health Reasonable Potential

s	$s^2=\ln(CV^2+1)$	0.5545	0.5545	0.5545	0.5545	0.5545	0.55451	0.2945	0.7573	0.5545
Pn	$Pn=(1-\text{confidence level})^{1/n}$	0.688	0.688	0.717	0.717	0.717	0.717	0.741	0.861	0.717
Multiplier		0.7624	0.7624	0.7276	0.7276	0.7276	0.72756	0.82655	0.4399	0.7276
Dilution Factor		9.7	9.7	9.7	9.7	9.7	9.7	9.7	9.7	9.7
Max Conc. at edge of Chronic Zone, ug/L		0.64	0.16	0.08	0.41	0.03	0.045	0.00533	0.5904	0.14
Reasonable Potential?		NO	NO	NO	NO	NO	NO	NO	NO	NO

Comments/Notes: *Translator derived from receiving water data.

References: WAC 173-201A,

Technical Support Document for Water Quality-based Toxics Control, US EPA, March 1991, EPA/505/2-90-001, pages 56/99

Reasonable Potential Calculation - Page 3

Facility	Elliott West CSOTP
Water Body Type	Marine

Dilution Factors:	Acute	Chronic
Aquatic Life	8.4	9.7
Human Health Carcinogenic		9.7
Human Health Non-Carcinogenic		9.7

Pollutant, CAS No. & NPDES Application Ref. No.		PYRENE 129000 45B	SELENIUM 7782492 10M	SILVER - 7740224 11M	THALLIUM 7440280 12M	TOLUENE 108883 25V	ZINC- 7440666 13M	CHLORINE (Total Residual) 7782505	CYANIDE 57125 14M	CYANIDE 57125 14M*
Effluent Data	# of Samples (n)	9	20	20	20	8	20	25	11	10
	Coeff of Variation (Cv)	0.6	0.049	1.55	1.0	0.6	0.858	1.6	0.64	0.64
	Effluent Concentration, ug/L (Max. or 95th Percentile)	0.600	0.5055	0.7914		32.8	161.1	860	19.3	11.8
	Calculated 50th percentile Effluent Conc. (when n>10)		0.500		0.040				5.0	5.0
Receiving Water Data	90th Percentile Conc., ug/L		0	0.028			0.995	0	0	0
	Geo Mean, ug/L	0	0		0	0			0	0
Water Quality Criteria	Aquatic Life Criteria, Acute ug/L	-	290	1.9	0.00	-	90	13	9.1	9.1
	Chronic	-	71	-	-	-	81	7.5	2.8	2.8
	WQ Criteria for Protection of Human Health, ug/L	11000	4200	-	6.3	200000	-	-	220000	220000
	Metal Criteria Acute	-	-	0.85	-	-	0.946	-	-	-
	Translator, decimal Chronic	-	-	-	-	-	0.946	-	-	-
	Carcinogen?	N	N	N	N	N	N	N	N	N

Aquatic Life Reasonable Potential

Effluent percentile value		0.950	0.950		0.950	0.95	0.950	0.950
s	$s^2=\ln(CV^2+1)$	0.049	1.107		0.743	1.13	0.586	0.586
Pn	$Pn=(1-\text{confidence level})^{1/n}$	0.861	0.861		0.861	0.89	0.762	0.741
Multiplier		1.03	1.86		1.52	1.00	1.73	1.79
Max concentration (ug/L) at edge of...	Acute	0.062	0.17		28.4	102	3.970	2.521
	Chronic	0.054	0.18		24.7	89	3.438	2.183
Reasonable Potential?		NO	NO		NO	YES	YES	NO

Human Health Reasonable Potential

s	$s^2=\ln(CV^2+1)$	0.5545	0.049	0.8326	0.5545		0.5859	0.5859
Pn	$Pn=(1-\text{confidence level})^{1/n}$	0.717	0.861	0.861	0.688		0.762	0.741
Multiplier		0.7276	0.9483	0.4054	0.7624		0.6591	0.6845
Dilution Factor		9.7	9.7	9.7	9.7		9.7	9.7
Max Conc. at edge of Chronic Zone, ug/L		0.045	0.052	0.0041	2.6		0.5155	0.5155
Reasonable Potential?		NO	NO	NO	NO		NO	NO

Comments/Notes: *Cyanide below detection limit in 8 of 11 samples. Second column show s RP with max value discarded as potential outlier.

References: WAC 173-201A,

Technical Support Document for Water Quality-based Toxics Control, US EPA, March 1991, EPA/505/2-90-001, pages 56/99

Chlorine Limit Calculation

Facility	Elliott West CSO TP
Water Body Type	Marine

Dilution Factors:	Acute	Chronic
Aquatic Life	8.4	9.7
Human Health Carcinogenic		9.7
Human Health Non-Carcinogenic		9.7

Pollutant, CAS No. & NPDES Application Ref. No.		CHLORINE (Total Residual) 7782505						
Effluent Data	Coeff of Variation (Cv)	1.6						
Receiving Water Data	90th Percentile Conc., ug/L	0						
	Geo Mean, ug/L	0						
Water Quality Criteria	Aquatic Life Criteria, Acute ug/L	13						
	Chronic	7.5						
	WQ Criteria for Protection of Human Health, ug/L	-						
	Metal Criteria Acute	-						
	Translator, decimal Chronic	-						
	Carcinogen?	N						

Aquatic Life Limit Calculation

# of Compliance Samples Expected per month		4
LTA Coeff. Var. (CV), decimal		1.6
Permit Limit Coeff. Var. (CV), decimal		1.6
Waste Load Allocations, ug/L	Acute	109
	Chronic	73
Long Term Averages, ug/L	Acute	15
	Chronic	18
Limiting LTA, ug/L		15
Metal Translator or 1?		1
Average Monthly Limit (AML), ug/L		37
Maximum Daily Limit (MDL), ug/L		109

Comments/Notes:

References: WAC 173-201A,

Technical Support Document for Water Quality-based Toxics Control, US EPA, March 1991, EPA/505/2-90-001, pag

Marine Temperature Reasonable Potential and Limit Calculation

Based on WAC 173-201A-200(1)(c)(i)--(ii) and Water Quality Program Guidance. All Data inputs must meet WQ guidelines. The Water Quality temperature guidance document may be found at:

<http://www.ecy.wa.gov/biblio/0610100.html>

INPUT - Elliott West CSO TP	
1. Chronic Dilution Factor at Mixing Zone Boundary	9.7
2. Annual max 1DADMax Ambient Temperature (Background 90th percentile)	13.4 °C
3. 1DADMax Effluent Temperature (95th percentile)	21.0 °C
4. Aquatic Life Temperature WQ Criterion	16.0 °C
OUTPUT	
5. Temperature at Chronic Mixing Zone Boundary:	14.18 °C
6. Incremental Temperature Increase or decrease:	0.78 °C
7. Incremental Temperature Increase $12/(T-2)$ if $T \leq \text{crit}$:	1.05 °C
8. Maximum Allowable Temperature at Mixing Zone Boundary:	14.45 °C
A. If ambient temp is warmer than WQ criterion	
9. Does temp fall within this warmer temp range?	NO
10. Temp increase allowed at mixing zone boundary, if required:	---
B. If ambient temp is cooler than WQ criterion but within $12/(T_{\text{amb}}-2)$ and within 0.3 °C of the criterion	
11. Does temp fall within this incremental temp. range?	NO
12. Temp increase allowed at mixing zone boundary, if required:	---
C. If ambient temp is cooler than (WQ criterion-0.3) but within $12/(T_{\text{amb}}-2)$ of the criterion	
13. Does temp fall within this Incremental temp. range?	NO
14. Temp increase allowed at mixing zone boundary, if required:	---
D. If ambient temp is cooler than (WQ criterion - $12/(T_{\text{amb}}-2)$)	
15. Does temp fall within this Incremental temp. range?	YES
16. Temp increase allowed at mixing zone boundary, if required:	NO LIMIT
RESULTS	
17. Do any of the above cells show a temp increase?	NO
18. Temperature Limit if Required?	NO LIMIT

Henderson/MLK CSO Treatment Plant - Calculations

Streeter-Phelps Analysis of Critical Dissolved Oxygen Sag for the Henderson/MLK CSO TP

INPUT		Comments
1. EFFLUENT CHARACTERISTICS		
Discharge (mgd):	25	From KC's chronic mixing model.
Discharge (cfs):	39	
CBOD ₅ (mg/L):	20	Conservative estimate - no permit limit - max BOD5 measured = 16 mg/L
NBOD (mg/L):	3.3	Conservative estimate - max NH3 measured = 0.73 mg/L
Dissolved Oxygen (mg/L):	8	Conservative estimate - min DO measured = 8.4 mg/L
Temperature (deg C):	21	No data, used West Pt effluent data
2. RECEIVING WATER CHARACTERISTICS		
Upstream Discharge (cfs):	309	Used 10th percentile of daily mean values from 1995-2004 from USGS data site. Likely conservative because CSOs usually discharge in winter when flows are higher.
Upstream CBOD ₅ (mg/L):	1.0	Conservative estimate - no data
Upstream NBOD (mg/L):	0.2	Conservative estimate - no data
Upstream Dissolved Oxygen (mg/L):	7.5	KC 2013 Receiving water data report, 10th percentile value.
Upstream Temperature (deg C):	18.7	KC 2013 Receiving water data report, 1DADMax
Elevation (ft NGVD):	10	Estimate - small impact on results between 0 and 100
Downstream Average Channel Slope (ft/ft):	0.00088	
Downstream Average Channel Depth (ft):	12	USGS site: Duwamish River at Golf Course in Tukwila
Downstream Average Channel Velocity (fps):	0.26	From KC mixing model, min current = 7.8 cm/s.
3. REAERATION RATE (Base e) at 20 deg C (day⁻¹):		
	0.39	
	Applic.	Applic.
	Vel (fps)	Dep (ft)
<u>Reference</u>	<u>Vel (fps)</u>	<u>Dep (ft)</u>
Churchill	1.5 - 6	2 - 50
O'Connor and Dobbin	0.1 - 1.5	2 - 50
Owens	0.1 - 6	1 - 2
Tsivoglou-Wallace	0.1 - 6	0.1 - 2
		<u>Suggested Values</u>
		0.05
		0.16
		0.09
		0.93
4. BOD DECAY RATE (Base e) AT 20 deg C (day⁻¹):		
	0.23	
(or use Wright and McDonnell eqn, 1979, for small river)	0.59	
OUTPUT		
1. INITIAL MIXED RIVER CONDITION		
CBOD ₅ (mg/L):	3.1	
NBOD (mg/L):	0.5	
Dissolved Oxygen (mg/L):	7.6	
Temperature (deg C):	19.0	
2. TEMPERATURE ADJUSTED RATE CONSTANTS (Base e)		
Reaeration (day ⁻¹):	0.38	
BOD Decay (day ⁻¹):	0.22	
3. CALCULATED INITIAL ULTIMATE CBODU AND TOTAL BODU		
Initial Mixed CBODU (mg/L):	4.6	
Initial Mixed Total BODU (CBODU + NBOD, mg/L)	5.1	
4. INITIAL DISSOLVED OXYGEN DEFICIT		
Saturation Dissolved Oxygen (mg/L):	9.281	
Initial Deficit (mg/L):	1.73	
5. TRAVEL TIME TO CRITICAL DO CONCENTRATION		
	1.64	
6. DISTANCE TO CRITICAL DO CONCENTRATION (
	6.86	
7. CRITICAL DO DEFICIT (mg/L):		
	2.05	
8. CRITICAL DO CONCENTRATION (mg/L):		
	7.23	

Calculation of pH of a Mixture of Two Flows

Based on the procedure in EPA's DESCONE program (EPA, 1988. Technical Guidance on Supplementary Stream Design Conditions for Steady State Modeling. USEPA Office of Water, Washington D.C.)

INPUT - Henderson / MLK CSO TP	
1. Dilution Factor at Mixing Zone Boundary	10.3
2. Ambient/Upstream/Background Conditions	
Temperature (deg C):	18.70
pH:	7.30
Alkalinity (mg CaCO ₃ /L):	25.29
3. Effluent Characteristics	
Temperature (deg C)*:	18.00
pH:	7.00
Alkalinity (mg CaCO ₃ /L):	33.50
OUTPUT	
1. Ionization Constants	
Upstream/Background pKa:	6.39
Effluent pKa:	6.40
2. Ionization Fractions	
Upstream/Background Ionization Fraction:	0.89
Effluent Ionization Fraction:	0.80
3. Total Inorganic Carbon	
Upstream/Background Total Inorganic Carbon (mg CaCO ₃ /L):	28
Effluent Total Inorganic Carbon (mg CaCO ₃ /L):	42
4. Conditions at Mixing Zone Boundary	
Temperature (deg C):	18.63
Alkalinity (mg CaCO ₃ /L):	26.09
Total Inorganic Carbon (mg CaCO ₃ /L):	29.72
pKa:	6.39
RESULTS	
pH at Mixing Zone Boundary:	7.25

* estimated value, no data available, small impact on results

Calculation of Fecal Coliform at Chronic Mixing Zone

INPUT - Henderson CSO TP		
Chronic Dilution Factor	10.3	
Receiving Water Fecal Coliform, #/100 ml	110	KC 2013 receiving water study (max minus outlier)
Effluent Fecal Coliform - worst case, #/100 ml	400	Guidance-based limit
Surface Water Criteria, #/100 ml	200	<i>Freshwater secondary contact</i>
OUTPUT		
Fecal Coliform at Mixing Zone Boundary, #/100 ml	138	<200
Difference between mixed and ambient, #/100 ml	28	

Aquatic Life and Human Health Limits Calculations

Facility	Henderson CSO TP
Water Body Type	Marine

Dilution Factors:	Acute	Chronic
Aquatic Life	1.9	10.3
Human Health Carcinogenic		10.3
Human Health Non-Carcinogenic		10.3

Pollutant, CAS No. & NPDES Application Ref. No.	CHLORINE (Total Residual) 7782505							
Acute Dilution Factor	1.9							
Chronic Dilution Factor	10.3							
Effluent Data	Coeff of Variation (Cv)	0.6						
Receiving Water Data	90th Percentile Conc., ug/L	0						
	Geo Mean, ug/L							
Water Quality Criteria	Aquatic Life Criteria, Acute ug/L	13						
	Chronic ug/L	7.5						
	WQ Criteria for Protection of Human Health, ug/L	-						
	Metal Criteria, Acute	-						
	Translator, decimal, Chronic	-						
	Carcinogen?	N						

Aquatic Life Limit Calculation

# of Compliance Samples Expected per month		4
LTA Coeff. Var. (CV), decimal		0.6
Permit Limit Coeff. Var. (CV), decimal		0.6
Waste Load Allocations, ug/L	Acute	24.7
	Chronic	77.3
Long Term Averages, ug/L	Acute	7.9
	Chronic	40.7
Limiting LTA, ug/L		7.9
Metal Translator or 1?		1.00
Average Monthly Limit (AML), ug/L		12
Maximum Daily Limit (MDL), ug/L		25

Comments/Notes:

References: WAC 173-201A,

Technical Support Document for Water Quality-based Toxics Control, US EPA, March 1991, EPA/505/2-90-001, pages 56/99

Marine Temperature Reasonable Potential and Limit Calculation

Based on WAC 173-201A-200(1)(c)(i)--(ii) and Water Quality Program Guidance. All Data inputs must meet WQ guidelines. The Water Quality temperature guidance document may be found at:

<http://www.ecy.wa.gov/biblio/0610100.html>

INPUT - Henderson/MLK CSO TP	
1. Chronic Dilution Factor at Mixing Zone Boundary	10.3
2. Annual max 1DADMax Ambient Temperature (Background 90th percentile)	18.7 °C
3. 1DADMax Effluent Temperature (95th percentile)	21.0 °C
4. Aquatic Life Temperature WQ Criterion	16.0 °C
OUTPUT	
5. Temperature at Chronic Mixing Zone Boundary:	18.92 °C
6. Incremental Temperature Increase or decrease:	0.22 °C
7. Incremental Temperature Increase $12/(T-2)$ if $T \leq$ crit:	---
8. Maximum Allowable Temperature at Mixing Zone Boundary:	19.00 °C
A. If ambient temp is warmer than WQ criterion	
9. Does temp fall within this warmer temp range?	YES
10. Temp increase allowed at mixing zone boundary, if required:	NO LIMIT
B. If ambient temp is cooler than WQ criterion but within $12/(T_{amb}-2)$ and within 0.3 °C of the criterion	
11. Does temp fall within this incremental temp. range?	---
12. Temp increase allowed at mixing zone boundary, if required:	---
C. If ambient temp is cooler than (WQ criterion-0.3) but within $12/(T_{amb}-2)$ of the criterion	
13. Does temp fall within this Incremental temp. range?	---
14. Temp increase allowed at mixing zone boundary, if required:	---
D. If ambient temp is cooler than (WQ criterion - $12/(T_{amb}-2)$)	
15. Does temp fall within this Incremental temp. range?	---
16. Temp increase allowed at mixing zone boundary, if required:	---
RESULTS	
17. Do any of the above cells show a temp increase?	NO
18. Temperature Limit if Required?	NO LIMIT

Appendix G — Significant Industrial Users

Company Name	Permit Number	Local Limits	Categorical Limits	If categorical, which category and sub-category
Acu-Line Corporation	7231-04	No	Yes	Metal Finishing - CFR 433 PSNS
Alaskan Copper Works - 6th Ave.	7238-05	No	Yes	Metal Finishing - CFR 433
Alaskan Copper Works - Marginal Way	7201-04	No	Yes	Metal Finishing - CFR 433
Amgen Corporation (Seattle)	7785-02	Yes	No	
Art Brass Plating, Inc.	7722-04	No	Yes	Metal Finishing - CFR 433 PSNS
ASKO Processing Inc.	7728-03	No	Yes	Metal Finishing - CFR 433
BNSF Railway Co. - Interbay Facility	7872-01	Yes	No	
Boeing Commercial Airplane - North Field	7594-05	No	Yes	Metal Finishing - CFR 433
Boeing Company - Plant 2 Facility	7811-03	No	Yes	Metal Finishing - CFR 433 PSNS
BP West Coast Products, LLC	7592-04	Yes	No	
Carl Zapffe, Inc.	7654-03	No	Yes	Metal Finishing - CFR 433 PSNS
Ceradyne Inc. - Viox Glass Technology	7507-04	Yes	No	
Darigold, Inc. - Rainier Plant	7116-05	Yes	No	
Emerald Services Inc. - Airport Way Facility	7884-01	No	Yes	Centralized Waste Treatment 437,ABC PSES
Emerald Services Inc. - Marginal Way Facility	7725-04	Yes	No	
Encore Oils, LLC	7751-04	Yes	No	
Foss Maritime Company	7703-04	Yes	No	
Glacier Northwest Inc.	7740-03	Yes	No	
GM Nameplate Inc.	7187-05	No	Yes	Metal Finishing - CFR 433
Industrial Container Services	7130-04	Yes	No	
IRIS Holdings LLC - 5th Ave. N. Ph 2 Construction Site	7871-01	Yes	No	
Kerry Food & Beverage	7854-01	Yes	No	
King County SWD - Shoreline Transfer Station	7587-05	Yes	No	
King County SWD - Vashon Transfer Station	7675-04	Yes	No	
King County WTD - Ballard Siphon Replacement Project	7849-01	Yes	No	
Magnetic and Penetrant Services Co.	7873-01	No	Yes	Metal Finishing - CFR 433 PSNS
Marel Seattle, Inc.	7821-02	No	Yes	Metal Finishing - CFR 433 PSNS
Marine Vacuum Service, Inc.	7676-05	No	Yes	Centralized Waste Treatment 437D PSES
Mastercraft Metal Finishing, Inc.	7233-03	No	Yes	Electroplating - CFR 413
National Products Inc.	7834-02	No	Yes	Metal Finishing - CFR 433 PSNS
Pacific Iron and Metal	7577-04	Yes	No	
Pepsi Beverages Company - Seattle Facility	7820-02	Yes	No	
Pioneer Industries	7723-04	No	Yes	Metal Finishing - CFR 433 PSNS
Rabanco Recycling Company	7595-05	Yes	No	
Seattle Barrel Company	7113-03	Yes	No	
Seattle, City of - SDOT - Mercer Corridor Improvements	7863-01	Yes	No	
Seattle, City of - SPU - South Transfer Station	7878-01	Yes	No	
Skills, Inc. - Ballard Facility	7552-03	No	Yes	Electroplating - CFR 413
Sound Transit - Capitol Hill Station Location	7860-02	Yes	No	
Sound Transit - U830 Tunneling Pine Street Location	7859-01	Yes	No	
Sound Transit - University of Washington Station Location	7861-02	Yes	No	
TOC Holdings Co.	7689-07	Yes	No	
U.S. Starcraft Corporation	9711-01	No	Yes	Metal Finishing - CFR 433
University of Washington Microfabrication Facility	7800-02	No	Yes	Electronic Components - CFR 469
University of Washington School of Dentistry	7797-03	Yes	No	
Vigor Shipyards, Inc.	7782-06	Yes	No	
WSDOT - Alaskan Way Viaduct Replacement Project, SR99 Bored Tunnel	7875-01	Yes	No	
WSDOT - Viaduct - S. Holgate St. to S. King St. Stage 3 Atlantic Bypass Project	7877-01	Yes	No	

Appendix H — Process Flow Diagrams

West Point WWTP

West Point Treatment Plant

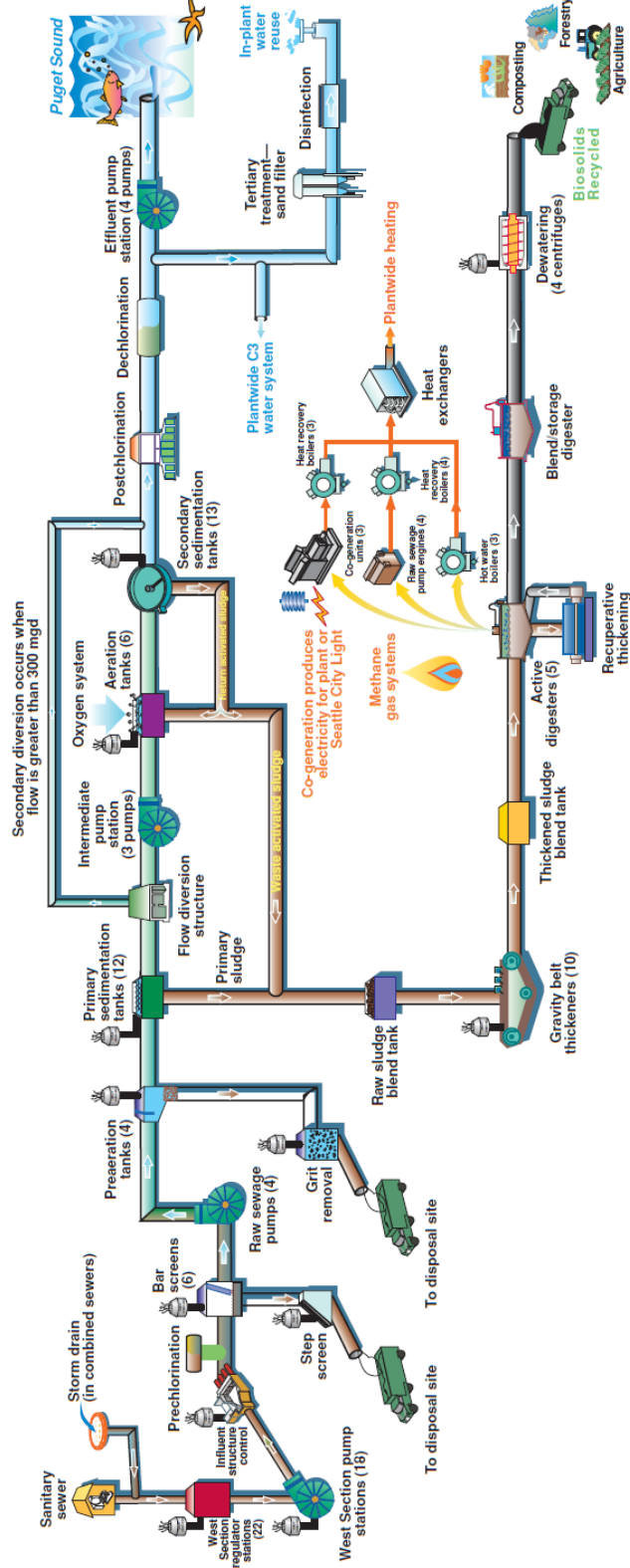

Alki CSO Treatment Plant

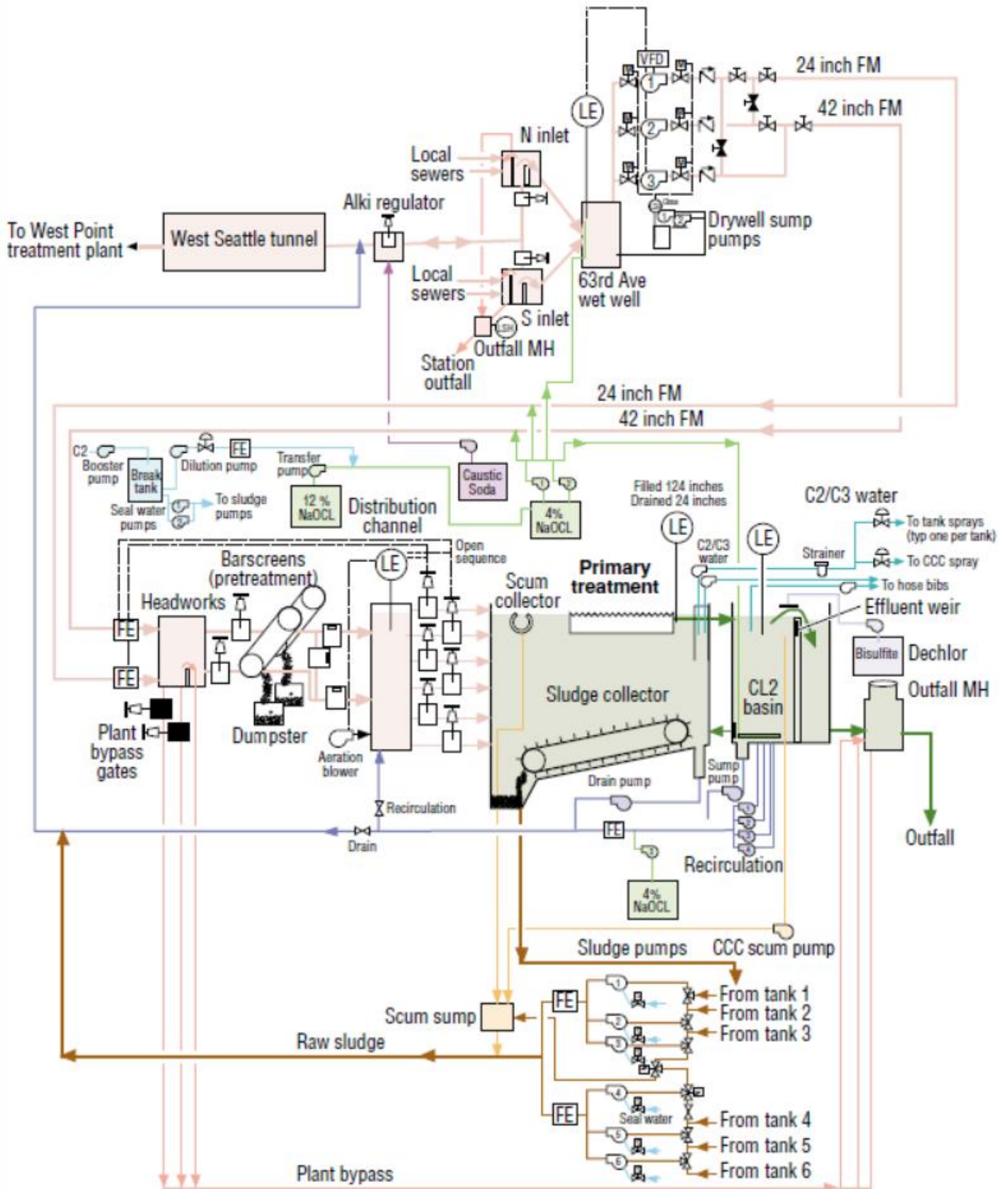

Carkeek CSO Treatment Plant

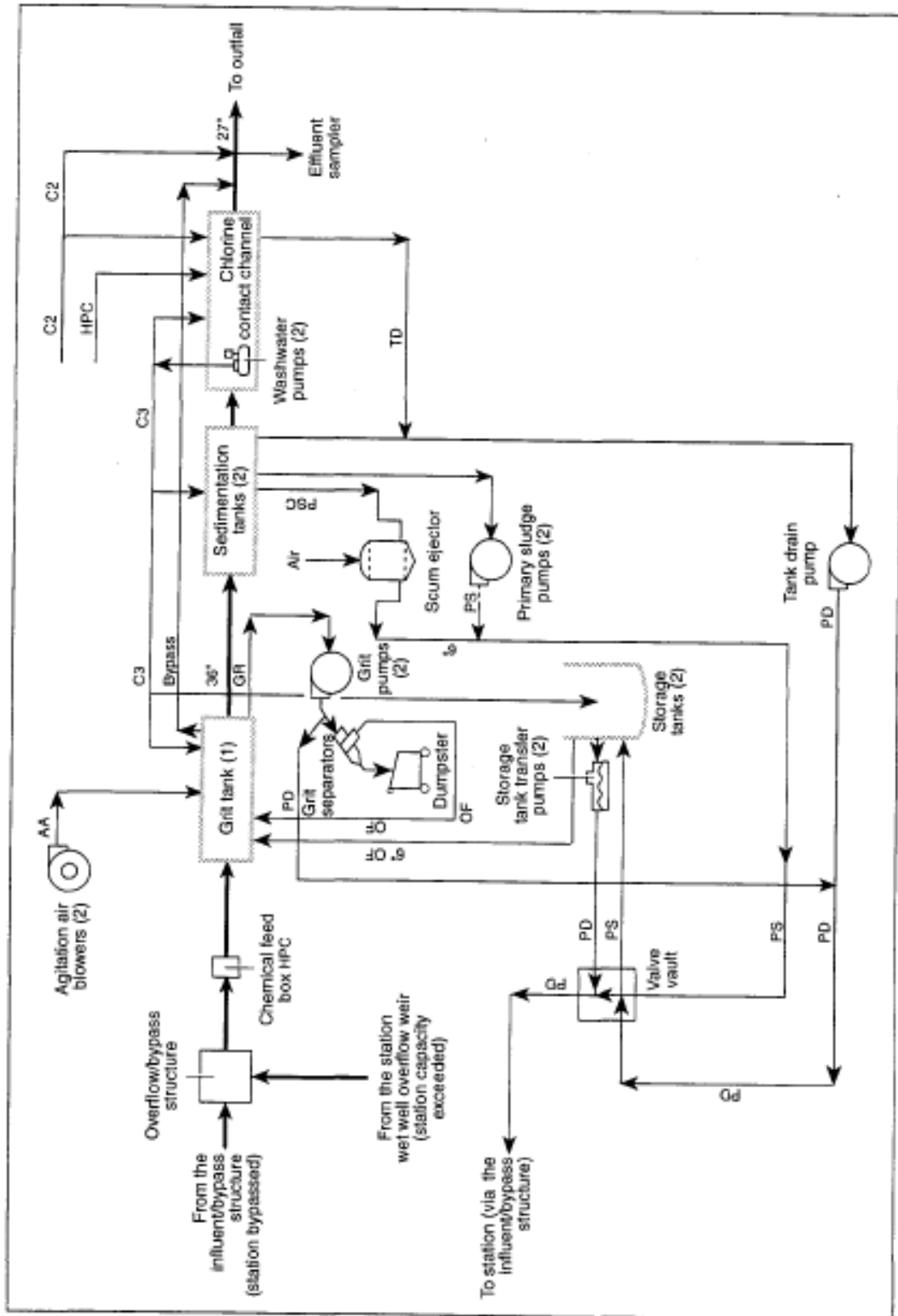

Elliott West CSO Treatment Plant

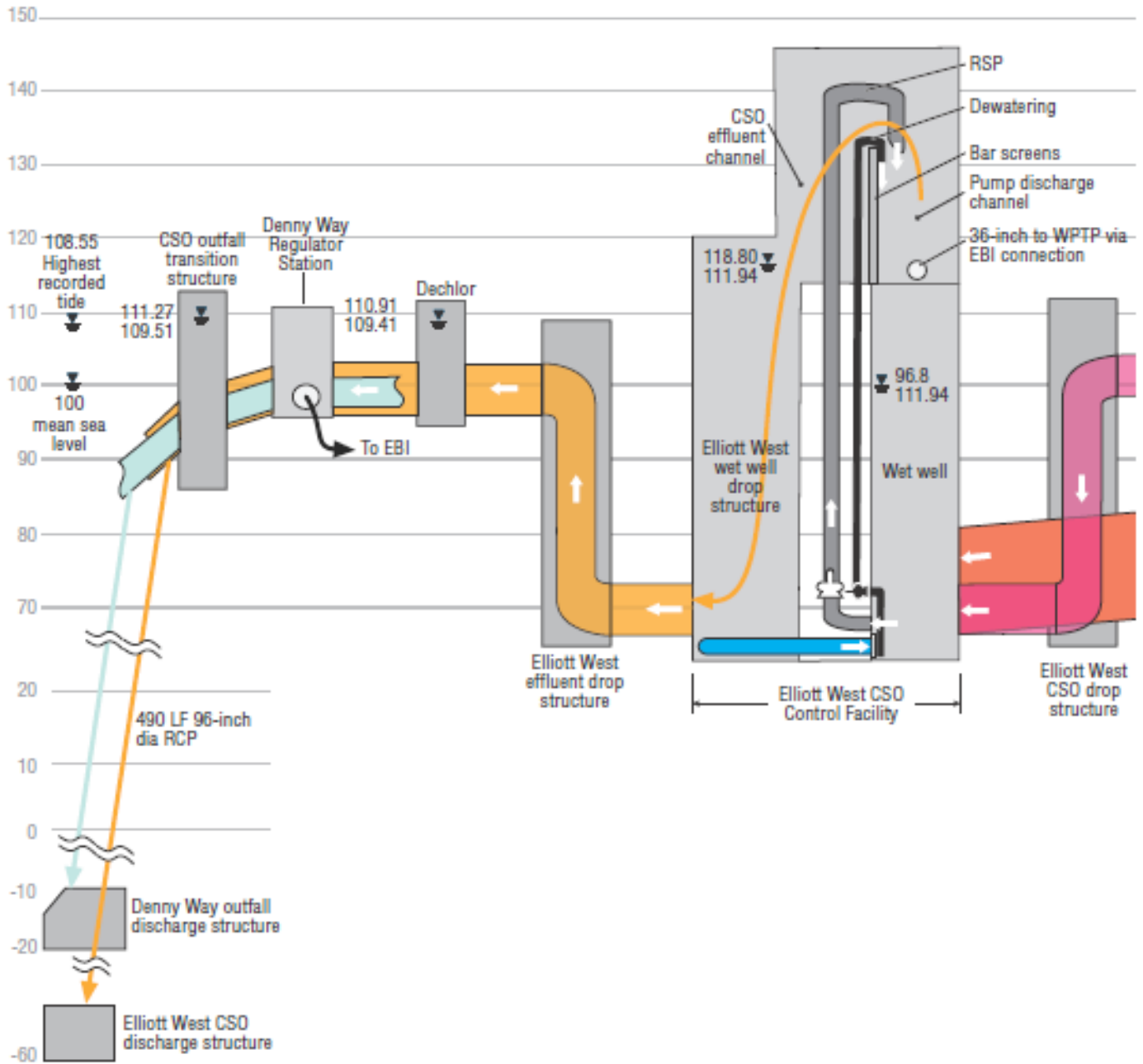

Appendix I — Response to Comments

King County Entity Review Comments

Significant comments are listed below; comments that provided clarification and/or corrections are not listed.

Number	Page	Section/ permit or factsheet	KC Comments	KC Suggested Resolution/Change	KC commenters name	Ecology Response
2	5	S1.A	Request retention of the permit allowance that allows for a reduction in removal % during wet weather. During wet weather conditions, there are two forces that make compliance more difficult. With high flows, (1) the influent becomes more dilute and has demonstrated concentrations close to proposed limit in 2012/13 (examples listed below), the higher the flow is above 300 mgd, the higher the % of primary effluent in the blended effluent. Also the potential for the screenings project representing and new potential reduction in TSS in influent that could compound the effect of wet weather highly dilute flows.	Permit Comments Retain the 80% removal during wet weather. Propose a "floor" to the effluent concentration limit, when the removal % is applied. 20 mg/L for both (a) higher floor for cBOD, relative to its normal effluent primary treatment)	Eugene Sugita/ Betsy Cooper	Added the following to permit: Calculations show that due to dilute influent at West Point during wet weather, effluent TSS and CBO5 average monthly effluent concentrations would have to be 13% and 19% lower, on average, than their respective discharge limits (80/25 mg/L) 36 and 49 percent of the time, respectively, to meet the 85% removal requirement. Ecology calculated these values using average monthly influent concentrations over the past 5 years. According to the EPA Permit Writer's Manual (page 5-11), this criteria qualifies the West Point facility for less stringent permit removal requirements, consistent with 40 CFR 133.103(a). Ecology has assessed, based on historical data, that the West Point facility can achieve 80% removal for TSS and CBO5 during the wet weather months of November through April.
3	5	S1.A	(1) - Several times during this current permit period, the effluent limits were driven below the 30 mg/L for TSS and 25 for cBOD. If the 85% removal limit was in effect, the limits would have been even lower. For example, in December 2012 - the cBOD limit would be 13 mg/L and the TSS limit 19 mg/L.		Eugene Sugita	
4	5	S1.A	(2) - At 350 MGD, the plant would be below 85%, with a 90% removal assumed for the secondary, and 55% for the primary treated flow. Also, although 50% removal is in the primary treatment definition, this should only apply to TSS. BOD removals are typically much lower with primary treatment - in the 25 to 35% range.		Eugene Sugita	
5	5	S1.A	Anticipated changes during the upcoming permit period that would also impact the % removal. Screenings project - the improved screenings removes more material from the influent, and the influent sample is taken downstream of the screens. Climate change / Seattle CSOs - anticipating higher flows (resulting in more dilute influent flows, and a higher % of treated CSO)		Eugene Sugita	
6	6 thru 9	S1.B	Footnote c, consider adding the addition in green to this footnote - For the monthly geometric mean, calculate the geometric mean of all samples collected during the month; use a value of 1 for the geometric calc when fecal coliform results are 0. Do not include non-discharge days in the calculation. Ecology provides directions to calculate this value in publication No. 04-10-020, Information Manual for Treatment Plant Operators. available at: http://www.ecy.wa.gov/pubs/0410020.pdf	For the monthly geometric mean, calculate the geometric mean of all samples collected during the month; use a value of 1 for the geometric calc when fecal coliform results are 0. In this calculation include days in which influent samples are collected or discharge occurs. For influent only days, include a value of 1 for the geometric value. Do not include non-discharge days in the calculation. Ecology provides directions to calculate this value in publication No. 04-10-020, Information Manual for Treatment Plant Operators.	Karl Zimmer	no - have 400 tech based limit
8	6 thru 9	S1.B	Applies to each CSO facility. Footnote d - report the instantaneous max and min pH monthly. The monthly limits for pH are 6 and 9.	Propose the EPA language / previous permit language, which allowed for brief excursions. From previous permit - "Indicates the range of permitted values. When pH is continuously monitored, excursions between 5.0 and 6.0, or 9.0 and 10.00 shall not be considered violations provided no single excursion exceeds 60 minutes in length and total excursions do not exceed 7 hours and 30 minutes per month. Any excursions below 5.0 and above 10.0 are violations. The instantaneous maximum and minimum pH shall be reported monthly.	Eugene Sugita	Cannot change - will set precedent, if allowed 7 hours of exceedance per month no need to monitor Ecology will keep using enforcement discretion.
9	10	S2.A Intro Paragraph	Need to discuss the effect the revision of this paragraph has on the affect monitoring for this permit, Treatment Plant Effluent and CSO Effluent. KC believes there may be difficulty meeting some of the DLs and QLS for parameters in Appendix A for secondary effluent. Further the extension of these DLs and QLS to CSO effluent raises additional concerns that such DLs and QLS would not be applicable and that no one matrix-specific study could be expected to capture the variability of CSO effluent quality. While KC agrees that methods with sufficient sensitivity should always be applied all sample analyses and seek the best sensitivity to assure our Pre-treatment has the best data on which to base limit and so all our effluents are thoroughly characterized, we are concerned if the well executed laboratory testing done consistently at the KC Environmental Lab is considered in violation of our NPDES permit conditions. There are a number of ways to address these issues. One could be to adjust DLs and QLS to more realistic values; another, to modify the to section to consider the methods, or others alternate methods of sufficient sensitivity as required, but indicate the DLs and QLS as guidelines. We suggest this topic may warrant a more detailed discussion with several of Ecology's units and our Laboratory professional. We look forward to initiating any additional meetings to address this issue.	The change from the Appendix A as ... the following table with analytical levels is to be used as guidance for effluent characterization NPDES permit applications and applications for permit renewal. To "The Permittee must use the specified analytical methods, DLs and QLS in the following table for permit and applications requirements.... If the permittee uses an alternative method, not specified in the permit ... If the permittee is unable to obtain the required DL and QL in its effluent due to matrix effects, the permittee must submit a matrix-specific DL and QLS Ecology with appropriate lab documentation."	Betsy Cooper	Revised RDLs/MDLs according to KC's request

Number	Page	Section/ permit or factsheet	KC Comments	KC Suggested Resolution/Change	KC commenters name	Ecology Response
15	15	S2.C.-3	the specific bullets under the requirement to calibrate consistent with manufacturer's recommendations create some unrealistic logistical challenges as written.	The current calibration measures used are consistent with the manufacturer's recommendations. The specifics listed in the bullet in the draft permit are not fully compliant with Manufacturers Specifications. Therefore we would request removing bullet a,b,c from the permit and just leaving the basic sentence.	Eugene Suglia	The following text was removed: a. May calibrate apparatus for continuous monitoring of dissolved oxygen by air calibration. b. Must calibrate continuous pH measurement instruments using a grab sample analyzed in the lab with a pH meter calibrated with standard buffers and analyzed within 15 minutes of sampling. c. Must calibrate continuous chlorine measurement instruments using a grab sample analyzed in the laboratory within 15 minutes of sampling.
16	16	S3A-7	a. Submit monthly DMRs by the 15th - Preparing reports for the TP and four CSO facilities, by the 15th, is challenging. b. Submit annual DMRs by March 30th...First need to clarify if this is the CSO Treatment Plant DMRs? - can be done but would then be a separate submittal from the CSO annual report.	a. propose retaining the 20th as in the current permit. b. propose submitting the annual DMRs with the CSO annual reports, and their due date.	Eugene Suglia	15th for monthly - changed annual DMR submittal to July 31st, consistent with annual report.
29	30	S6.D.	As sufficient data become available, the Permittee must, in consultation with Ecology, reevaluate their local limits in order to prevent pass through or interference. On a case-by-case basis, as applicable, the Permittee should consider the impacts of CSO discharges on the receiving waterbody when establishing limits for individual Permittees. If Ecology determines that any pollutant present causes pass through or interference, or exceeds established sludge standards, the Permittee must establish new local limits or revise existing local limits as required by 40 CFR 403.5. Ecology may also require the Permittee to revise or establish local limits for any pollutant discharged from the treatment works, including CSO outfalls (treated or untreated, controlled or uncontrolled), that has a reasonable potential to exceed the water quality standards, sediment standards, or established effluent limits, or causes whole effluent toxicity. Ecology makes this determination in the form of an Administrative Order.	We propose that Ecology remove reference to a requirement to apply <i>local limits</i> based on CSOs and revise the section to be clear that <i>individual permits limits</i> will include CSO considerations where applicable and only on a case-by-case basis. The basis for local limits is for municipal wastewater treatment plants, not for CSO outfalls or for CSO treatment facilities. Therefore we suggest leaving the first added sentence as drafted but deleting <i>'including CSO outfalls(treated or untreated, controlled or uncontrolled)'</i> .	Despina Strong/Betsy Cooper	Kept sentence that starts with "On a case-by-case basis," since it refers to individual permits. Removed 'including CSO outfalls(treated or untreated, controlled or uncontrolled)' because of the difficulty of assessing the individual discharges impacts to a specific CSO discharges during large storm events.
33	36	S11.B.#7	New text proposed for 9 MC #7 call for two new activities - they are: In the second paragraph (The first Annual CSO Report submitted under this permit cycle must include a detailed description of the pollution prevention program, appropriate BMP's, and the legal authority and administrative procedures that will be used to ensure the program is being implemented. If the legal authority and/or administrative procedures are not in place, the first Annual CSO Report must include a detailed description of the steps needed to establish such a program and the timeline for getting the program in place.) 1) the need to clarify the legal and administrative procedures in place to address stormwater BMP in combined areas. The third paragraph (In addition, every Annual CSO Report must contain a list of facilities that discharge, or have the potential to discharge, industrial stormwater into the combined sewer system.) 2) proposes new reporting of information on industrial discharge stormwater discharges. We would like to discuss each.	Regarding topic 1) it is our understanding that the term 'first annual CSO report submitted under this permit cycle' would mean the first full year under this permit so the report would be submitted in July 31 2016. While KC has committed to clarifying the regulatory and administrative authority for these SW source control in the Duwamish in the proposed KC Duwamish 5-year Source Control plan, we proposed clarifying the roles and responsibility by 2017 therefore we would request that the permit be consistent with that commitment.	Betsy Cooper	Added clarification that this requirement will start with the Annual Report submitted in 2016.
34	37	S11.B.#7	New text proposed for 9 MC #7 call for two new activities - they are: In the second paragraph (The first Annual CSO Report submitted under this permit cycle must include a detailed description of the pollution prevention program, appropriate BMP's, and the legal authority and administrative procedures that will be used to ensure the program is being implemented. If the legal authority and/or administrative procedures are not in place, the first Annual CSO Report must include a detailed description of the steps needed to establish such a program and the timeline for getting the program in place.) 1) the need to clarify the legal and administrative procedures in place to address stormwater BMP in combined areas. The third paragraph (In addition, every Annual CSO Report must contain a list of facilities that discharge, or have the potential to discharge, industrial stormwater into the combined sewer system.) 2) proposes new reporting of information on industrial discharge stormwater discharges. We would like to discuss each.	Regarding topic 2) to comply with such a requirement is complicated by conflicting definitions of "industrial users" by various authorities (KC pretreatment program, Ecology/SW manual and NS4 permit, Seattle SW code) and KC's limited ability to have knowledge of many facilities that might have stormwater discharges since KC does not have jurisdiction over stormwater or land use (building or occupancy permits) in the City limits. Other than providing basic information regarding the general zoning and land use types in the areas of the CSO basins, KC does not appear to be able to have the ability to provide this data sought in this condition. Therefore we request this proposed requirement be deleted from the permit.	Betsy Cooper	Removed second sentence ("in addition ..."), due of difficulty in tracking down individual industrial stormwater contributors (many and new ones every year). Start with first part of requirement now with thoughts on second for next permit.
35	37	S11.C. CSO Reporting	1. monthly reporting by the 15th of the month	As requested for the full DMR, in recognition of the 4 CSO treatment plants, as well as the data for 38 flow monitoring activities and additional control facilities coming on line during this permit cycle we request that having all report in, QCD and submitted by the 15th of the month would be extremely difficult and request the 20th date be maintained, as it has been in all previous permits.	Betsy Cooper	Must be consistent with all other permittees and have DMRs submitted by the 15th of each month.

Number	Page	Section/ permit or factsheet	KC Comments	KC Suggested Resolution/Change	KC commenters name	Ecology Response
40	42	S13B	The adopted Post-Construction Monitoring plans states "Post construction sediment monitoring comprises a combination of modeling and sediment quality samples that provide a site characterization. King County, in consultation with Ecology, will determine what comprises an adequate site characterization on a site specific basis. Based on the site characterization, certain CSO discharge locations may exceed Sediment Management Standards (SMS). For these locations, a site-specific sediment cleanup plan will be developed. Cleanup plans will contain actions required to meet the Sediment Management Standards (SMS) as well as a sampling program to ensure the outcome has been achieved and recontamination is not occurring."	Clarify the language in the first paragraph of S13B on sediment characterization at controlled CSOs to indicate that <i>sampling or modeling</i> can be used (similar to the language used in the second paragraph on monitoring).	Jeff Stern	Added text "model and/or collect sediment samples"
42	43	S13Bb	Data reports are requested 8 months after sample collection. While this is possible, if there are competing projects or unexpected requests that compete for lab or staff time (other than the norm), this timing will be extremely difficult to meet.	Please change report due date to 10 months after collection.	Jeff Stern	Due date changed to 10 months after collection.
43	44	S15. EW Copper Reduction assessment	This new condition calls for KC to, among other things, "Assess copper discharge patterns such as seasonal or first flush impacts, stormwater vs. domestic wastewater concentrations, etc. We would like to discuss what is expected and what we think is possible to address "stormwater vs domestic wastewater concentrations, etc."	We believe the assessment could characterize, in the EW drainage basin sample areas with particular development patterns (predominantly industrial, industrial/commercial, residential) and look at copper concentrations during wet and dry periods, but we do not see a way to assess "stormwater vs domestic wastewater concentrations". We request a revision of that conditions.	Betsy cooper	Thanks for the feedback. Language changed accordingly.
47	53-57	Appendix A	As noted earlier, and supported by information provided regarding the methods currently and continuously used for years by our Process Control labs and Environmental Labs. There are a number of methods we use that are not in the Appendix A table. Also the DLs and QLS in some cases do not appear to be consistently achievable.	We request a larger discussion about how to address are significant concerns with the changes to this section and how they would affect KC's ability to comply with this permit.	Betsy cooper	Added following language to App A: "Alternative methods may be used if the Permittee knows that an alternate, less sensitive method (higher DL and QL) from those listed below is sufficient to produce measurable results in their effluent." Also: OK to use if EPA has granted the laboratory written permission to use the method". also: Appendix A methods required for parameters with Limits. For parameters w/o limits, use method with similar detection level."
48	Appendix A 53	Additional Ammonia Methodology	Please add Ammonia method "Kerouel & Aminot 1997" to the Recommended Analytical Protocol column in Appendix A. KCEl has received permission from EPA to use this fluorometric method for all ammonia samples analyzed at KCEl but it is not listed in 40 CFR 136.	for all Lab comments, suggested resolution is in Comment column	Brian Prosch	
49	Appendix A53	Additional Fluoride	For Fluoride, please add ion chromatography method SM4110B to the Recommended Analytical Protocol column in Appendix A. This method was in Appendix A from the previous West Point NPDES permit.	for all Lab comments, suggested resolution is in Comment column	Brian Prosch	Fluoride deleted from table.
51	Appendix A 54	Update Total Phosphorus DL & QL	For total phosphorus, the DL and QL values should be updated to 100 ug/L each, as in Appendix A from the previous West Point NPDES permit. These limits should be no lower than the soluble reactive phosphorus limits of 100 ug/L.	for all Lab comments, suggested resolution is in Comment column	Brian Prosch	Updated table for this discharger since 0.1 mg/L provides sufficient sensitivity.
52	Appendix A 54	Update Settleable Solids QL	For Settleable Solids, please update the QL to 1000 ug/L since 100 ug/L is too low to be detected by SM2540-F.	for all Lab comments, suggested resolution is in Comment column	Brian Prosch	Updated table - permit specific
54	Appendix A 54	Additional Total Cyanide Methodology	For Total Cyanide, please add method SM4500-CN-C-E to the Recommended Analytical Protocol column in Appendix A. It is an approved method under 40 CFR 136 and is the reference method used by KCEl.	for all Lab comments, suggested resolution is in Comment column	Brian Prosch	Added.
57	Appendix A 54	Iron, Total	Please add 200.8 to the list of recommended protocols.	for all Lab comments, suggested resolution is in Comment column	Diane McElhany	Added.
58	Appendix A 54	Magnesium, Total	Please add 200.8 to the list of recommended protocols.	for all Lab comments, suggested resolution is in Comment column	Diane McElhany	Added.
59	Appendix A 56	1,2- Diphenylhydra zine (as Azobenzene) has only method 1625 listed. This is an isotope dilution method.	Please add 625 to the list of protocols.	for all Lab comments, suggested resolution is in Comment column	Diane McElhany	Added.
61	Appendix A (in general)	Appendix A (in general)	EPA is in the process of revamping many of the 40 CFR methods listed in Appendix A including 608, 624 and 625. These methods have not been updated in over 25 years. I'd suggest that Appendix A reflect the current EPA DLs and/or be open to including the new detection limits when these methods are finally promulgated.	for all Lab comments, suggested resolution is in Comment column	Diane McElhany	Addressed by line 50 above.
62	Appendix A 53	Matrix specific MDL study when DL and DL/QLs are higher due to matrix effects.	Can you give more details in terms of exactly what types of documentation are you expecting to see? Are you asking for an MDL study in the eact matrix? Final treatment plant effluent is fairly consistent, however CSO effluent can be very inconsistent making the achievable DLs and QLS variable. We'd like to discuss how best to approach this issue with DOE prior to the new permit.	for all Lab comments, suggested resolution is in Comment column	Diane McElhany	Addressed with specific statement about matrix problems for CSO influent/effluent.

Number	Page	Section/ permit or factsheet	KC Comments	KC Suggested Resolution/Change	KC commenters name	Ecology Response
63	Appendix A 54	Chromium (hex) dissolved was added under the Priority Pollutants (Metals, Cyanide and Total Phenols).	Hexavalent chromium is not listed in the EPA priority pollutant list (40 CFR, Part 423, Appendix A), just Total Chromium. If hexavalent chromium should be added to this Appendix A, could it be added to the NONCONVENTIONAL PARAMETERS grouping instead of the PRIORITY POLLUTANTS heading?	for all Lab comments, suggested resolution is in Comment column	Diane McElhany	removed Priority Pollutants title
64	Appendix A 54	Clarification of Chromium (hex) dissolved methodology	I am not sure which method is meant by SM3500-Cr EC since there is no method E for SM3500. Do you mean SM3500-Cr C?	for all Lab comments, suggested resolution is in Comment column	Brian Prosch	Chromium Hex changed to SM3500-CR C
65	Appendix A 54	Additional Chromium (hex) dissolved methodology	Please add SM3500-Cr B to the Recommended Analytical Protocol column in Appendix A for Chromium (hex) dissolved. It is an approved method in 40 CFR 136 and KCEL is accredited for this method. The DL and QL for this method should be listed as 5 and 10 ug/L, respectively.	for all Lab comments, suggested resolution is in Comment column	Brian Prosch	Added.
67		Permit Effective date	If we find that the effective date will fall somewhere in December, will Ecology consider making the date in January? This would allow a tidy reporting on annual reports, etc. avoiding requirement spanning the last month of the year.	see comments	Pedro De Arreaga/ Betsy Cooper	Will do.
Fact Sheet Comments						
15	35	Table 18 EW	Copper Ecology value 86.7 KC value 71.4 in max column; Cadmium Ecology value 0.617 KC value 0.349 in max column; Weak Dissociable Cyanide Ecology value 11.8 KC value 19.3 in Max column all units ug/l		Fritz Grottkoff	Copper: Sample collected 8/24/09 was reported as 86.7 ug/L. Cadmium: Sample collected 8/24/09 was reported as 0.617 ug/L. Weak dissociable cyanide: Value should be 19.3 as pointed out, table and RP calc updated.

Public Review Comments

Ecology received two comments during the 30-day public review period: one from EPA Region 10 and the other from Seattle Public Utilities.

Comment #1: EPA

The U.S. Environmental Protection Agency reviewed the above-referenced draft permit pursuant to the NPDES Memorandum of Agreement between the Washington Department of Ecology and United States Environmental Protection Agency Region 10 (MOA) and the EPA's obligation to oversee implementation of the NPDES programs by delegated states. The EPA reviewed the draft permit for consistency with the Clean Water Act and NPDES implementing regulations and with the Department of Ecology's (Ecology) regulations and permit writing guidance.

The EPA completed a screening-level review of the above-mentioned draft NPDES permit. Although our review was not comprehensive, the following concern must be addressed to ensure consistency with the CWA and NPDES regulations.

The proposed draft permit removes discharge event maximum settleable solids effluent limits of 1.9 mL/L for all four CSO treatment plant discharges. Presumably these limits were developed in a previous version of the NPDES permit as a technology-based effluent limit based on best professional judgment (BPJ). CWA section 402(o) expressly prohibits backsliding from certain existing effluent limitations. The fact sheet must explain how removal of these effluent limits is consistent with CWA section 402(o) and exceptions to the general prohibition outlined in part (2) of that section or anti-backsliding regulation at 40 CFR 122.44(l). Refer to EPA's Permit Writers' Manual (http://www.epa.gov/npdes/pubs/pwm_2010.pdf), section 7.2, for information about applying the anti-backsliding provisions in NPDES permitting.

Please let me know if you have any questions regarding these comments. Sincerely, Karen

KAREN BURGESS, P.E.

NPDES Permits Unit - State Oversight Lead
EPA Region 10

206-553-1644 | Burgess.Karen@epa.gov

U.S. Environmental Protection Agency
Office of Water and Watersheds, M/S OWW-130
1200 Sixth Avenue, Suite 900
Seattle, Washington 98101
<http://www.epa.gov>

Ecology's response to Comment #1:

Ecology proposes to regulate settleable solids discharges from the CSO treatment plants in King County's collection system using the annual average limit of 0.3 mL/L/hr instead of both the per event limit of 1.9 mL/L/hr and annual average limit of 0.3 mL/L/hr, as instated in the previous permit.

The Clean Water Act (CWA) section 402(o) expressly prohibits backsliding from certain existing effluent limits including:

1. To revise an existing technology-based effluent limit (TBEL) that was developed on a case-by-case basis using best professional judgment (BPJ) to reflect subsequently promulgated effluent limitations guidelines and standards (effluent guidelines) that would result in a less stringent effluent limitation, and

2. Relaxation of an effluent limitation that is based on state standards, such as water quality standards or treatment standards, unless the change is consistent with CWA section 303(d)(4).

The discharge event maximum settleable solids limit that Ecology is proposing to remove is not a state standard (i.e. not in state regulation) and is not a guidance-based or a water quality-based limit, but instead a case-by-case limit developed using best professional judgment (BPJ).

Therefore the exception allowances of 40 CFR 122.44(l) apply.

40 CFR 122.44(l)(2)(i)(B)(1) allows an exception to anti-backsliding policies when “information is available which was not available at the time of permit issuance (other than revised regulations, guidance, or test methods) and which would have justified the application of a less stringent effluent limitation at the time of permit issuance”. When Ecology originally issued the settleable solids per event limit of 1.9 mL/L/hr it was unaware of the extreme variability in volume and quality (physical and chemical characteristics) of CSO influent flows. In addition, the event maximum limit appears to have been developed with data for continuously operated facilities (i.e. Carkeek primary plant), which does not fit the intermittently operated CSO facilities. The CSO treatment plants cannot always meet the treatment demands of these highly fluctuating, intermittent influent flows when averaged over short periods such as 1 to 2 hours as is often the case for CSO events. This especially applies when “first flush” conditions occur and settleable solids levels are particularly high. Averaging treatment performance over a longer time period provides a more representative assessment of a facility’s performance capability under these instances. Therefore Ecology is proposing to require the annual average limit of 0.3 mL/L/hr and not include the maximum per event limit.

This decision is consistent with Ecology’s regulation to require on-site treatment of CSOs to provide treatment equivalent to primary treatment which is defined in WAC 173-245-020(16) as “any process which removes at least 50% of the total suspended solids from the waste stream, and discharges less than 0.3 mL/L/hr of settleable solids”. The proposed permit restricts the facility to an annual average limit of 0.3 mL/L/hr to meet this design standard.

The removal of the discharge event maximum settleable solids limit for the four CSO satellite treatment plants is consistent with CWA section 402(o) and exceptions to the general prohibition outlined in anti-backsliding regulation at 40 CFR 122.44(l).

Comment #2: Seattle Public Utilities



City of Seattle
Seattle Public Utilities



November 24, 2014

Washington State Department of Ecology
Northwest Regional Office
3190 - 160th Avenue SE
Bellevue, WA 98008-5452

Permit Coordinator:

The City of Seattle provides the following comment on Draft Wastewater Permit No. WA0029181, to be issued to the King County Department of Natural Resources and Parks for the West Point Wastewater Treatment Plan.

Page 36 of 55, Section S11.B, Paragraph 7. Implement a pollution prevention program focused on reducing the impact of CSOs on receiving waters. **Best management practices (BMPs) to control pollutant sources in stormwater in CSO basins must be an element of the pollution prevention program. Ecology's Stormwater Management Manual for Western Washington (2012) contains applicable BMPs, or equivalent manuals- shall be used as a reference for identifying appropriate BMPs.** Starting with the Annual CSO Report submitted in 2017, **the Permittee must include a detailed description of the pollution prevention program, appropriate BMPs, and the legal authority and administrative procedures that will be used to ensure the program is being implemented. If the legal authority and/or administrative procedures are not in place, the Annual CSO Report must include a detailed description of the steps needed to establish such a program and the timeline for getting the program in place.**

With regard to the term "applicable BMPs," Ecology's Stormwater Management Manual for Western Washington (2012) refers to "applicable BMPs" as "Mandatory" or "must be included." (e.g., Vol. IV, 1-3 to 1-4) Seattle requests that the permit language be changed to reflect that the Manual shall be used as a reference to identify the "appropriate BMPs," the term used later in Paragraph 7. In some cases, these "mandatory" requirements designed for use in separate storm sewer areas are not the best management practice for controlling pollutants to a combined sewer system.

Cordially,

A handwritten signature in cursive script that reads "Nancy Ahern".

Nancy Ahern, Director
Utility System Management Branch
Seattle Public Utilities

cc: Pam Elardo, WTD Director, King County

Ray Hoffman, Director
Seattle Public Utilities
700 5th Avenue, Suite 4900
PO Box 34018
Seattle, WA 98124-4018

Tel (206) 684-5851
Fax (206) 684-4631
TDD (206) 233-7241
ray.hoffman@seattle.gov

<http://www.seattle.gov/util>

An equal employment opportunity, affirmative action employer. Accommodations for people with disabilities provided on request.

Ecology's response to Comment #2

Ecology has revised the sentence to indicate "appropriate BMPs" instead of "applicable BMPs". Ecology did not intend to invoke the meaning of "applicable" as used in Volume IV of Ecology's Stormwater Management Manual for Western Washington (2012).

Ecology agrees that stormwater management manuals approved by Ecology under a Phase I Municipal Stormwater Permit also contain appropriate BMPs. Such BMPs are determined to be functionally equivalent to the relevant portion of Ecology's Stormwater Management Manual for Western Washington through a process associated with the Phase I Municipal Stormwater Permit.

For this CSO-related permit requirement, Ecology agrees that use of Ecology's Stormwater Management Manual for Western Washington and/or use of functionally equivalent manuals approved by Ecology under a Phase I Municipal Stormwater Permit is acceptable for reference purposes in identifying "appropriate" BMPs.

Ecology would also like to provide the following definitions of stormwater BMPs:

Stormwater Best Management Practices (BMPs) means schedules of activities, prohibitions of practices, maintenance procedures, and structural and/or managerial practices to prevent or reduce the release of pollutants. BMPs include treatment systems, operating procedures, and practices to control: facility site runoff, spillage or leaks, sludge or waste disposal, or drainage from raw material storage.

Equivalent BMPs means operational, source control, treatment or innovative BMPs which result in equal or better quality of stormwater discharge from a site than BMPs selected from the Ecology Stormwater Management Manual for Western Washington.